

MARK 記号	REVISION 来歴	DATE 年月日	SIGN 担当	APP. 承認

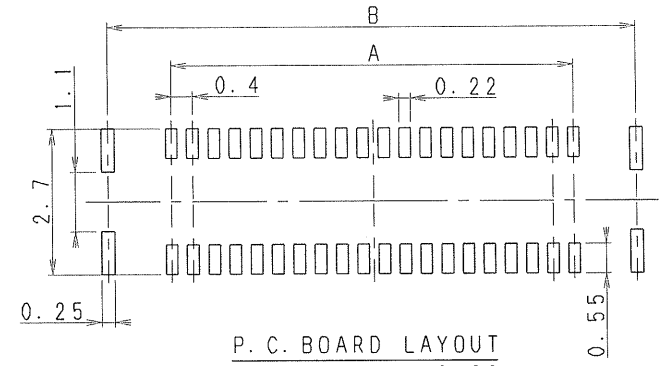

P. C. BOARD LAYOUT  
Tolerance: ±0.03

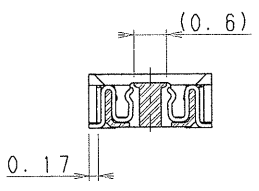
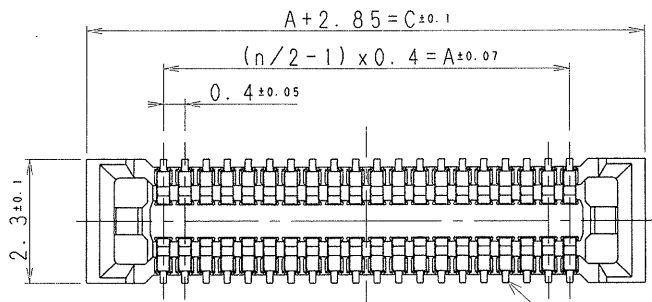
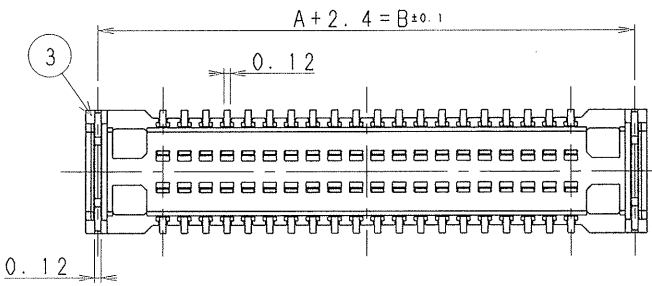
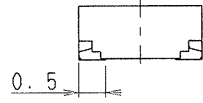
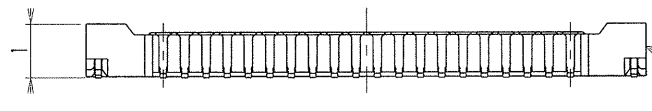

70	13.6	16.0	16.45
60	11.6	14.0	14.45
50	9.6	12.0	12.45
44	8.4	10.8	11.25
40	7.6	10.0	10.45
36	6.8	9.2	9.65
34	6.4	8.8	9.25
30	5.6	8.0	8.45
26	4.8	7.2	7.65
24	4.4	6.8	7.25
20	3.6	6.0	6.45
18	3.2	5.6	6.05
16	2.8	5.2	5.65
14	2.4	4.8	5.25
10	1.6	4.0	4.45
XX(n)	A	B	C

NOTE  
 1. SPECIFICATION: CPB0310B0150F  
 2. PACKAGE: CPB03XXN0159F  
 3. COPLANARITY: 0.08max  
 4. CONTACT PLATING (with Ni barrier)  
 Contact point: Au0.1μmMIN  
 Soldering point: Au0.03-0.2μm

3	501CPB-022-90F	HOLD DOWN	Cu ALLOY	SnAsCuPLATE	2	
2	415CPB-096-ZZF	CONTACT	Cu ALLOY	AuPLATE	n	n=XX
1	101CPB-135-XXF	HOUSING	LCP (GF)	BLACK	1	
ITEM 部番	PART NO. 番	NAME 名称	MATERIAL 材質	FINISH 処理	Q'TY 員数	NOTE 備考
UNIT 単位	mm	SCALE 尺度	10:1	DESCRIPTION 名称	0.4mm PITCH B-B CN	ISSUED 出
APPROVED 承認	CHECKED 検	TRACED 写	DESIGNED 設計	4306	PB-4H SOCKET	ISSUED 出
Mar 22 '16		Mar 22 '16		S. Koike		DESIGN NO. 番
C:PB03XX-0159F						

15 DIMENSIONS RANGE	TOLERANCE UNLESS SPECIFIED
0-5 ≤ X < 1	±0.15
1 ≤ X ≤ 6	±0.20
6 < X ≤ 18	±0.30
18 < X ≤ 50	±0.50
50 < X ≤ 120	±0.70
120 < X ≤ 250	±0.90
250 < X ≤ 500	±1.20

ISSUED  
出  
MAR 22 2016  
DESIGN DEPT.

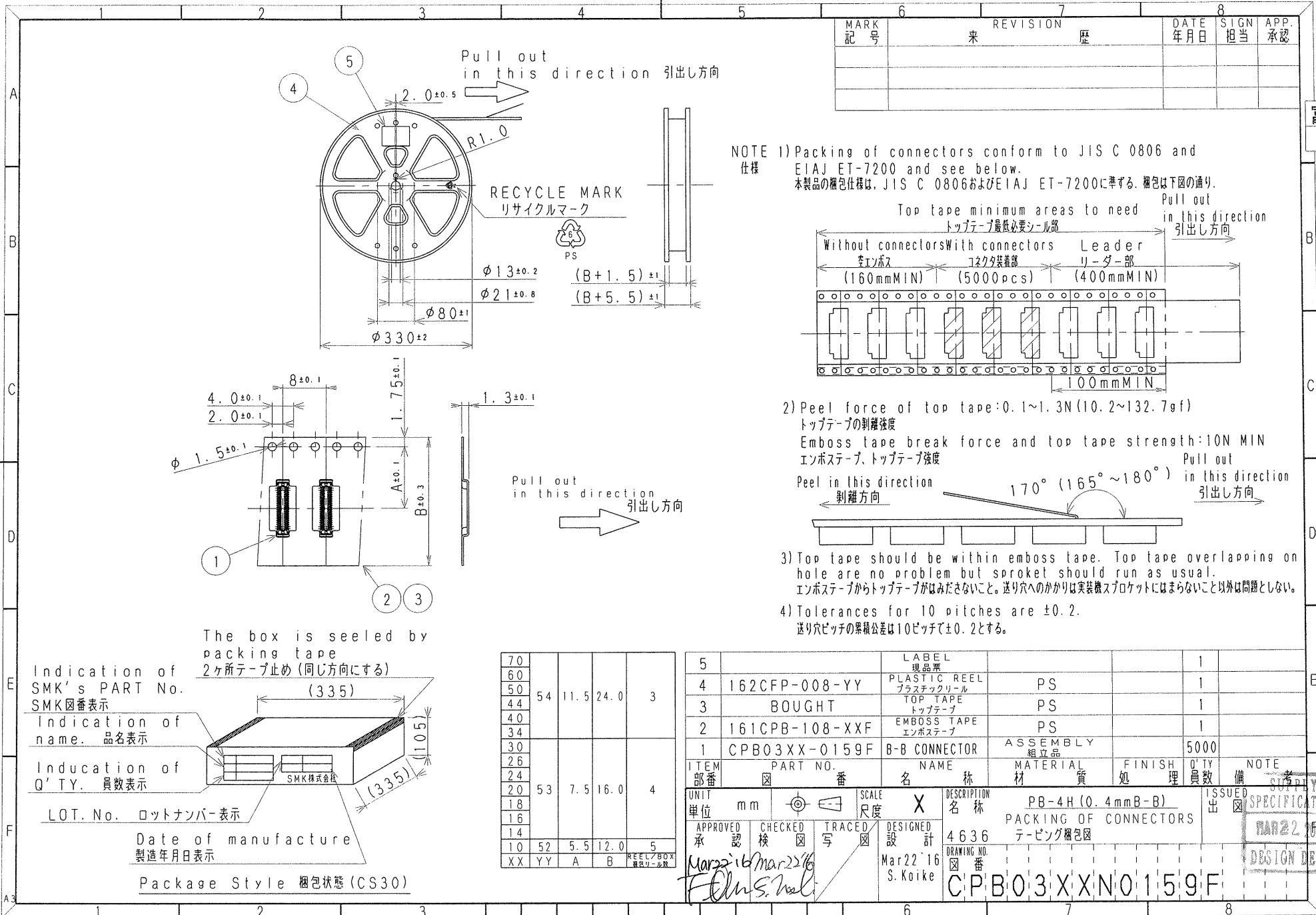

MARK 記号	REVISION 来歴	DATE 年月日	SIGN 担当	APP. 承認

NOTE 1) Packing of connectors conform to JIS C 0806 and EIAJ ET-7200 and see below.  
 本製品の梱包仕様は、JIS C 0806およびEIAJ ET-7200に準ずる。梱包は下図の通り。

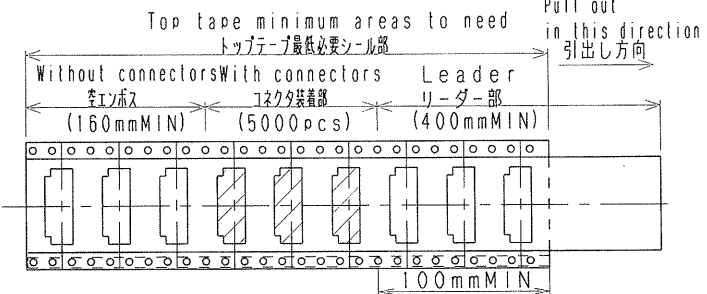

- 2) Peel force of top tape:  $0.1 \sim 1.3\text{N}$  (10.2~132.7gf)  
 トップテープの剥離強度  
 Emboss tape break force and top tape strength:  $10\text{N MIN}$   
 エンボステープ、トップテープ強度  
 Peel in this direction  
 剥離方向  
 Pull out in this direction  
 引出し方向  
 170° (165°~180°)
- 3) Top tape should be within emboss tape. Top tape overlapping on hole are no problem but sprocket should run as usual.  
 エンボステープからトップテープがはみださないこと。送り穴へのかりは実装微スプロケットにはまらないこと以外は問題としない。
- 4) Tolerances for 10 pitches are  $\pm 0.2$ .  
 送り穴ピッチの累積公差は10ピッチで $\pm 0.2$ とする。

Indication of SMK's PART No.  
 SMK図番表示

Indication of name.  
 品名表示

Indication of Q'TY.  
 員数表示

LOT. No. ロットナンバー表示

Date of manufacture  
 製造年月日表示

Package Style 梱包状態 (CS30)

The box is sealed by packing tape  
 2ヶ所テープ止め (同じ方向にする)

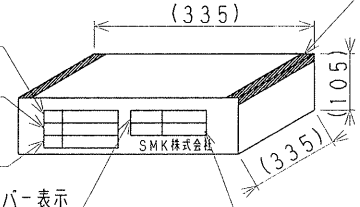

70					
60					
50	54	11.5	24.0	3	
44					
40					
34					
30					
26					
24					
20	53	7.5	16.0	4	
18					
16					
14					
10	52	5.5	12.0	5	
XX	YY	A	B		REEL/BOX

5		LABEL 現品票			1	
4	162CFP-008-YY	PLASTIC REEL プラスチックリール	PS		1	
3	BOUGHT	TOP TAPE トップテープ	PS		1	
2	161CPB-108-XXF	EMBOSS TAPE エンボステープ	PS		1	
1	CPB03XX-0159F	B-B CONNECTOR	ASSEMBLY 組立品		5000	
ITEM 部番	PART NO. 図番	NAME 名称	MATERIAL 材質	FINISH 処理	Q'TY 員数	NOTE 備
UNIT 単位	mm	SCALE 尺度	X	DESCRIPTION 名称	PB-4H (0.4mmB-B)	
APPROVED 承認	CHECKED 検	TRACED 写	DESIGNED 設計	PACKING OF CONNECTORS テーピング梱包図		
				DRAWING NO. 図番	4636	
					Mar22'16 S. Koike	
				C/P/B/03XX/N/0159F		

SECTION IN CHARGE 主管	SPECIFICATION FOR 0.4mmPitch B-B CONNECTOR	CLASSIFICATION No.	4306	1/8
		分類番号		
CONNECTOR DIVISION コネクタ(事)設計部	0.4mmPitch B-B コネクタ仕様書	DRAWING No. CPB0310B0150F		

富

1.Scope This specification presents the performance of 0.4mmPitch B-B connector

適用範囲 本仕様書は0.4mmピッチB-Bコネクタに適用する。

Drawing No.

適用図番 CPB03XX-YYYYY CPB04XX-YYYYY

2.Characteristics

性能

>Standard atmospheric condition

標準状態

Unless otherwise specified, the standard range of atmospheric conditions for making measurements and tests are as follows:

特に指定がない限り、測定は以下の条件にて行う。

Ambient temperature (常温) : 5°C to 35°C  
 Relative humidity (常湿) : 45%RH to 85%RH  
 Air pressure (常気圧) : 86kPa to 106kPa

If there is any about the result, measurements shall be made within the following limits:

ただし、判定に疑義を生じた場合、測定は以下の条件にて行う。

Ambient temperature (常温) : 20 +/- 2°C  
 Relative humidity (常湿) : 60%RH to 70%RH  
 Air pressure (常気圧) : 86kPa to 106kPa

>Operating temperature range

使用温度範囲

Operating temperature range is the range of ambient temperature for the connector housing which can be operated continuously at rated voltage and rated current.

定格電圧・電流で連続して使用可能な周囲温度の範囲。

-40°C to 85°C

>Storage temperature and relative humidity range

保存温度・保存湿度範囲

Storage temperature and relative humidity range is the range of ambient temperature and which the connector housing can be stored without load.

-55°C to 85°C , 15%RH to 70%RH

>Keeping period 保管期間

6months from shipment day

出荷日から6ヶ月

3. Country of origin 生産国

JAPAN(TOYAMA) 日本(富山)

△ x 1	Change of Insertion/Withdrawal force	Jan05'12	Shimada		ISSUED 発行	APPROVED 承認	CHECKED 照査	DRAWN 作成
		MARK 記号	REVISION 来歴	DATE 日付				
APPROVED 承認		EXECUTE 実施						

Jan 5 '12  
 Jan 05 '12  
 Jan 05 '12  
 Y. Shimada

SMK

RoHS Compliant 1

2012.1.16 09:16:53  
10975

2016.12.21 16:44:50  
5204

2.1 Electrical characteristics 電氣的性能			
	ITEMS 項目	CONDITIONS 条件	SPECIFICATIONS 規格
1	Rated voltage / Rated current 定格電圧		AC/DC 50V, 0.3A
2	Contact resistance 接触抵抗	Connect with applicable connector, then contact resistance shall be measured between each coupled terminals. コネクタを嵌合し各端子間を測定する。 (但し、導体抵抗は除く)	30mΩ or less 以下
3	Insulation resistance 絶縁抵抗	100V DC shall be applied for 1 minute, then measurement shall be made. DC100V、1分後	Between conductors. 導体相互間 100MΩ or more 以上
4	Withstand voltage 耐電圧	100V AC shall be applied for 1 minute, then measurement shall be made. AC100V、1分後 Cut off current; 2mA 遮断電流	Between conductors. 導体相互間 Without damages such as arc or breakdown etc.

2.2 Mechanical characteristics 機械的性能			
1	Insertion force 総合挿入力	Measurement the insertion force of socket and plug. プラグとソケットを嵌合させるときの力を測定。	Refer Table 1
2	Withdrawal force 総合抜去力	Measure the withdrawal force of socket and plug プラグとソケットを離脱させるときの力を測定。	Refer Table 1
3	Terminal retention force 端子抜け強度	The retention force when the terminal is extracted from connector housing shall be measured. 各端子がコネクタハウジングから抜ける時の力を測定する。	0.5 N or more 以上

Table 1

	Insertion force 総合挿入力	Withdrawal force 総合抜去力	
		First	After 10 times
10	30 N or less	4.0 N or more	
14	42 N or less	5.6 N or more	
16	24 N or less	4.0 N or more	
20	30 N or less	5.0 N or more	
24	36 N or less	6.0 N or more	
26	39 N or less	6.5 N or more	
30	45 N or less	7.5 N or more	
34	34 N or less	5.1 N or more	
36	36 N or less	5.4 N or more	
40	40 N or less	6.0 N or more	
50	50 N or less	7.5 N or more	
60	60 N or less	9.0 N or more	
70	70 N or less	10.5 N or more	

SMK

2012.1.16 09:16:53  
10975

2016.12.21 16:44:50  
5204

2.3 Endurance characteristics 耐久性能			
Test shall be performed in mated condition with mating applicable FPC. 試験は適合FPCと組み合わせた状態にて行う。			
ITEMS 項目	CONDITIONS 条件	SPECIFICATIONS 規格	
1 Cold 低温放置	After exposing to a temperature of -55+/-3°C for 96h, the specimen shall be subjected to standard atmospheric conditions for 1h, then measurement shall be made. For other procedures, refer to JIS C 60068-2-1. -40±3°C、96時間放置後取り出し、常温常湿中に1時間放置し測定する。 その他、JIS C 60068-2-1 に準拠。	Contact resistance 接触抵抗 60mΩ or less 以下	
2 Dry heat 高温放置	After exposing to a temperature of +85+/-2°C for 96h, the specimen shall be subjected to standard atmospheric conditions for 1h, then measurement shall be made. For other procedures, refer to JIS C 60068-2-2. +85±2°C、96時間放置後取り出し、常温常湿中に1時間放置し測定する。 その他、JIS C 60068-2-2 に準拠。	Contact resistance 接触抵抗 60mΩ or less 以下	
3 Damp heat 高温高湿	After exposing to a temperature of +60+/-3°C, a humidity in the range of 90%RH to 95%RH for 96h, the specimen shall be subjected to standard atmospheric conditions for 1h, then measurement shall be made. For other procedures, refer to JIS C 60068-2-3. 60±3°C、相対湿度90~95%、96時間後に取り出し、常温常湿中に1時間放置し測定する。 その他、JIS C 60068-2-3 に準拠。	(1)Contact resistance 接触抵抗 60mΩ or less 以下 (2)Insulation resistance 絶縁抵抗 DC 100V 1min.: 50MΩ or more (3)Withstand voltage 耐電圧 AC 100V 1min.: Without damage such as arc or breakdown etc.	
4 Thermal shock 熱衝撃	The connector shall be subjected to 5 successive change of temperature cycles each as shown in the table below. Then it shall be subjected to standard atmospheric conditions for 2h, then measurement shall be made. For other procedures, refer to JIS C 0025. 下記を1サイクルとして、5サイクル行う。 その後、常温常湿中に2時間放置し測定する。 その他、JIS C 0025 に準拠。 -55+/-3°C: 30min. Standard atmospheric condition: 5min. 85+/-3°C: 30min. Standard atmospheric condition: 5min.	Contact resistance 接触抵抗 60mΩ or less 以下	

SMK

2012.1.16 09:16:53  
10975

2016.12.21 16:44:50  
5204

CPB0310B0150F

No.4/8

	ITEMS 項 目	CONDITIONS 条 件	SPECIFICATIONS 規 格
5	Salt Spray 塩水噴霧	<p>The connector shall be subjected to a fine mist solution at a temperature of <math>35 \pm 2^\circ\text{C}</math> for 48h continuously. Salt solution concentration is <math>5 \pm 1\%</math> by weight. Then it shall be subjected to standard atmospheric conditions for 1h, and so measurement shall be made.</p> <p>For other procedures, refer to JIS C 60068-2-11.</p> <p><math>35 \pm 2^\circ\text{C}</math>、塩水濃度<math>5 \pm 1\%</math>(重量比)で48時間連続噴霧後、常温常湿中に1時間放置し測定する。 その他、JIS C 60068-2-11に準拠する。</p>	<p>(1)Contact resistance 接触抵抗 <math>60\text{m}\Omega</math> or less 以下</p> <p>(2)Without excessive rust 著しい錆がないこと。</p>
6	Shock 衝撃	<p>Pulse shape (波形) ; half sign (半正弦波) Peak acceleration (最大加速度) ; <math>490 \text{ m/s}^2(50\text{G})</math> Duration of the pulse (作用時間) ; 11 ms Three successive shocks shall be applied in both directions of 3 mutually perpendicular axis (total 18 shocks). X、Y、Z両方向に各3回、計18回 For other procedure, refer to JIS C 60068-2-27. その他、JIS C 60068-2-27 に準拠。</p>	<p>(1)Discontinuity: 不連続導通 <math>1 \mu\text{s}</math> or less 以下</p> <p>(2)Contact resistance 接触抵抗 <math>60\text{m}\Omega</math> or less 以下</p>
7	Vibration 振動	<p>The entire frequency range(周波数範囲) ; 10 to 55 to 10 Hz/min Amplitude (total excursion) (全振幅) ; 1.5 mm This motion shall be applied for a period of 2h in each of 3 mutually perpendicular axis (total 6h). X、Y、Z方向に各2時間、計6時間 For other procedures, refer to JIS C 60068-2-6. その他、JIS C 60068-2-6に準拠する。</p>	<p>(1)Discontinuity: 不連続導通 <math>1 \mu\text{s}</math> or less 以下</p> <p>(2)Contact resistance 接触抵抗 <math>60\text{m}\Omega</math> or less 以下</p>
8	Resistance to sulfuration 耐硫化性	<p>The connector shall be stored at a sulfuration gas ambience (<math>\text{H}_2\text{S}</math> <math>5+/-1\text{ppm}</math>) temperature of <math>40+/-2^\circ\text{C}</math> and relative humidity of 70%RH for 96h Continuously. Then the connector shall be maintained at standard atmospheric conditions for 1h after which measurement shall be made within 1h. 温度<math>40 \pm 2^\circ\text{C}</math>、相対湿度70%の硫化ガス雰囲気 (<math>\text{H}_2\text{S}</math> <math>5 \pm 1\text{ppm}</math>) 中に連続96時間放置後、常温湿中に1時間放置し、1時間以内に測定する。</p>	<p>(1)Contact resistance 接触抵抗 <math>60\text{m}\Omega</math> or less 以下</p> <p>(2)Without distinct damage in appearance. 外観に異常がないこと。</p>

SMK

2012.1.16 09:16:53  
109752016.12.21 16:44:50  
5204

CPB0310B0150F

No.5/8

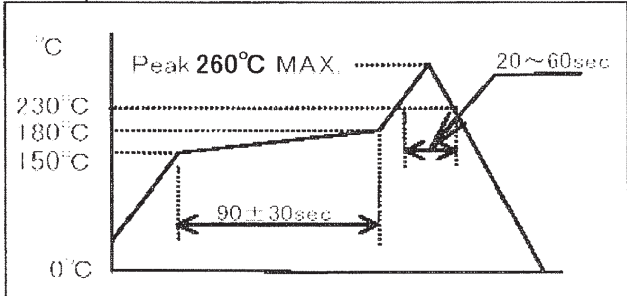
	ITEMS 項目	CONDITIONS 条件	SPECIFICATIONS 規格
9	Operating endurance.1 寿命耐久性.1	The measurement shall be made after having repeated this 50 times 適合プラグとソケットを50回挿抜する。 Test Condition:ref."The note when the product is mated(No.6/8~7/8)" 条件:コネクタ嵌合時の取り扱い注意参照 (No.6/8~7/8)	Contact resistance 接触抵抗 60mΩ or less以下
10	Operating endurance.2 寿命耐久性.2 (for test connector)  Drawing Number 対象図番 CPB03XX-0190F CPB04XX-0190F	The measurement shall be made after having repeated this 1000 times 適合プラグとソケットを1000回挿抜する。 Test Condition:ref."The note when the product is mated(No.6/8~7/8)" 条件:コネクタ嵌合時の取り扱い注意参照 (No.6/8~7/8)	Contact resistance 接触抵抗 100mΩ or less以下
11	Solderability はんだ付け性	Solder temperature: 235+/-5°C Immersion time: 2+/-0.5sec For other procedures, JIS C 60068-2-20. はんだ温度: 235±5°C 浸漬時間 : 2±0.5秒 その他、JIS C 60068-2-20 に準拠。	A new uniform coating of solder shall cover a minimum of 95% of the surface being immersed. はんだ浸漬面積の95%が新しいはんだで濡れていること
12	Resistance to soldering heat はんだ耐熱性	1)Reflow characteristics リフロー条件 The connector housing shall be stored at a temperature, each as shown in the chart below. 下記に示す温度にて加熱する。 <b>TEMPERATURE OF SURFACE P.C.B.</b>    2)Manual soldering using soldering iron Tip diameter: Selected to fit application Maximum tip temperature: 370°C Antistatic protection: Required Maximum exposure time: 3 sec  3)Manual hot gas soldering Max air temperature: 285°C Max air velocity: 10m/sec Max exposure time : 30sec	Without deformation of care or excessive looseness of terminals. 外観の変形及び端子などの著しいガタないこと。  Maximum number of reflow cycles: 2 cycles リフロー回数:2回MAX

SMK

2012.1.16 09:16:53  
10975

2016.12.21 16:44:50  
5204

The note when the product is mated.  
コネクタ嵌合時の取り扱い注意

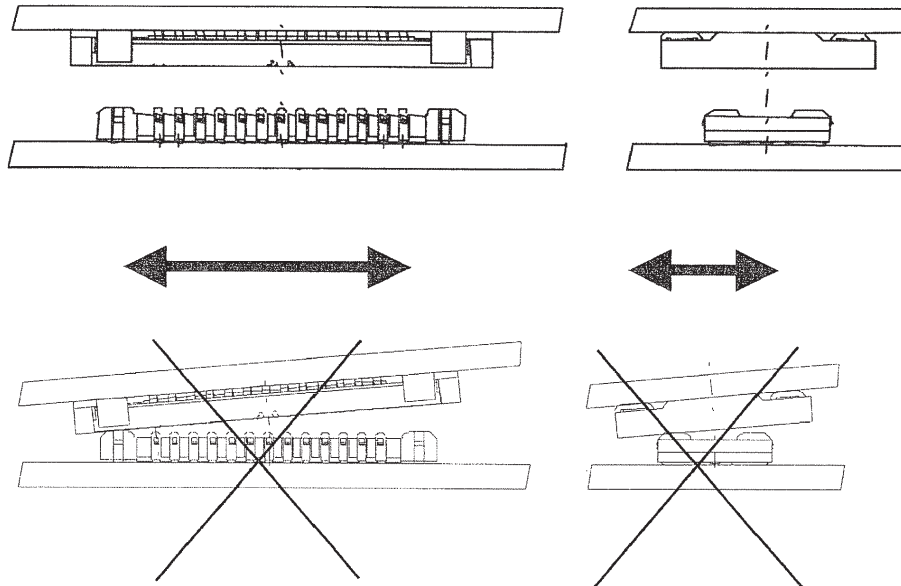

The product shall be free from excess force and must be mated on the vertical axis.  
These may break the mold and cause deformation.

無理な力を入れたり、斜めにした位置合わせは、  
モールドを破損させ、座屈を引き起こす原因になります。

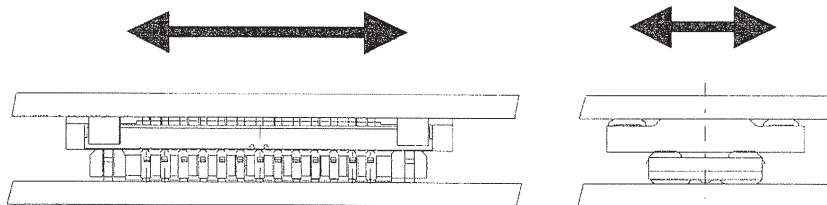

The connectors shall be positioned parallel when being positioned to be mated.

位置合わせをする際は、コネクタ同士を平行にして下さい。

SMK

2012.1.16 09:16:53  
10975

2016.12.21 16:44:50  
5204



### The note when the product is mated. コネクタ抜去時の取り扱い注意

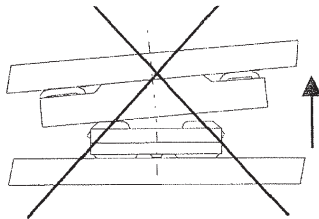
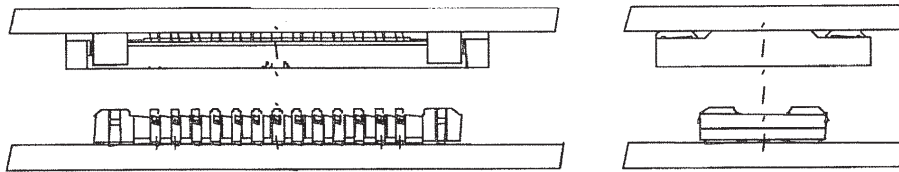

side as the drawing on left. The connectors may be impaired.

左図のように幅寸法から抜去を行うと、コネクタに損傷を与える恐れがあります。幅方向からの抜去は行わないで下さい。

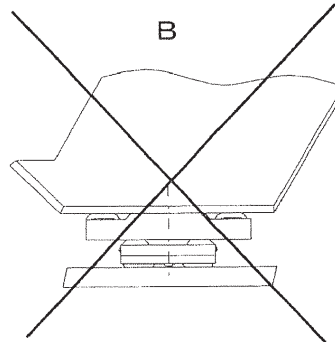
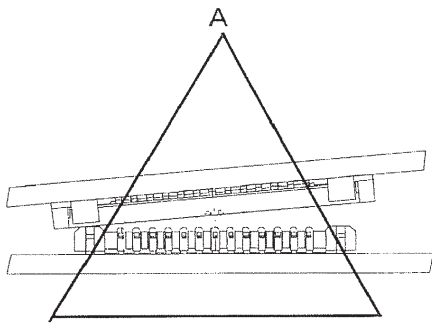

Please extracted as figure. A, under the condition that the connectors cannot be extracted parallel. However, please note that the extraction as figure. A may load largely on the end of the contacts when mounting on FPC and not enough rigidity. Moreover, please do not extract as figure. B, it loads excessively on the end of the contacts.

取り扱い上、平行に抜くことが出来ない場合には、上の図Aのように抜いてください。但し、FPCに実装の場合で剛性がない場合は、端の端子に負荷が集中しますので、ご注意願います。特に上の図Bのようなコーナーからの抜去は、端の端子に大きな負荷を与えますので、行わないで下さい。

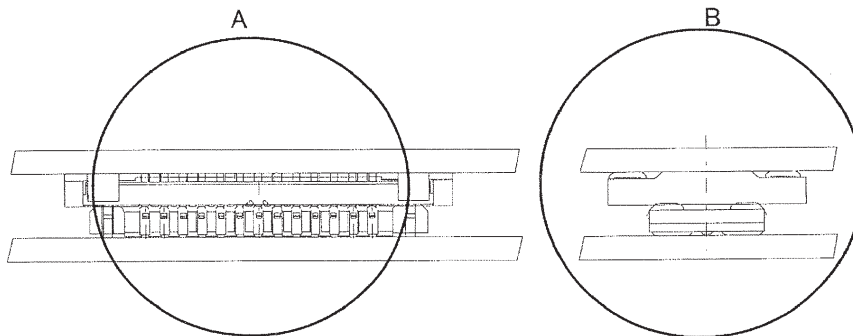

Please extract the connectors as being collimated.  
コネクタを抜く際は、平行に抜いてください。

SMK

2012.1.16 09:16:53  
10975

2016.12.21 16:44:50  
5204

# Recommended metal mask opening pattern 推奨メタルマスク開口寸法

Metal mask thickness=0.10mm

## SOCKET

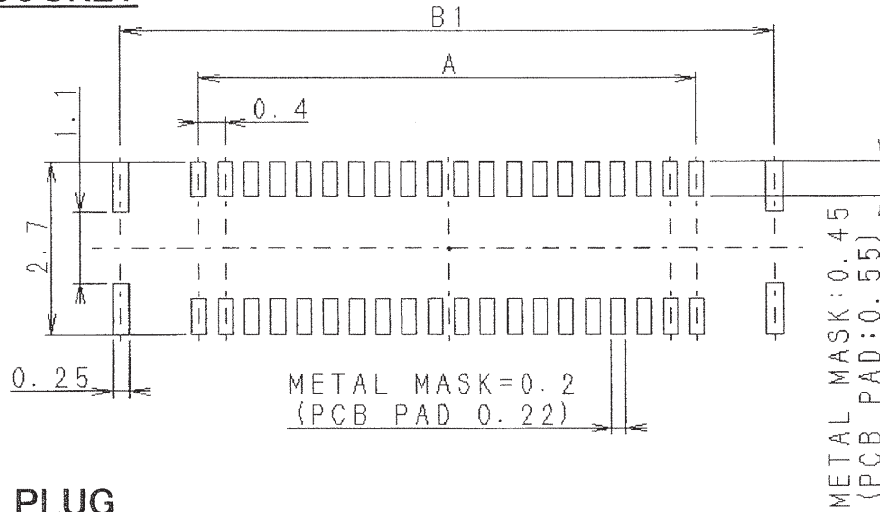

70	13.6	16	14.4
60	11.6	14	12.4
50	9.6	12.0	10.4
40	7.6	10.0	8.4
36	6.8	9.2	7.6
34	6.4	8.8	7.2
30	5.6	8.0	6.4
26	4.8	7.2	5.6
24	4.4	6.8	5.2
20	3.6	6.0	4.4
16	2.8	5.2	3.6
14	2.4	4.8	3.2
10	1.6	4.0	2.4
XX	A	B1	B2

## PLUG

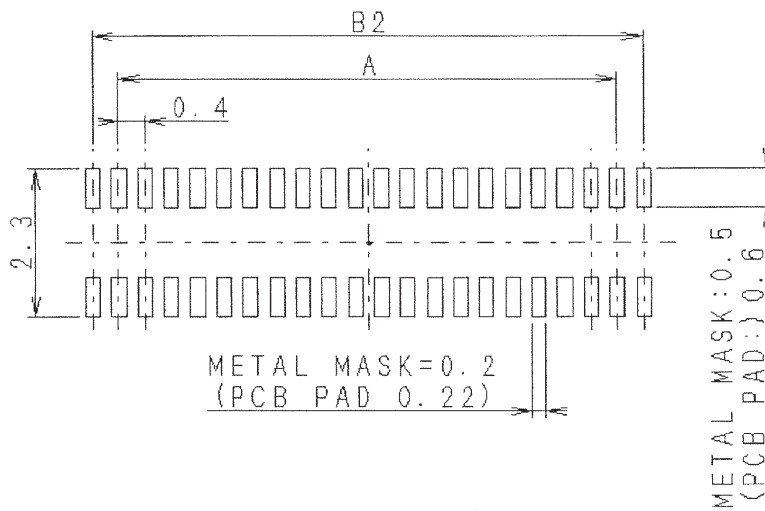

SMK

2012.1.16 09:16:53  
10975

2016.12.21 16:44:50  
5204

## X-ON Electronics

Largest Supplier of Electrical and Electronic Components

*Click to view similar products for [Board to Board & Mezzanine Connectors](#) category:*

*Click to view products by [SMK](#) manufacturer:*

Other Similar products are found below :

[589158040000018](#) [MDF7C-18P-2.54DSA\(55\)](#) [FCN-268F036-G/BD](#) [FCN-268M012-G/0D](#) [FCN-268M024-G/1D](#) [MIS-048-01-F-D-DP-K](#)  
[832-10-034-10-001000](#) [FX4C-80S-1.27DSA](#) [93696-330](#) [224393](#) [FCN-235D050-G/C](#) [210-93-314-41-105000](#) [MDF7-40DP-2.54DSA\(55\)](#)  
[MIT-114-03-F-D-K](#) [55323-1519](#) [026-6203-PDB](#) [027-6203-PDB](#) [069159702701000](#) [101A10019X](#) [105061100000861+](#) [55650-0588-C](#) [75140-](#)  
[7012](#) [87471-650](#) [YTW-30-07-H-Q-410-140](#) [YTT-112-01-H-Q](#) [063209](#) [10124054-515LF](#) [68685-603](#) [8-1616154-3](#) [MIS-019-01-F-D](#) [YTQ-](#)  
[12103HQ](#) [541371078](#) [IL-WX-10PB-HF-B-E1000E](#) [FCN-214J100-G/0](#) [FCN-230C068-E/S](#) [354184](#) [MIT-019-04-F-D-K](#) [P50-028-DDS-TG](#)  
[53309-2471](#) [54546-2071](#) [1586617-1](#) [504208-3010](#) [504208-5010](#) [504248-1010](#) [504248-1210](#) [504248-2010](#) [LST-115-07-S-D](#) [LST-105-07-G-](#)  
[D](#) [9159005551906](#) [6258](#)