

# - 规格书 -

产品型号： SEC-0111

产品名称： LED模组

Add : 江苏省无锡市新吴区弘毅路8号金帛座706室  
韩国京畿道富川市三鹊路22号富川科技园103-506栋  
TEL : +86-510-8591-9217  
E-mail : SMSWITCH@SIMAOKJ.COM  
Web : WWW.SIMAOKJ.CN



## ● Features:

1. Chip material: GaP/GaP
2. Emitted color : Bright Red
3. Lens Appearance : Red Diffused
4. Low power consumption.
5. High efficiency.
6. Versatile mounting on P.C. Board or panel.
7. Low current requirement.
8. 3mm diameter package.
9. This product don't contained restriction substance, compliance RoHS standard.

## ● Applications:

1. TV set
2. Monitor
3. Telephone
4. Computer
5. Circuit board

## ● Package dimensions:

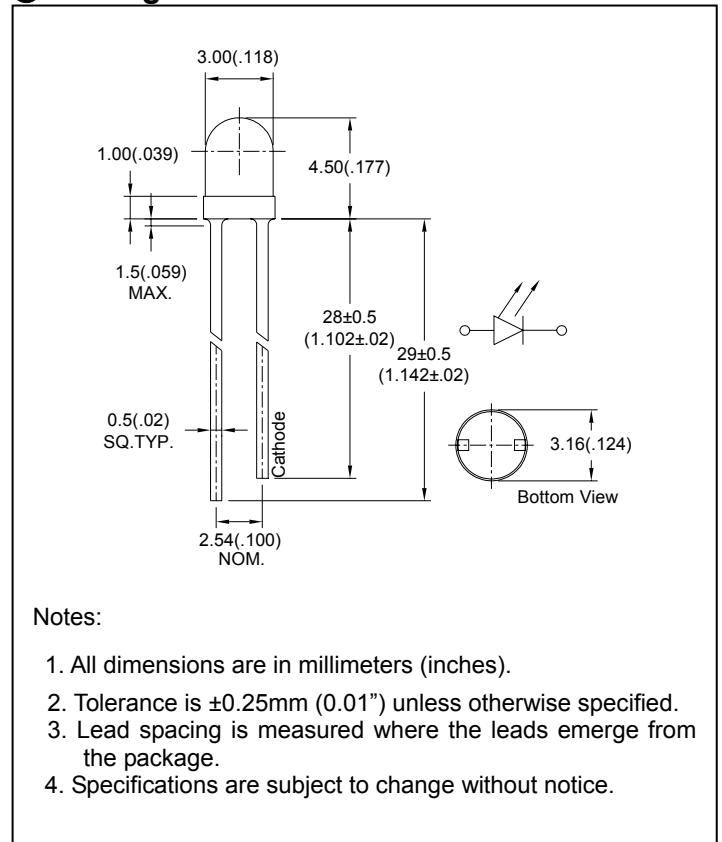

## ● Absolute Maximum Ratings( $T_a=25^\circ\text{C}$ )

Parameter	Symbol	Rating	Unit
Power Dissipation	$P_d$	40	mW
Forward Current	$I_F$	30	mA
Peak Forward Current* <sup>1</sup>	$I_{FP}$	50	mA
Reverse Voltage	$V_R$	5	V
Operating Temperature	$T_{opr}$	$-40^\circ\text{C} \sim 85^\circ\text{C}$	
Storage Temperature	$T_{stg}$	$-40^\circ\text{C} \sim 100^\circ\text{C}$	

\*<sup>1</sup>Condition for  $I_{FP}$  is pulse of 1/10 duty and 0.1msec width.

## ● Electrical and optical characteristics(Ta=25°C)

Parameter	Symbol	Condition	Min.	Typ.	Max.	Unit
Forward Voltage	$V_F$	$I_F=20\text{mA}$	-	2.3	2.6	V
Luminous Intensity	$I_v$	$I_F=20\text{mA}$	-	2.0	-	mcd
Reverse Current	$I_R$	$V_R=5\text{V}$	-	-	100	$\mu\text{A}$
Peak Wave Length	$\lambda_p$	$I_F=20\text{mA}$	-	700	-	nm
Dominant Wave Length	$\lambda_d$	$I_F=20\text{mA}$	-	650	-	nm
Spectral Line Half-width	$\Delta\lambda$	$I_F=20\text{mA}$	-	100	-	nm
Viewing Angle	$2\theta_{1/2}$	$I_F=20\text{mA}$	-	45	-	deg

## ● Typical Electro-Optical Characteristics Curves

Fig.1 Relative intensity vs. Wavelength

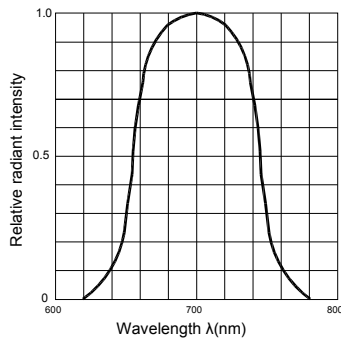

Fig.2 Forward current derating curve vs. Ambient temperature

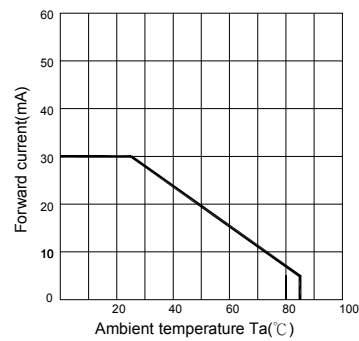

Fig.3 Forward current vs. Forward voltage

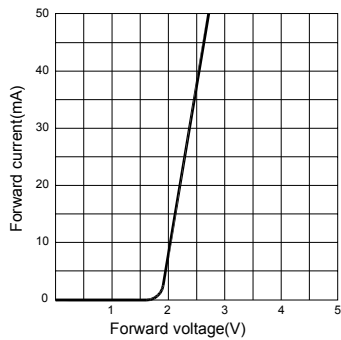

Fig.4 Relative luminous intensity vs. Ambient temperature

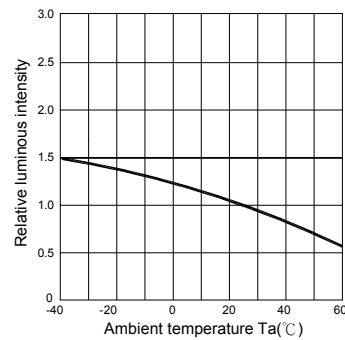

Fig.5 Relative luminous intensity vs. Forward current

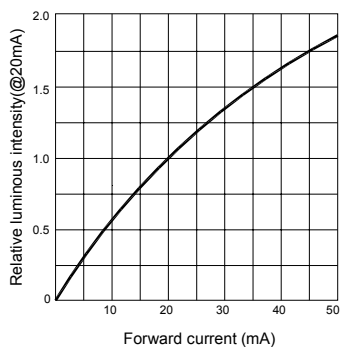
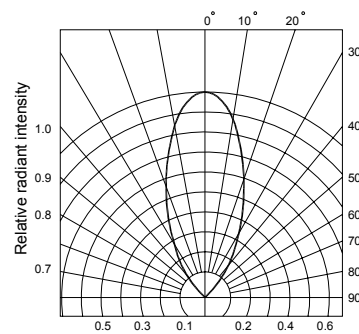

Fig.6 Radiation diagram



## ● Bin Limits

### 1. Intensity Bin Limits (At $I_F = 20\text{mA}$ )

Bin Code	Min. (mcd)	Max. (mcd)
C	0.7	1.0
D	1.0	1.6
E	1.6	2.4
F	2.4	3.7
G	3.7	5.5

Bin : x

↑  
Intensity bin code

NOTES: 1. Tolerance of measurement of luminous intensity.

: ±15%

## ● Reliability Test

Classification	Test Item	Reference Standard	Test Conditions	Result
Endurance Test	Operation Life	MIL-STD-750:1026 MIL-STD-883:1005 JIS-C-7021 :B-1	I <sub>F</sub> =20mA T <sub>a</sub> =+25°C±5°C Test time=1,000hrs	0/32
	High Temperature High Humidity Storage	MIL-STD-202:103B JIS-C-7021 :B-11	T <sub>a</sub> =+85°C±5°C RH=90%-95% Test time=240hrs	0/32
	High Temperature Storage	MIL-STD-883:1008 JIS-C-7021 :B-10	High T <sub>a</sub> =+85°C±5°C Test time=1,000hrs	0/32
	Low Temperature Storage	JIS-C-7021 :B-12	Low T <sub>a</sub> =-45°C±5°C Test time=1,000hrs	0/32
Environmental Test	Temperature Cycling	MIL-STD-202:107D MIL-STD-750:1051 MIL-STD-883:1010 JIS-C-7021 :A-4	T <sub>a</sub> : +85°C (30min) ~ +25°C (5min) ~ -45°C (30min) ~ +25°C (5min) Test Time : 70min/ctcle 10cycle	0/32
	Thermal Shock	MIL-STD-202:107D MIL-STD-750:1051 MIL-STD-883:1011	-45°C±5°C ~+85°C±5°C 20min 20min Test Time=10cycle	0/32
	Solder Resistance	MIL-STD-202:201A MIL-STD-750:2031 JIS-C-7021 :A-1	Preheating : 120°C, within 120-180 sec. Operation heating : 255°C±5°C within 5 sec. 260°C (Max)	0/32
	Solderability	MIL-STD-202F:208D MIL-STD-750D:2026 MIL-STD-883D:2003 JIS C 7021:A-2	T <sub>sol</sub> =230±5°C Dwell Time=5±1secs	0/32

## ● Judgment criteria of failure for the reliability

Measuring items	Symbol	Measuring conditions	Judgment criteria for failure
Forward voltage	V <sub>F</sub> (V)	I <sub>F</sub> =20mA	Over U <sup>1</sup> x1.2
Reverse current	I <sub>R</sub> (uA)	V <sub>R</sub> =5V	Over U <sup>1</sup> x2
Luminous intensity	I <sub>v</sub> ( mcd)	I <sub>F</sub> =20mA	Below S <sup>1</sup> X0.5

Note: 1. U means the upper limit of specified characteristics. S means initial value.

2. Measurement shall be taken between 2 hours and after the test pieces have been returned to normal ambient conditions after completion of each test.

## ● Dip Soldering

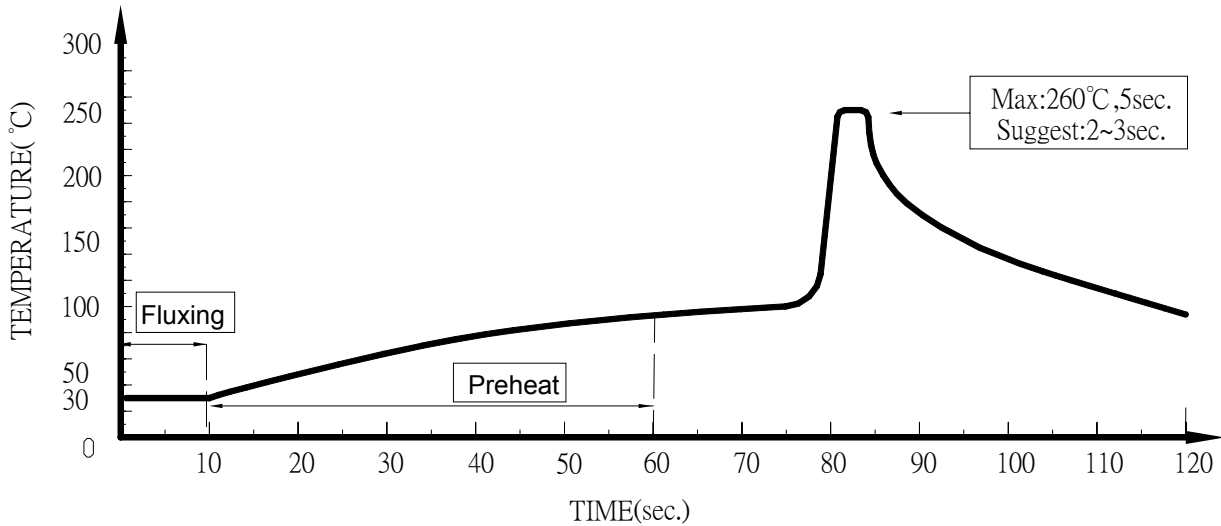

1. Please avoid any external stress applied to the lead-frames and epoxy while the LEDs are at high temperature, especially during soldering
2. DIP soldering and hand soldering should not be done more than one time.
3. After soldering, avoid the epoxy lens from mechanical shock or vibration until the LEDs are back to room temperature.
4. Avoid rapid cooling during temperature ramp-down process
5. Although the soldering condition is recommended above, soldering at the lowest possible temperature is feasible for the LEDs

## ● IRON Soldering

**300°C Within 3 sec., One time only.**

## X-ON Electronics

Largest Supplier of Electrical and Electronic Components

*Click to view similar products for [Standard LEDs - SMD category](#):*

*Click to view products by [SM Switch manufacturer](#):*

Other Similar products are found below :

[LTST-C190KYKT](#) [LTST-C19GD2WT](#) [LTW-170ZDC](#) [LTW-M140SZS40](#) [LTW-M140ZVS](#) [598-8110-100F](#) [598-8610-202F](#) [91-21SUBCS400-A6TR7](#) [AAAF5060QBFSEEZGS](#) [APT1608QGW](#) [99-213/R6C-AR2T1B/2C](#) [SML-LX0606SISUGC/A](#) [SML-LXR851SIUPGUBC](#) [LT1ED53A](#) [APFA3010SURKCGKQBDC](#) [APHK1608VGCA](#) [APT2012QGW](#) [LTST-008BGEW](#) [LTW-010DCG](#) [LTW-020ZDCG](#) [LTW-21TS5](#) [LTW-220DS5](#) [598-8330-117F](#) [65-21SYGC/S530-E3/TR8](#) [CMDA20AYAA7D1S](#) [95-21SURCS530-A3TR10](#) [598-8070-100F](#) [598-8140-100F](#) [598-8610-200F](#) [SML-LXR851SGSIC-TR](#) [SML-512PWT86A](#) [EASV3015RGYA0](#) [95-21UYC-S530-A5-TR7](#) [LTST-C190KFKT-5A](#) [LTST-C194TBKT-5A](#) [CLX6E-FKC-CH1M1D1BB7C3D3](#) [SML-LXL0805USBC-TR](#) [SML-LX2835SYSUGCTR](#) [LTW-M670ZVS-M5](#) [APA2106ZGC/G](#) [CLMXB-FKA-CbcfghjnpACBB79463](#) [KPTD-2012LVVBC-D](#) [VFA1101W-5AY3B2-TR](#) [LCB P473-P2R2-3J7L-1-Z](#) [91-21VGC/S556/S68/TR10/S370](#) [LW A67C-S2U1-FK0KM0](#) [LW A673-P1S1-FK0PM0](#) [BL-HE1G033B-TRB](#) [5988B90107F](#) [EL-19-21SURC/S530-A6](#)