

# - 规格书 -

产品型号： SMXP系列

产品名称： 拨码开关

Add : 江苏省无锡市新吴区弘毅路8号金帛座706室  
韩国京畿道富川市三鹊路22号富川科技园103-506栋  
TEL : +86-510-8591-9217  
E-mail : SMSWITCH@SIMAOKJ.COM  
Web : WWW.SIMAOKJ.CN

## ► Type selection table description.

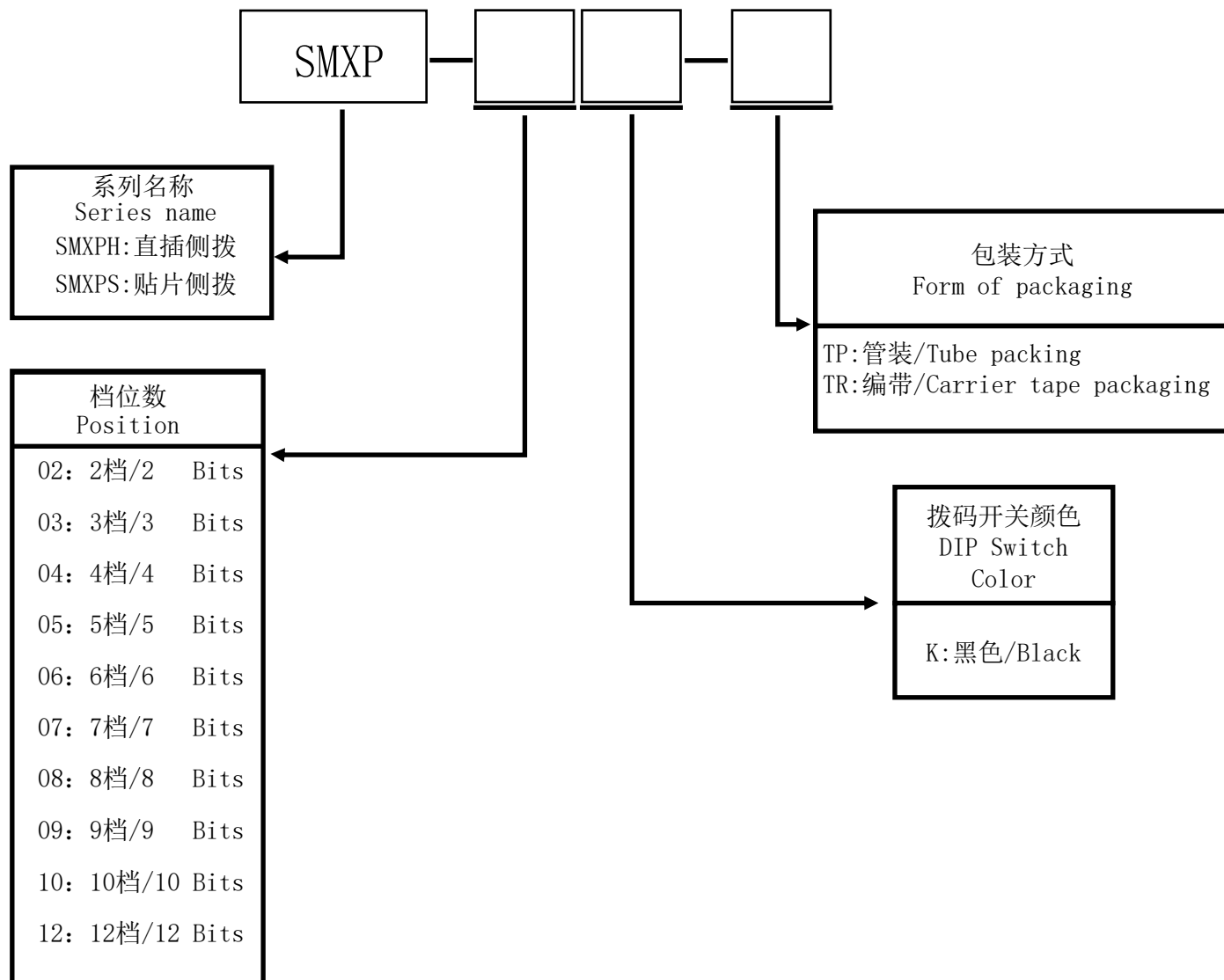

- Please check the type of switch according to the type specification.

## ➤ Outline Dimensions

### ◆ SMXPH-□-□-□

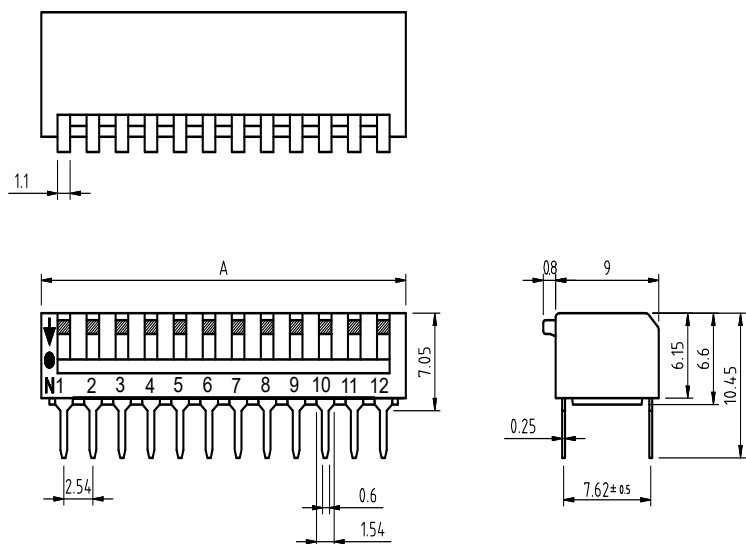

#### ◆ SCHEMATIC

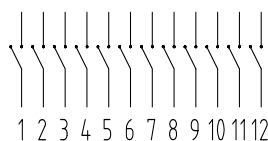

#### ◆ P. C. B LAYOUT

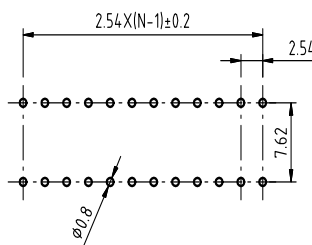

Poles(N)	A (mm)
02	6.48
03	9.02
04	11.56
05	14.10
06	16.64
07	19.18
08	21.72
09	24.26
10	26.80
12	31.88

### ◆ SMXPS-□-□-□

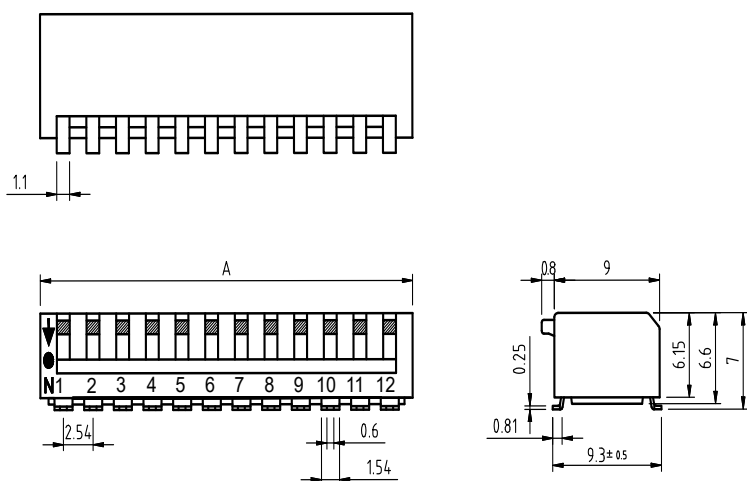

#### ◆ SCHEMATIC

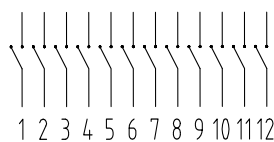

#### ◆ P. C. B LAYOUT

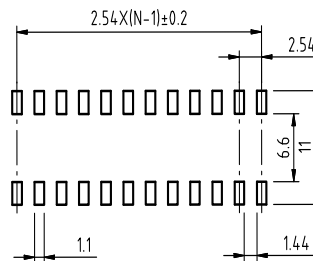

Poles(N)	A (mm)
02	6.48
03	9.02
04	11.56
05	14.10
06	16.64
07	19.18
08	21.72
09	24.26
10	26.80
12	31.88

## ➤ Material Description

拨柄/ACTUATOR	PBT UL 94V-0
外壳/COVER	PBT UL 94V-0
基座/BASE	PBT UL 94V-0
接触端子/CONTACT&TERMINAL	PHOSPHOR BRONZE GOLD PLATING
填充胶/TAPE	EPOXY RESIN

## ➤ Characteristics

工作温度/Operation Temperature	-30°C to +85°C
储存温度/Storage Temperature	-40°C to +85°C
电气寿命/ Electrical Life	1000 cycles
机械寿命/ Mechanical Life	3000 cycles
动作力 / Operation Force	1000gf Max
耐压 / Dielectric Strength	300VDC/1 minute
绝缘电阻/Insulation Resistance	100MΩ Min at 100VDC
接触电阻/Contact Resistance	Initia : 50m Ω Max After life: 100m Ω Max
额定电流/Rated Current	Switching : 25mA at 24VDC Non-Switching: 100mA at 50VDC

## ➤ Welding Specification

波焊 /Wave Welding	$240 \pm 5 \text{ } ^\circ\text{C}$ , 3~5sec (Peak temperature) (Please refer to the profile below)
手工焊锡/ Manual Soldering	320°C 2 sec

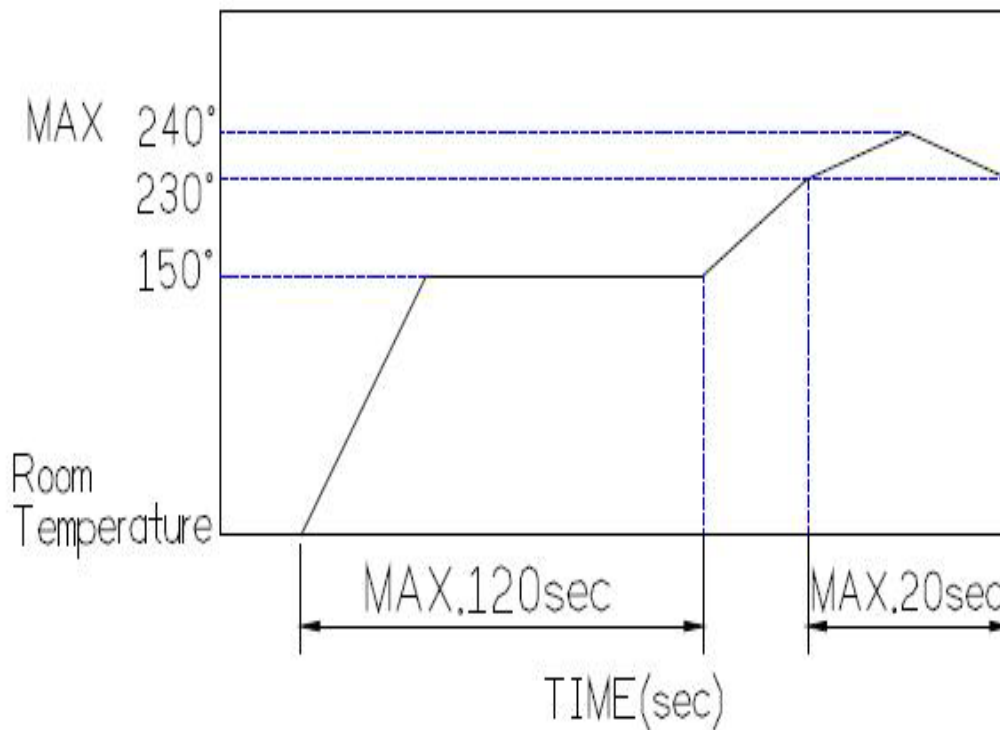

\*Above refers to the temperature of copper foil on PCB.

PCB temperature and switch surface temperature have big difference, namely PCB material. Small size, thickness, etc. are important, so please be careful not to exceed 240°C on the switch surface.

\*上述提到的情况，是指 PCB 上铜箔的温度。

有一些情况会有 PCB 的温度和开关表面的温度会有很大的不同，这和 PCB 的材质，大小，厚度等有很大的关系。因此要小心不要让开关表面的温度超过 240°C。

\*Points to Note:

Auxiliary flux on PCB board, do not stick to switch body.

\*处理时注意事项:

在 P.C.B 板面上助焊剂，不要沾到开关本身。

## X-ON Electronics

Largest Supplier of Electrical and Electronic Components

*Click to view similar products for [DIP Switches/SIP Switches](#) category:*

*Click to view products by [SM Switch](#) manufacturer:*

Other Similar products are found below :

[79B10T](#) [8136-475G4T](#) [G7G-1A2-CB-DC12](#) [DRR60016](#) [DRS4016](#) [1825444-1](#) [200183](#) [206002](#) [219-6LPSTRF](#) [25.350.0653.0](#)  
[SDA10H1BDA](#) [97R06ST](#) [A2C-2A5](#) [1825058-4](#) [1825444-7](#) [ADE08SA04](#) [ADE12S04](#) [192960010](#) [206005RAS](#) [206007](#) [2-1825058-8](#)  
[25.352.0353.0](#) [CXDRIVEV2X](#) [LA2-002-DC24](#) [DSR02T](#) [E2FMX2D1M1TGJ03M](#) [NDI10H](#) [219-9MSTP](#) [EPM02FV](#) [206010RAST](#) [219-](#)  
[5LPSTJRF](#) [76SB05](#) [TD06H0SK1](#) [Z7.255.9027.0](#) [1-1825058-3](#) [1825428-4](#) [219-10LPSTF](#) [E3ZG6111D03M](#) [G4D212PUSTV2DC5](#)  
[EPG301BT06](#) [1-1825058-6](#) [E3TSL23M5J03M](#) [Y5795](#) [7R0060](#) [HARW0001](#) [ADE07S04](#) [432220096](#) [206005](#) [206006](#) [206010](#)