

2-Electrode Gas Discharge Tube (GDT)

UN2E5 Series

Description

Gas discharge Tubes (GDT) are classical components for protecting the installations of the telecommunications. It is essential that IT and telecommunications systems -with their high-grade but sensitive electronic circuits - be protected by arresters. They are thus fitted at the input of the power supply system together with varistors and at the connection points to telecommunication lines. They have become equally indispensable for protecting base stations in mobile telephone systems as well as extensive cable television (CATV) networks with their repeaters and distribution systems.

These protective components are also indispensable in other sectors, In AC power transmission systems, they are often used with current-limiting varistors, In customer premises equipment such as DSL modems, WLAN routers, TV sets and cable modems In air-conditioning equipment, the integral black-box concept offers graduated protection by combining arresters with varistors, PTC, diodes and inductor.

Features

- u Non-Radioactive
- u RoHS compliant
- u Low insertion loss
- u Excellent response to fast rising transients
- u Ultra low capacitance
- u 5KA surge capability tested with 8/20µs pulse as defined by IEC 61000-4-5

Applications

- u Communication equipment
- u CATV equipment
- u Test equipment
- u Data lines
- u Power supplies
- u Telecom SLIC protection
- u Broadband equipment
- u ADSL equipment, including ADSL2+
- u XDSL equipment
- u Satellite and CATV equipment
- u Consumer electronics

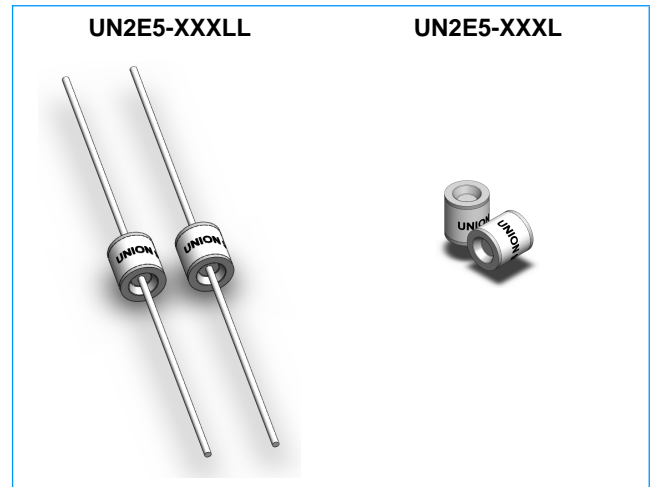

Schematic Symbol

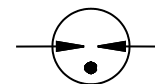

Agency Approvals

AGENCY	AGENCY FILE NUMBER
	E341061

Product Characteristics

Materials	Nickel-plated with Tinplated wires	
Product Marking	UNION XXXL XXX -Nominal voltage L -5KA	
Glow to Arc Transition Current	< 0.5 Amps	
Glow Voltage	~60 Volts	
Storage and Operational Temperature	-40 to +90°C	
Climatic category (IEC 60068-1)	40/90/21	
Weight	UN2E5-XXXLL	~1.0g
	UN2E5-XXXL	~0.85g

2-Electrode Gas Discharge Tube (GDT)

UN2E5 Series

Dimensions (Unit: mm)

Axial Leaded Devices (UN2E5-XXXLL)

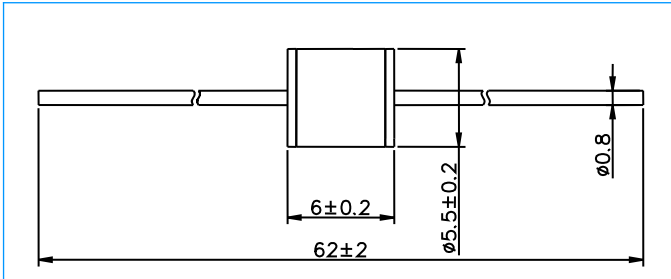

Without wire Devices (UN2E5-XXXL)

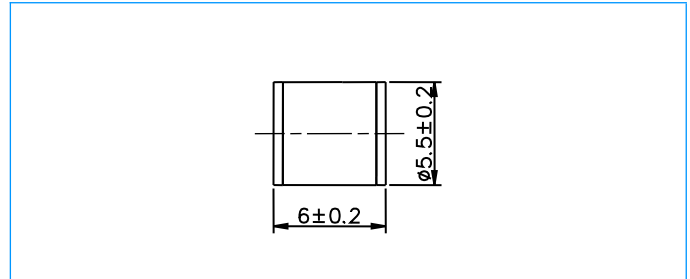

Electrical Characteristics

Part Number	Marking	DC Spark-over Voltage	Maximum Impulse Spark-over Voltage		Minimum Insulation Resistance	Maximum Capacitance	Arc Voltage	Service Life			
								Nominal Impulse Discharge Current	Max Impulse Discharge Current	Nominal Alternating Discharge Current	Impulse Life
UN2E5-75LL UN2E5-75L	75L	75V±20%	<500V	<600V	1 GΩ (at 25V)	<1.0pF	~15V	5KA	10KA	5A	100A
UN2E5-90LL UN2E5-90L	90L	90V±20%	<500V	<600V	1 GΩ (at 50V)	<1.0pF	~15V	5KA	10KA	5A	100A
UN2E5-150LL UN2E5-150L	150L	150V±20%	<500V	<600V	1 GΩ (at 50V)	<1.0pF	~20V	5KA	10KA	5A	100A
UN2E5-230LL UN2E5-230L	230L	230V±20%	<600V	<700V	1 GΩ (at 100V)	<1.0pF	~20V	5KA	10KA	5A	100A
UN2E5-250LL UN2E5-250L	250L	250V±20%	<700V	<800V	1 GΩ (at 100V)	<1.0pF	~20V	5KA	10KA	5A	100A
UN2E5-300LL UN2E5-300L	300L	300V±20%	<800V	<900V	1 GΩ (at 100V)	<1.0pF	~20V	5KA	10KA	5A	100A
UN2E5-350LL UN2E5-350L	350L	350V±20%	<800V	<900V	1 GΩ (at 100V)	<1.0pF	~20V	5KA	10KA	5A	100A
UN2E5-420LL UN2E5-420L	420L	420V±20%	<900V	<1000V	1 GΩ (at 100V)	<1.0pF	~20V	5KA	10KA	5A	100A
UN2E5-470LL UN2E5-470L	470L	470V±20%	<900V	<1000V	1 GΩ (at 100V)	<1.0pF	~20V	5KA	10KA	5A	100A
UN2E5-600LL UN2E5-600L	600L	600V±20%	<1100V	<1200V	1 GΩ (at 100V)	<1.0pF	~20V	5KA	10KA	5A	100A
UN2E5-800LL UN2E5-800L	800L	800V±20%	<1200V	<1400V	1 GΩ (at 100V)	<1.0pF	~20V	5KA	10KA	5A	100A

Notes:

- 1). Terms in accordance with ITU-T K.12 and GB/T 9043-2008
- 2). At delivery AQL 0.65 level II, DIN ISO 2859

2-Electrode Gas Discharge Tube (GDT)

UN2E5 Series

Electrical Rating

Item	Test Condition / Description	Requirement
DC Spark-over Voltage	The voltage is measured with a slowly rate of rise $dv / dt=100V/s$	To meet the specified value
Impulse Spark-over Voltage	The maximum impulse spark-over voltage is measured with a rise time of $dv / dt=100V/\mu s$ or $1KV/\mu s$	
Insulation Resistance	The resistance of gas tube shall be measured each terminal each other terminal, please see above spec.	
Capacitance	The capacitance of gas tube shall be measured each terminal to each other terminal. Test frequency :1MHz	
Nominal Impulse Discharge Current	<p>The maximum current applying a waveform of $8/20\mu s$ that can be applied across the terminals of the gas tube. One hour after the test is completed, re-testing of the DC spark-over voltage does not exceed $\pm 30\%$ of the nominal DC spark-over voltage. Dwell time between pulses is 3 minutes.</p>	
Nominal Alternating Discharge Current	Rated RMS value of AC current at 50Hz, 1 sec. 10 times. Intervals: 3min. The DC spark-over voltage does not exceed $\pm 30\%$ of the nominal DC spark-over voltage. $IR > 10^8 ohms$.	

Recommended soldering profile

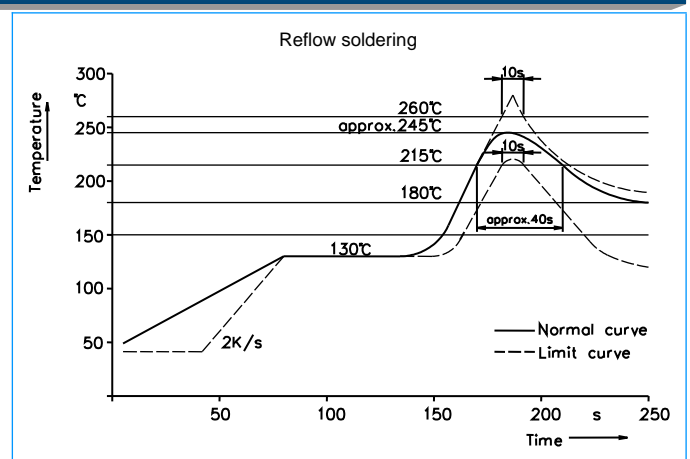
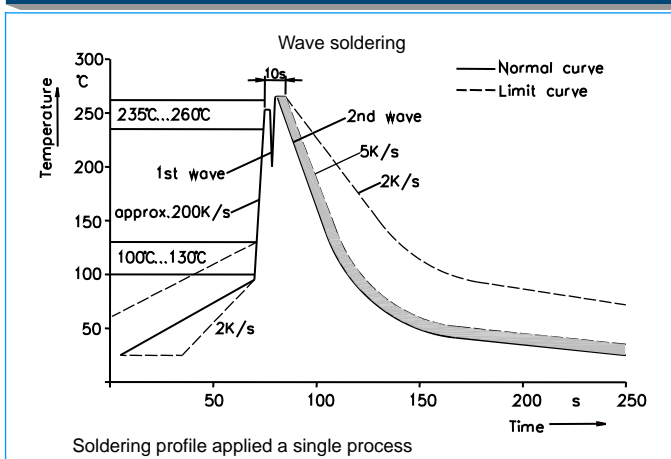

Soldering Parameters - Hand Soldering

Solder Iron Temperature: 350°C $\pm 5^\circ C$
 Heating Time: 5 seconds max.

2-Electrode Gas Discharge Tube (GDT)

UN2E5 Series

Part Numbering

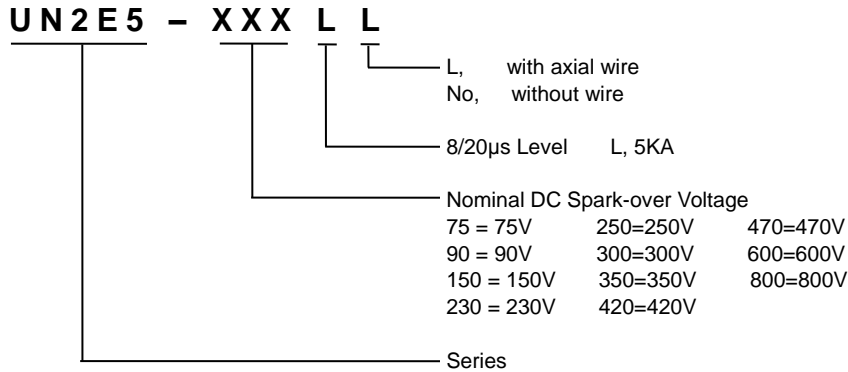

Packaging Information Unit: mm

Part Number	Description	Quantity
UN2E5-XXXLL	100PCS per Tray, 10 Trays / Inner Carton	1000
UN2E5-XXXL	100PCS per Tray, 10 Trays / Inner Carton	1000

Tray used in UN2E5-XXXLL

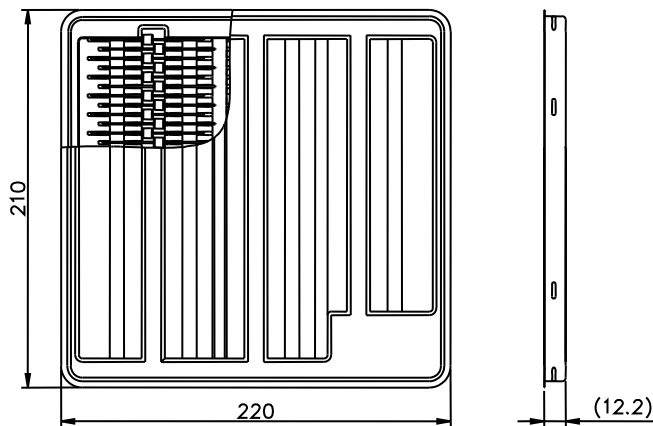

Tray used in UN2E5-XXXL

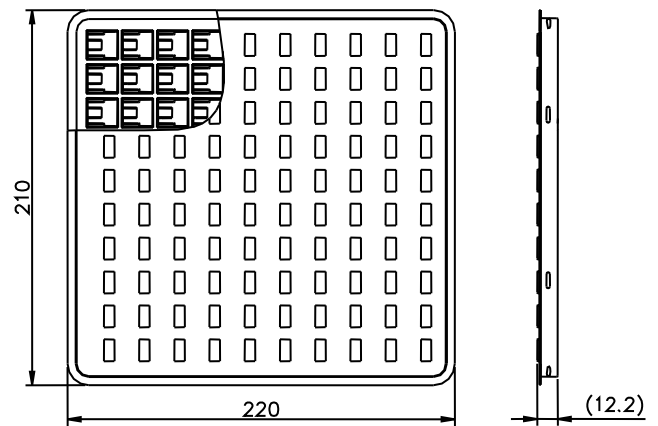

Cautions and warnings

- ⚠ Gas discharge tubes (GDT) must not be operated directly in power supply networks.
- ⚠ Gas discharge tubes (GDT) may become hot in case of longer periods of current stress (danger of burning).
- ⚠ Gas discharge tubes (GDT) may be used only within their specified values. In the event of overload, the head contacts may fail or the component may be destroyed.
- ⚠ Damaged Gas discharge tubes (GDT) must not be re-used.

X-ON Electronics

Largest Supplier of Electrical and Electronic Components

Click to view similar products for [Gas Discharge Tubes - GDTs / Gas Plasma Arrestors](#) category:

Click to view products by [SOCAY](#) manufacturer:

Other Similar products are found below :

[M51-A90X](#) [PMT1023004](#) [PMT1040004](#) [CG2800](#) [GTCR37-231M-R10](#) [WPGT-2N145B6L](#) [WPGT-2N230B6L](#) [WPGT-2N470B6L](#) [WPGT-2RM230A6L](#) [WPGT-2RM350A6L](#) [WPGT-2RM70A6L](#) [WPGT-2RM90A6L](#) [WPGT-2S145](#) [WPGT-2S350](#) [WPGT-2S470](#) [WPGT-3R350CF](#) [WPGT-3R350G1](#) [WPGT-3R90G1](#) [WPGT-3R75G1](#) [WPGT-3R470G1](#) [WPGT-3R250C](#) [WPGT-3R230G1](#) [WPGT-2S230](#) [WPGT-2RM145A6L](#) [WPGT-2R1000B8L](#) [WPGT-2N70B6L](#) [WPGT-2N350B6L](#) [WPGT-2N230B6L1](#) [CG2145](#) [T61-C350X](#) [9071.99.0547 \(73_Z-0-0-547\)](#) [B88069X6940B152](#) [RF1219-000](#) [A9L16618](#) [RF2339-000](#) [9071.99.0052\(73_Z-0-0-52\)](#) [9071.99.0054](#) [CG32.7L](#) [CG6400SM](#) [CG6470SM](#) [CG7250MS](#) [CG7400MS](#) [SPBT12-280/1](#) [SPCT2-280/3](#) [SPCT2-280/4](#) [T2 20KA 4P](#) [2003-09-SM-RPLF](#) [2026-07-A1](#) [2026-25-C3](#) [2039-80-BLF](#)