

**Operation:** 4DIP+SMT5PIN Micro USB/卧式&插板 钢质加强舌片



**LTEM NO.:** MC-142P

(L8.00mm × W2.90mm × H6.70mm CONNECTORS)



## Technical parameter

PROJECT	LEVEL	A[better product]		B[average product]	
<b>Electrical Properties</b>	Contact Rating	1.0A, 24V DC			
	Initial Contact Resistance	30mΩ max.		50mΩ max.	
	Insulation Resistance	100MΩ min.500V DC	Skew/PD:	100MΩ min.300V DC	
	Withstand Voltage	500V AC for 1 minute		350 V AC for 1 minut	
<b>Durable Performance</b>	There No Load	8,000 Cycles		6,000 Cycles	
	Rated Load	6,500 Cycles		5,000 Cycles	
	Storage temp.	-25℃~+75℃(Operating Temp: )			

表面贴片+DIP

側向導入 LATERAL

精密部品 NICETY

可靠 STABILIZE

適合環保 RoHS

Unit:mm

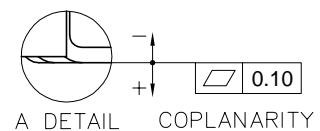
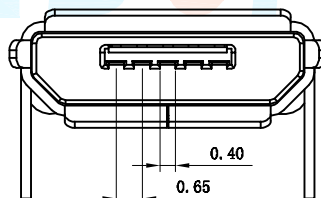
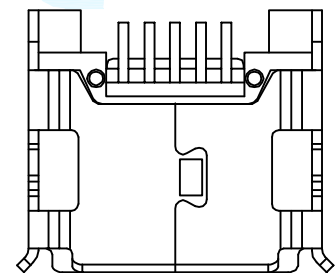
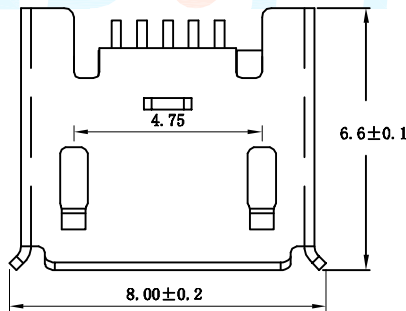
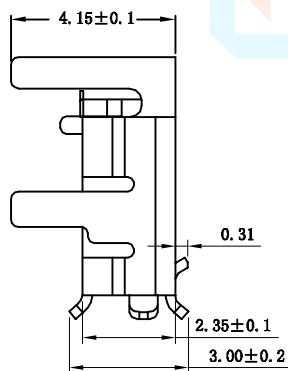
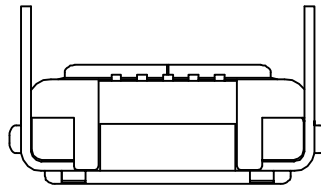
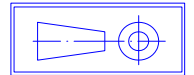

## Operating Force

Inward  
Exiting

5. 0N (500gf) ~8. 0N

6. 0N [(800gf) ~8. 5N

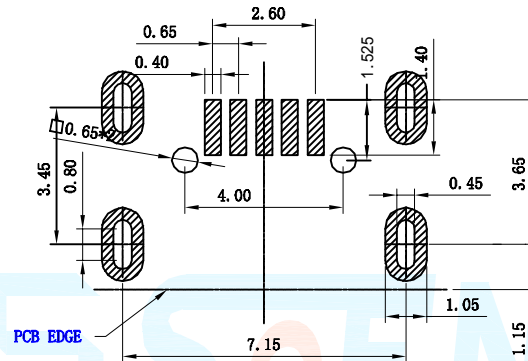

## Pin Definition

## Material declaration

No.	NAME	Type	Description
①	SHELL	1	Stainless Steel,(Gold Flash)
②	HOUSING	1	THERMOPLASTIC(glass fiber filled)BK
③	CONTACT	5	BRASS(t=0.12mm)
④	METAL COVER	1	STAINLESS STEEL(t=0.25mm)



本品不屬於危害性廢棄物,須丟棄時可以委託  
回收商予以回收再生處理。  
Products do not belong to •

## 注記 NOTICE

1. 碩方公司擁有最終解釋權; The company reserves the right of final interpretation;
2. 文件禁止外洩、轉載; Leaked and reproduced prohibited;
3. 未經授權修改無效。Modify is invalid.

運送時本產品不要直接與水、酸鹼性化學物質  
接觸,或放置於含有以上氣體環境中,並且需要  
注意會有滑落、側翻的危險發生; 運輸過程中  
不能有碰撞或者擠壓,須保證溫度與濕度適中  
[常溫 25℃,濕度在 50℃以內],不可導致材料變  
形或氧化。

## X-ON Electronics

Largest Supplier of Electrical and Electronic Components

*Click to view similar products for [USB Connectors](#) category:*

*Click to view products by [SOFNG](#) manufacturer:*

Other Similar products are found below :

[950](#) [A-USB B-TOP-C](#) [MUSBA511N5](#) [MUSBC111M5](#) [MUSBD11135](#) [17-200721](#) [217450-1](#) [KMBVX-TH-5S-B30](#) [896-30-004-00-000000](#)  
[KUSBX-AS2N-W](#) [KUSBX-SMT2AP1S-W30](#) [935](#) [957](#) [30-498-6](#) [SK-60A-2](#) [1734082-1](#) [CIR06R-18-12S-F80-T12-26](#) [CIR08F-20](#) [30-1574](#)  
[30-470](#) [30-489](#) [30-541](#) [MAB 5 S](#) [A-USB A-2P-C](#) [MIKROE-1451](#) [USBFTV2PEM2G](#) [USBFTVC6ZN](#) [USBFTVSCCG](#) [4689-1](#) [1-1734084-2](#)  
[MUSBC11135](#) [CIR08F-20-27P-F80-VO](#) [USBF21ZNSCC](#) [USBBFTV6ZC](#) [10135326-001LF](#) [M9177/3-1](#) [USB-A-S-F-B-VT](#) [4198](#) [1310-1018-](#)  
[05](#) [690-024-633-031](#) [UB-20PMFP-LC7001](#) [UA-20BMFA-SL8001](#) [17-200011](#) [USBFTVC7ZC](#) [UB-20AFMM-LL7A01](#) [USBFTVC2MN](#)  
[CAP-WCCMLPB1](#) [CAP-WCCMLPC1](#) [1310-1031-01](#) [2041386-1](#)