

MCR Hardwired Series – Power Line Conditioning with Voltage Regulation

The MCR Hardwired Series provides excellent noise filtering and surge suppression to protect connected equipment from damage, degradation or misoperation. Combined with the excellent voltage regulation inherent to Sola/Hevi-Duty's patented ferroresonant design, the MCR can increase the actual Mean Time Before Failure (MTBF) of protected equipment. The MCR is a perfect choice where dirty power, caused by impulses, swell, sags, brownouts and waveform distortion can lead to costly downtime because of damaged equipment.



Related Products

- On-line UPS (S4K Industrial)
- Surge Suppression
- Three Phase Power Conditioners

Selection Tables: Single Phase

Group 2 – MCR Series, 60 Hz Only



VA	Catalog Number	Voltage Input	Voltage Output	Height (inch)	Width (inch)	Depth (inch)	Ship Weight (lbs)	Design Style	Elec Conn
120	63-23-112-4	120, 208, 240, 480	120	9	4	5	15	1	D
250	63-23-125-4	120, 208, 240, 480	120	10	6	8	27	1	D
500	63-23-150-8	120, 208, 240, 480	120, 208, 240	13	9	7	37	1	E
750	63-23-175-8	120, 208, 240, 480	120, 208, 240	14	9	7	52	1	E
1000*	63-23-210-8	120, 208, 240, 480	120, 208, 240	17	9	7	62	1	E
1500*	63-23-215-8	120, 208, 240, 480	120, 208, 240	17	13	9	95	1	E
2000*	63-23-220-8	120, 208, 240, 480	120, 208, 240	18	13	9	109	1	E
3000*	63-23-230-8	120, 208, 240, 480	120, 208, 240	19	13	9	142	1	E
5000*	63-23-250-8	120, 208, 240, 480	120, 208, 240	28	13	9	222	1	E
7500**	63-28-275-8	208, 240, 480	120, 208, 240	27	26	9	362	2	F
10000**	63-28-310-8	208, 240, 480	120, 208, 240	28	26	9	446	2	F
15000**	63-28-315-8	208, 240, 480	120, 208, 240	28	38	10	710	3	F

* Canadian option: cULus certified units must be ordered by changing "-8" (UL only) to "-C8".

** UL Listed Only. Use Group 3 for cULus.

Features

- $\pm 3\%$ output voltage regulation
- Noise attenuation
 - 120 dB common mode
 - 60 dB transverse mode
- Surge suppression tested to ANSI/IEEE C62.41 Class A & B Waveform:
 - <10 V let through typical
- Acts as a step-up or step-down transformer
- Harmonic filtering
- Hardwired
- Galvanic isolation provides exceptional circuit protection.
- 25 year typical MTBF
- No maintenance required

Applications

- Industrial automation and control equipment PLCs
- Machine tools
- Computer loads and electronic equipment
- Robotics
- Semiconductor fabrication equipment

Selection Tables: Single Phase

Group 3 – MCR Series, 60 Hz Only



VA	Catalog Number	Voltage Input	Voltage Output	Height (inch)	Width (inch)	Depth (inch)	Ship weight (lbs)	Design Style	Elec Conn
500	63-31-150-8	600	120, 208, 240	13	9	7	38	1	B
1000	63-32-210-8	600	120, 208, 240	17	9	7	62	1	B
2000	63-32-220-8	600	120, 208, 240	18	13	10	109	1	B
3000	63-32-230-8	600	120, 208, 240	19	13	10	142	1	B
5000	63-29-250-8	208, 240, 480, 600	120, 208, 240	28	13	10	221	1	A
7500	63-29-275-8	208, 240, 480, 600	120, 208, 240	27	25	10	360	2	A
10000	63-29-310-8	208, 240, 480, 600	120, 208, 240	28	25	10	441	2	A
15000	63-29-315-8	208, 240, 480, 600	120, 208, 240	28	38	10	706	3	A

Group 4 – MCR Series, 50 Hz Only (±5% output voltage regulation)



VA	Catalog Number	Voltage Input	Voltage Output	Height (inch)	Width (inch)	Depth (inch)	Ship weight (lbs)	Design Style	Elec Conn
120	63-23-612-8	110, 120, 220, 240, 380, 415	110, 120, 220, 240	9	6	8	24	1	C
250	63-23-625-8	110, 120, 220, 240, 380, 415	110, 120, 220, 240	11	6	8	27	1	C
500	63-23-650-8	110, 120, 220, 240, 380, 415	110, 120, 220, 240	13	9	7	40	1	C
1000	63-23-710-8	110, 120, 220, 240, 380, 415	110, 120, 220, 240	18	9	7	64	1	C
2000	63-23-720-8	110, 120, 220, 240, 380, 415	110, 120, 220, 240	18	13	10	113	1	C
3000	63-23-730-8	110, 120, 220, 240, 380, 415	110, 120, 220, 240	27	13	10	162	1	C
5000	63-23-750-8	110, 120, 220, 240, 380, 415	110, 120, 220, 240	30	13	10	266	1	C
7500	63-28-775-8	220, 240, 380, 415	110, 120, 220, 240	28	26	10	393	2	C1
10000	63-28-810-8	220, 240, 380, 415	110, 120, 220, 240	30	26	10	490	2	C2
15000	63-28-815-8	220, 240, 380, 415	110, 120, 220, 240	30	38	10	776	3	C2

Specifications

Parameter	Condition	Value
Input		
Voltage	Continuous at full load (lower input voltage possible at lighter load)	+10% to -20% of nominal
	For temporary surge or sags	+20% to -35% of nominal
Current¹	at Full Load & 80% of nominal input voltage	$I_{in} \cong (VA/.89)/(V_{in} \times 80\%)$
Frequency	See Operating Characteristics section for details.	50 Hz or 60 Hz depending on model
Output		
Line Regulation	$V_{in} >80\%$ and $<110\%$ of nominal	± 5% for 50 Hz units, ± 3% for 60 Hz units
Overload Protection	At Nominal Input Voltage	Current limited at 1.65 times rated current
Output Harmonic Distortion	At full load within input range	3% total RMS content
Noise Attenuation	-Common Mode	120 dB
	-Transverse Mode	60 dB
General		
Efficiency	At Full Load	Up to 92%
Storage Temperature	Humidity <95% non-condensing	-20° to +85°C
Operating Temperature	Humidity <95% non-condensing	-20° to 50°C
Audible Noise	Full Resistive Noise	35 dBA to 65 dBA
Approvals	60 Hz Models	UL1012, CSA evaluated by UL
	50 Hz Models	CE (EMC & LVD)
Warranty	See General Information section for details	10 + 2 Years
Notes:		
1 - Consult user manual for fuse sizing.		

Electrical Connections

A

Primary Voltage	Interconnect	Connect Lines To
208	H1 to H4 H2 to H5	H1 & H5
240	H1 to H4 H3 to H6	H1 & H6
480	H3 to H4	H1 & H6
600	H3 to H4	H1 & H7
Secondary Voltage	Interconnect	Connect Lines To
120		X1 & X2 or X3 & X2
208		X4 & X5
240		X1 & X3

MCR 60 Hz 5000–15000 VA

B

475-650 V

Primary Voltage	Interconnect	Connect Lines To
600		H1 & H2
Secondary Voltage	Interconnect	Connect Lines To
120		X1 & X2 or X3 & X2
208		X4 & X5
240		X1 & X3

MCR 60 Hz 500–3000 VA

C

Primary Voltage	Interconnect	Connect Lines To
110-120	H1 to H3 H2 to H4	H1 & H4
220-240	H2 to H3	H1 & H4
380-415	H2 to H3	H1 & H5
Secondary Voltage	Interconnect	Connect Lines To
110		X1 & X2 or X3 & X2
120		X4 & X2 or X5 & X2
220		X1 & X3
240		X4 & X5

MCR 50 Hz 120–5000 VA

C1

Primary Voltage	Interconnect	Connect Lines To
220-240	H1 to H3 H2 to H5	H1 & H5
380-415	H2 to H3	H1 & H4
Secondary Voltage	Interconnect	Connect Lines To
110		X1 & X2 or X2 & X3
120		X4 & X2 or X5 & X2
220		X1 & X3
240		X4 & X5

MCR 50 Hz 7500 VA

C2

Primary Voltage	Interconnect	Connect Lines To
220-240	H2 to H3	H1 & H4
380-415	H2 to H3	H1 & H5
Secondary Voltage	Interconnect	Connect Lines To
110		X1 & X2 or X3 & X2
120		X4 & X2 or X5 & X2
220		X1 & X3
240		X4 & X5

MCR 50 Hz 10000–15000 VA

D

H5 380-520V

H4 190-260V

H3 175-235V

H2 95-130V

H1 Common

Primary Voltage	Interconnect	Connect Lines To
120		H1 & H2
208		H1 & H3
240		H1 & H4
480		H1 & H5
Secondary Voltage	Interconnect	Connect Lines To
120		X1 & X2

MCR 60 Hz 120–250 VA

Electrical Connections

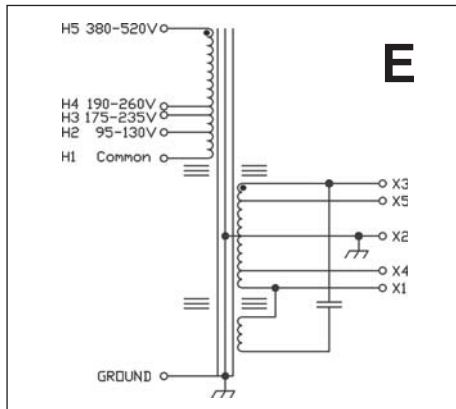

Primary Voltage	Interconnect	Connect Lines To
120		H1 & H2
208		H1 & H3
240		H1 & H4
480		H1 & H5
Secondary Voltage	Interconnect	Connect Lines To
120		X1 & X2 or X3 & X2
208		X4 & X5
240		X1 & X3

MCR 60 Hz 500-5000 VA

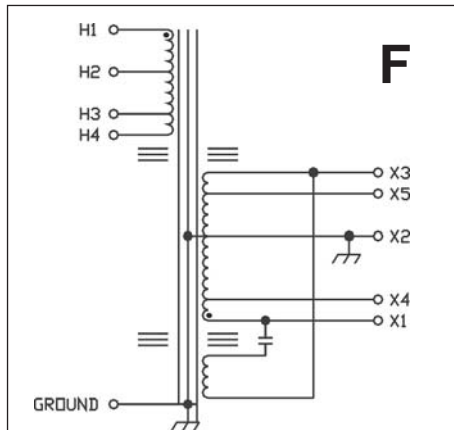

Primary Voltage	Interconnect	Connect Lines To
208		H2 & H3
240		H2 & H4
480		H1 & H4
Secondary Voltage	Interconnect	Connect Lines To
120		X1 & X2 or X3 & X2
208		X4 & X5
240		X1 & X3

MCR 60 Hz 7500, 10000 and 15000 VA

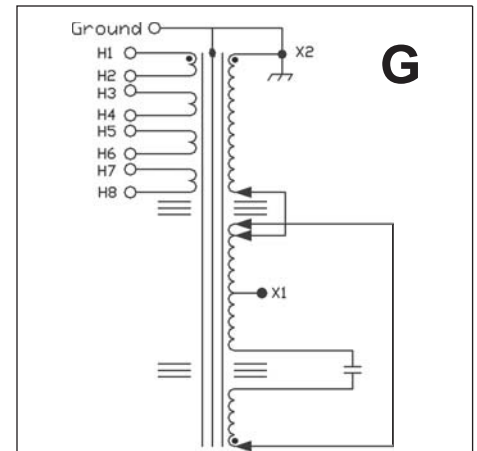

Primary Voltage	Interconnect	Connect Lines To
120	H1 to H3 H5 to H7 H2 to H4 H6 to H8	H1 & H2
240	H2 to H3 H6 to H7 H1 to H5 H4 to H8	H1 & H4
480	H2 to H3 H4 to H5 H6 to H7	H1 & H8
Secondary Voltage	Interconnect	Connect Lines To
120		X1 & X2

CVS 60 Hz 250 VA only

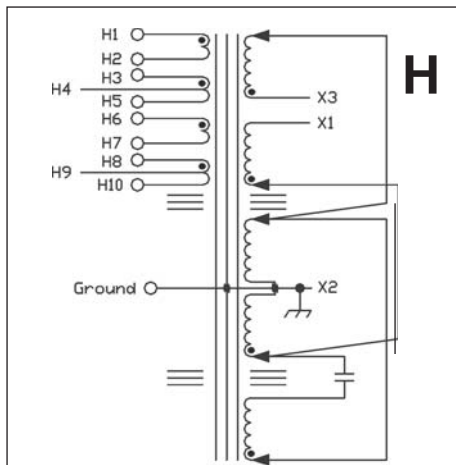

Primary Voltage	Interconnect	Connect Lines To
120	H1 to H3 to H6 to H8 H2 to H5 to H7 to H10	H1 & H2
208	H2 to H3 H7 to H8 H1 to H6 H4 to H9	H1 & H4
240	H2 to H3 H7 to H8 H1 to H6 H5 to H10	H1 & H5
480	H2 to H3 H5 to H6 H7 to H8	H1 & H10
Secondary Voltage	Interconnect	Connect Lines To
120		X1 & X2 or X3 & X2
240		X1 & X3

CVS 60 Hz 500-5000 VA

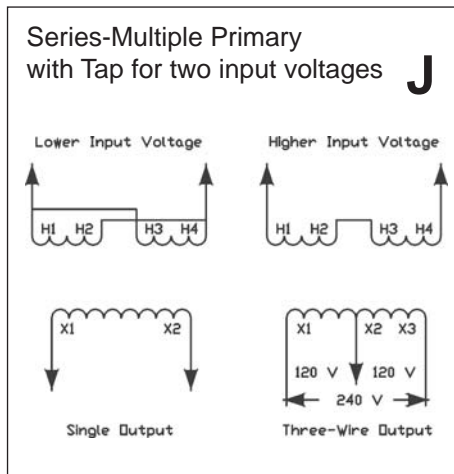

30 & 60 VA Primary Voltage	120 VA Primary Voltage	7500 VA Primary Voltage	Interconnect	Connect Lines To
120	N/A	N/A	Note: H3 & H4 are not used	H1 & H2
N/A	120	240	H1 to H3 H2 to H4	H1 & H4
N/A	240	480	H2 to H3	H1 & H4
30 & 60 VA Secondary Voltage	120 VA Secondary Voltage	7500 VA Secondary Voltage	Interconnect	Connect Lines To
120	120	N/A		X1 & X2
N/A	N/A	120		X1 & X2 or H3 & X2
N/A	N/A	240		X1 & X3

CVS 60 Hz 30-120 VA & 7500 VA

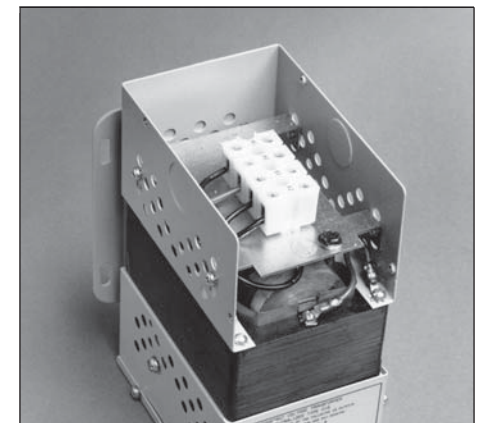

Open MCR/ CVS terminal

Note:
Secondaries are not grounded.
Ground X₂ per Code.

Model Comparison

Description	Hardwired CVS	Hardwired MCR	Portable MCR
VA Ratings	30 to 7500 VA	120 to 15000 VA	70 to 3000 VA
Input Voltage Range	+10/-20% of nominal		
Voltage Regulation	±1% for an input line variation of +10/-20%. No loss of output for line loss of 3 msec.	±3% for an input line variation of +10/-20% (50 Hz hardwired units ±5%.) No loss of output for complete line loss of 3 msec.	
Overload	Limits output current to 1.65 x rated current at nominal input.		
Output Harmonic Distortion	3% total RMS content at full load.		
Noise Isolation	40 dB common and normal code.	120 dB common mode and 60 dB normal mode.	
Surge Suppression	Up to 6000 Volt surges are suppressed to a let through of less than 1% per ANSI/IEEE C62.41 Class A & B waveforms.	ANSI/IEEE C62.41 Class A & B 6000 waveforms are suppressed to a let-through of less than 0.2%.	
Efficiency	Up to 92% at full load		Up to 90% at full load
Operating Temperature	-20°C to 50°C		-20°C to 40°C
Audible Noise	32 dB to 65 dB	35 dB to 65 dB	34 dB to 49 dB
Conformance	Listed to UL 1012. CSA Certified	UL Listed and CSA Certified. 50 Hz models in compliance with Low Voltage Directive Specification EN60950.	Listed to UL 1012. CSA Certified on all models except 3000 VA.
Warranty	10 + 2 years		

Note: All values are typical and may vary based on VA ratings of actual units.

BTU Output Chart for CVS and MCR Series

VA Ratings	120	250	500	750	1000	1500	2000	3000	5000	7500	10000	15000
Total BTU's	136	225	280	444	519	686	1229	1331	2117	2407	3209	4813

Note: Ratings are for a 40°C ambient temperature.

Operating Characteristics of the CVS & MCR Series

Regulation

Sola/Hevi-Duty's CVS power conditioners will hold output voltages to $\pm 1.0\%$ or less with input variations as great as $\pm 15\%$ (115V $\pm 15\%$ or 120 V +10%/-20%). Units operated at less than rated load will maintain approximately $\pm 1\%$ regulation over a wider input line voltage variation. Output meets NEMA voltage specifications even when input voltage drops to 65% of nominal. The output versus input voltage relationship for a typical CVS is shown in Figure A.

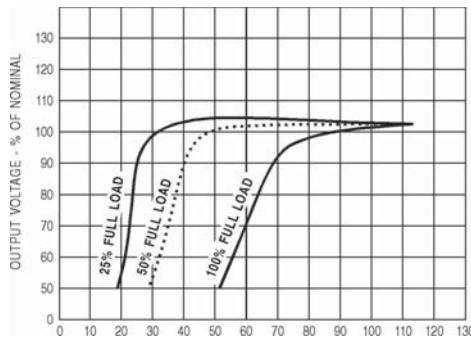

Figure A: Load Variation

Note: MCR line regulations: $\pm 3\%$ for 60 Hz; $\pm 5\%$ for 50 Hz. The typical performances shown in Figure B indicate that most of the residual changes take place near the lower (95 V) and upper (130 V) ends of the input range. It is possible to improve output regulation if line variations remain within a restricted range near the center of the nameplate range (for example, 100-120 V).

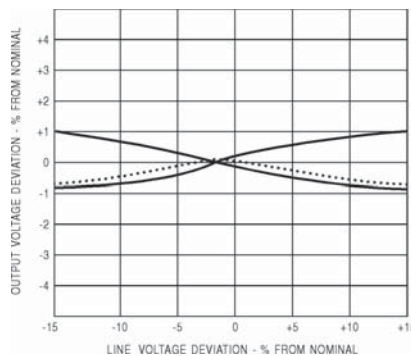

Figure B: Line Regulation

Normally, the output voltage will rise as the load is decreased. Typical percentages for changes in resistive load from full to zero load as shown below.

Except as noted, all characteristics of Sola/Hevi-Duty's CVS products also apply to the MCR series.

CVS Conditioner Rating - VA	Increase in Output Voltage due to Load Removal
30	3%
60 & 120	2%
250 & over	1%

Input Characteristics

Sola/Hevi-Duty power conditioners include a resonant circuit that is energized whether or not it is serving load. The input current at no load or light load may run 50% or more of the full primary current. As a result, the temperature of the unit may rise to substantially full-load level, even at light or no load. Input power factor will average 90-100% at full load, but may drop to about 75% at half load and 25% at no load. In any case, the current is always leading. The input no load watts are about 12.5% of the VA rating.

Frequency

Output voltage varies linearly with a change of frequency of the input voltage. This change is about 1.5% of the output voltage for each 1% change in input frequency and in the same direction as the frequency change.

Power Factor

Sola/Hevi-Duty power conditioners regulate any power factor load. Output voltage is a function of load current and load power factor (see Figure C). If lower voltage under lagging power factor is objectionable, correction may be made with capacitors at the load. "Median" value of output voltage will vary from the nameplate rating if the load has a power factor other than that for which the transformer was designed. Load regulation will also be relatively greater as the inductive load power factor is decreased (see Figure C). However, the resulting median values of output voltage will be regulated against supply line changes at any reasonable load or load power factor.

Operating Characteristics of the CVS & MCR Series

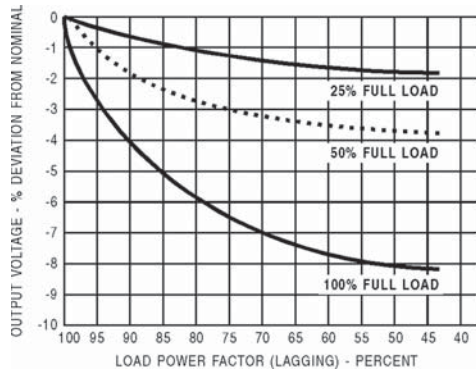

Figure C: Power Factor

Efficiency

The copper magnet wire and lamination material used in Sola/Hevi-Duty ferroresonant products are selected to achieve efficiencies of 90% or higher. Whether or not an external load is being served, current will be drawn from the line whenever the primary is energized, since the capacitor remains connected in the circuit.

Overload and Short Circuits

When the load is increased beyond the regulator's rated value, a point is reached where the output voltage suddenly collapses and will not regain its normal value until the load is partially released. Under direct short circuit, the load current is limited to approximately 150-200% of the rated full load value and the input watts to less than 10% of normal.

A constant voltage regulator will protect both itself and its load against damage from excessive fault currents. Fusing of load currents may not be necessary. The actual value of short-circuit current varies with the specific design and rating. Units may be operated indefinitely at short-circuit. This characteristic protects the unit itself as well as the load and load circuit being served. Typical overload performance is shown in Figure D.

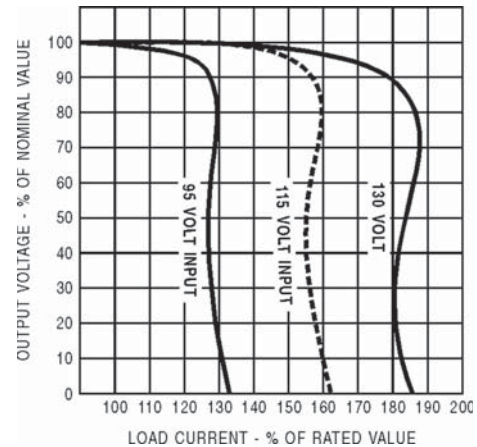

Figure D: Overload Performance

Motor Loads

Because of the fast response time of the Sola circuit, any current-limiting characteristic must be taken into account for transient overloads such as motor starting and solenoid operation. In general, the Sola constant voltage regulator must have a capacity nearly equal to the maximum demand made on it, even for an instant. To determine the power rating of the regulator, peak motor-starting current or solenoid inrush current should be measured or power factor correcting capacitors should be used to reduce the starting VA of the load.

Response Time

An important advantage of Sola's ferroresonant transformer is its fast response time compared with other types of AC regulators. Transient changes in supply voltage are usually corrected within 1-1/2 cycles or less; the output voltage will not fluctuate more than a few percent, even during this interval.

Operating Characteristics of the CVS & MCR Series

Temperature

Sola's ferroresonant power conditioners are very stable with respect to temperature. The change in output voltage is only 0.025%/°C. Units are factory adjusted to +2%/-0% of nominal, with full load and nominal input voltage. This adjustment to the high side of nominal is to compensate for the natural temperature drift of about 1% that takes place during initial turn-on or warm-up. When the unit warms up to operating temperature, the voltage typically falls about 1%.

At a stable operating temperature, the output voltage will change slightly with varying ambient temperatures. This shift is equal to approximately 1% for each 40°C of temperature change. The normal maximum temperature rise of a Sola power conditioner may fall anywhere in the range of 40°C to 110°C depending on the type and rating. The nominal design ambient range is between -20°C and +50°C (-20°C to +40°C for 70 - 1000 VA, 60 Hz portable models).

External Magnetic Field

In almost all applications, this effect may be disregarded. The exclusive Sola/Hevi-Duty "wide outside leg" construction (U.S. Patent 2,806,199) reduces stray magnetic fields to a practical minimum. On critical applications, care should be taken in orientation of the core with respect to critical circuits to minimize the effect of the field.

Phase Shift

The phase difference which exists between input and output voltages is in the range of 120 degrees to 140 degrees at full load. This phase difference varies with the magnitude and power factor of the load, and to a lesser extent, with changes in line voltage and load power factor.

Transient Protection

Ferroresonant power conditioners protect input transients (caused by lightning and load switching) from damaging the sensitive electronic load. A typical surge protective device (SPD) tries to 'clamp' a transient by diverting it to ground. A ferroresonant power conditioner "blocks" the transient. This 'blocking' action is achieved by total physical separation from input (primary) to output (secondary). Because of this difference in operation, it is difficult to apply the same specifications to a ferroresonant power conditioner. Some parallels can be made however.

One, is that under load, the let-through voltage of a ferroresonant power conditioner (SPD refer to "clamping voltage") is less than 10 V above the point where the sine wave would normally be at any given time. The ferroresonant power conditioner is an 'active tracking' suppressor with several advantages. The Ferro power conditioner will not shunt the transient to the ground line as SPD devices typically do. Shunting the transient to ground can cause the disturbance to be transmitted to other sensitive loads within a facility. This can pose serious problems with electronic or microprocessor-based equipment, especially if there is poor grounding within a facility. Other advantages provided by ferroresonant power conditioners include noise filtering, filtering of harmonic distortion and protection against voltage fluctuations such as sags or swells. These features are not provided by standard surge suppression devices but are often misrepresented or misused by SPD manufacturers trying to market their product as a "Do All" power quality device.

X-ON Electronics

Largest Supplier of Electrical and Electronic Components

Click to view similar products for [Power Conditioning](#) category:

Click to view products by [Sola](#) manufacturer:

Other Similar products are found below :

[63236258](#) [STFE100-24L](#) [A2D130HW](#) [STFE050-24L](#) [STFE030-24L](#) [Thyro-S 1S 400-100 H3](#) [Thyro-AX 3A 600-100 HF RLP2](#) [2000000405](#)
[CSB-02](#) [Thyro-PX 2PX 500-280 HF](#) [2000190002](#) [Thyro-A 2A 500-30 HRL3](#) [Thyro-S 1S 230-100 HRLP3](#) [Thyro-A 1A 230-170 HRL3](#)
[Thyro-A 1A 230-100 HRL3](#) [Thyro-S 1S 500-60 HRLP3](#) [Thyro-S 1S 230-60 HRLP3](#) [Thyro-S 1S 500-30 HRLP3](#) [Thyro-A 1A 230-45 HRLP3](#)
[C09](#) [Thyro-A 2A 400-60 H3](#) [Thyro-A 2A 400-30 H3](#) [3C33991FT0CG](#) [DBUF20-24](#) [DBUF40-24](#) [STFE10010N](#) [STV100K10Y](#) [LC1200](#)
[STFE030-10N](#) [STFE200-24L](#) [STFE050-10N](#) [PDA-SURGE](#) [Thyro-A 1A 230-30 HRL3](#) [Thyro-A 2A 500-100 HRL3](#) [63-23-210-C8](#)
[23-23-210-8](#) [23-23-220-8](#) [23-23-230-8](#) [63-23-175-8](#) [63-23-220-8](#) [23-13-030-2](#) [23-13-060-2](#) [23-22-112-2](#) [23-23-125-8](#) [23-23-150-8](#)
[63-13-125-6](#) [63-23-112-4](#) [63-23-150-8](#) [63-23-650-8](#) [STV25K-10S](#) [LC2400](#)