

871



### »» Features

- High rating Micro ISO automotive relays up to 35A/14VDC.
- SPNO & SPDT of contact configuration.
- Skirted cover and plain cover are both available.
- Optional to be equipped with diode or resistor.
- Comply with RoHS-Directive 2011/65/EU, and ELV-Directive 2000/53/EC.

### »» Type List

Terminal style	Contact form	Designation (provided with)	Enclosure style			
			Dust cover	Dust cover /Fixed Base	Flux tight	Sealed type washable
Socket terminal	1A (SPNO)	-----	871-1A-D	871-1A-DF	871-1A-C	871-1A-S
		Resistor	871-1A-D-R1	871-1A-DF-R1	871-1A-C-R1	871-1A-S-R1
		Diode	871-1A-D-D1	871-1A-DF-D1	871-1A-C-D1	871-1A-S-D1
	1C (SPDT)	-----	871-1C-D	871-1C-DF	871-1C-C	871-1C-S
		Resistor	871-1C-D-R1	871-1C-DF-R1	871-1C-C-R1	871-1C-S-R1
		Diode	871-1C-D-D1	871-1C-DF-D1	871-1C-C-D1	871-1C-S-D1

### »» Ordering Information

871 - 1A - C -    
 1 2 3 4 5

1. 871 -- Basic series designation
2. 1A -- Single pole normally open  
1C -- Single pole double throw
3. D -- Dust cover  
DF -- Dust cover / base holder type available  
C -- Flux tight  
S -- Sealed type washable
4. Blank -- Standard type  
R1 -- Coil parallel with 1/2W resistor for 6V 180Ω, 12V 680Ω, 24V 2700Ω  
D1 -- Coil parallel with diode IN4007 the positive pole on # 85 terminal
5.  -- Coil voltage (please refer to the coil rating data for the availability)

### »» Contact Rating

Resistive load	1A	1C
	35A 14VDC 15A 28VDC	NO: 35A 14VDC , 15A 28VDC NC: 20A 14VDC , 10A 28VDC

### »» Coil Rating (DC)

Rated voltage (V)	Rated current ±10 % at 23°C (mA)	Coil resistance ±10 % at 23°C (Ω)	Max. continuous voltage at 85°C	Pick up voltage(Max.) at 23°C	Drop out voltage(Min.) at 23°C	Power consumption at rated voltage
6	187.5	32	133 % of rated voltage	60 % of rated voltage	10 % of rated voltage	approx. 1.2W
12	97.5	123				
24	49.6	483				

## »» Specification

Contact material	AgSnO alloy	
Contact voltage drop <sup>(1)</sup>	Typ. 40mV at 10A	
Operate time <sup>(1)</sup>	10ms Max.	
Release time <sup>(1)</sup>	10ms Max.	
Insulation resistance <sup>(1)</sup>	20MΩ Min. (DC 500V)	
Dielectric strength <sup>(1)</sup>	Between open contact	: AC 500V , 50/60Hz 1 min.
	Between contact and coil	: AC 500V , 50/60Hz 1 min.
Vibration resistance	Operating extremes	10~500Hz , 5.0G
	Damage limits	10~500Hz , 5.0G
Shock resistance	Operating extremes	10G
	Damage limits	100G
Life expectancy	Mechanical	10,000,000 operations (frequency 18,000 operations/hr)
	Electrical	100,000 operations (frequency 1,800 operations/hr)
Temperature range	Operating	-40~+125°C (no freezing)
Weight	Approx. 20 g	

Note:(1)Initial value

## »» Outline Dimensions

## ◆871 (C,D)

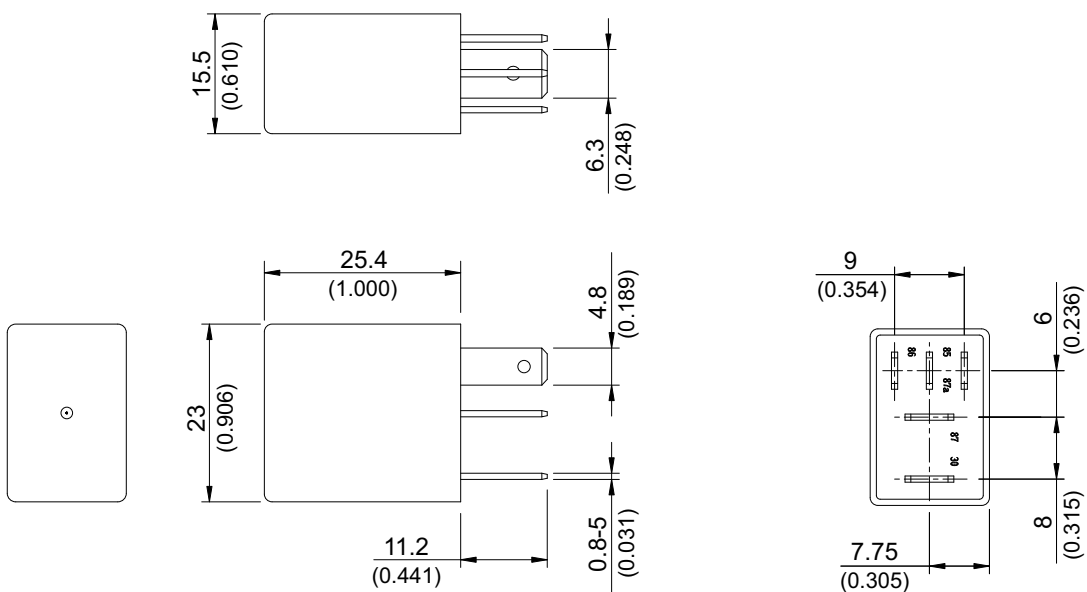

# 871

◆ 871 (DF)

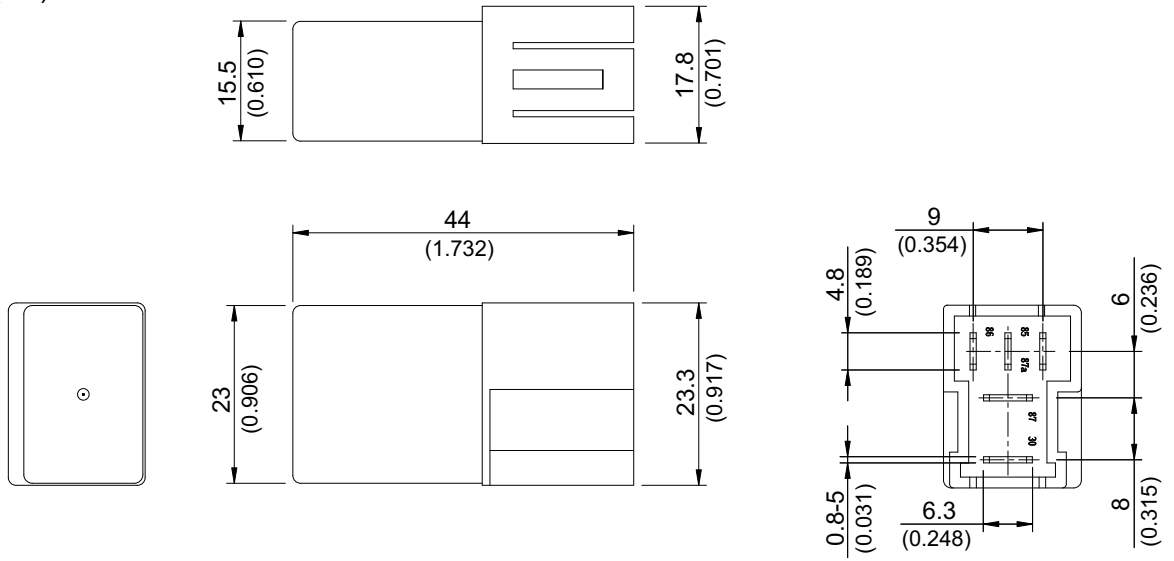

◆ 871 (S,V)

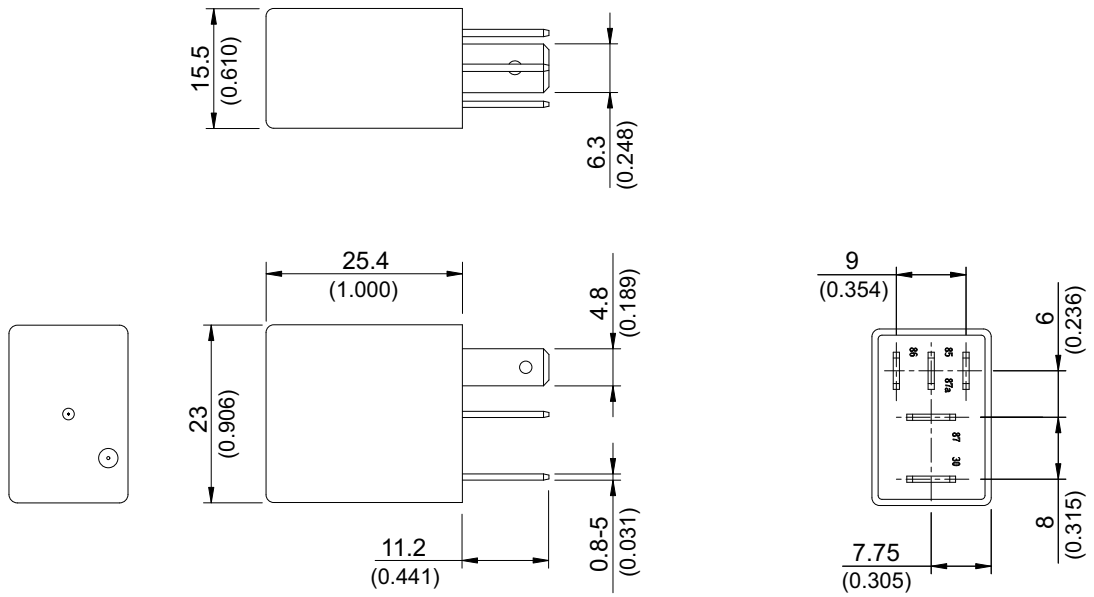

»» Wiring Diagram

BOTTOM VIEW

1C

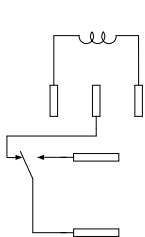

1A

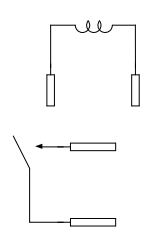

1C

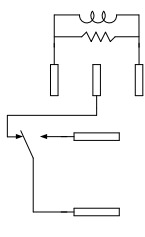

PROVIDED WITH RESISTOR

1A

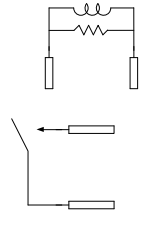

PROVIDED WITH RESISTOR

1C

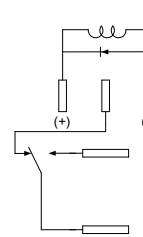

PROVIDED WITH DIODE

1A

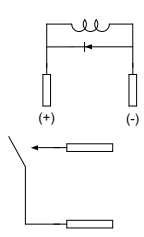

PROVIDED WITH DIODE

## »» Engineering Data

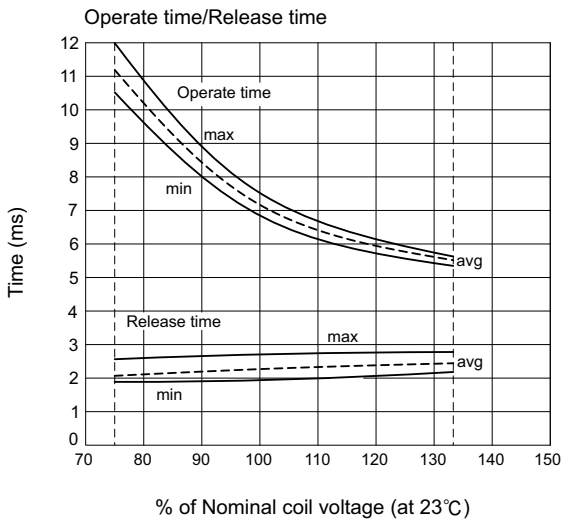
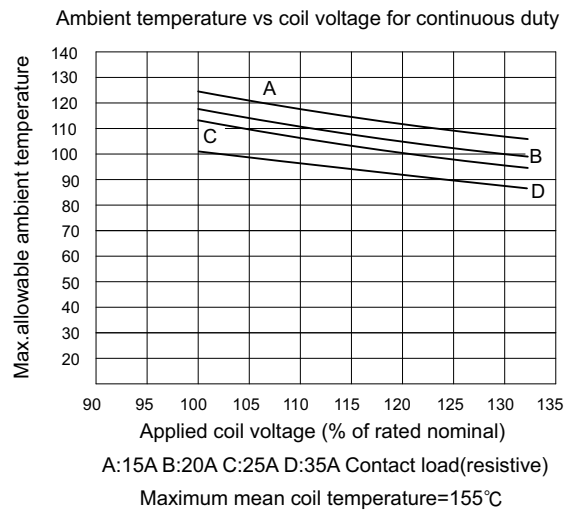
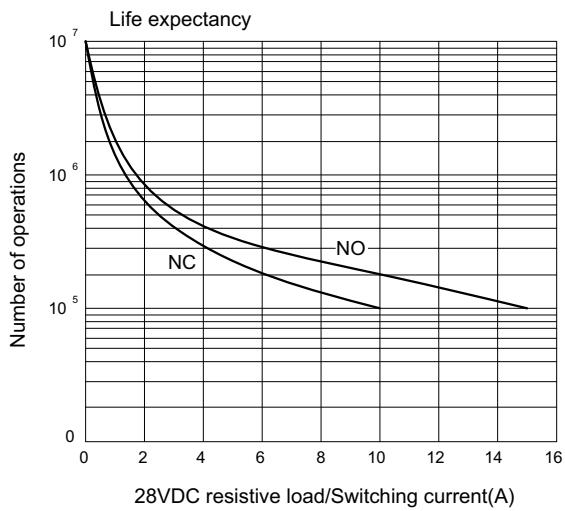
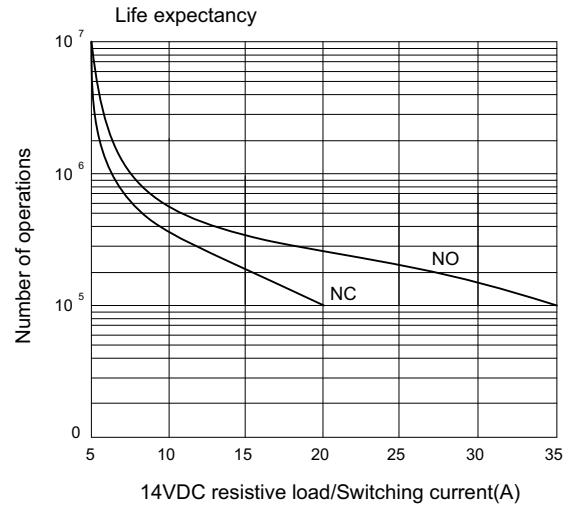
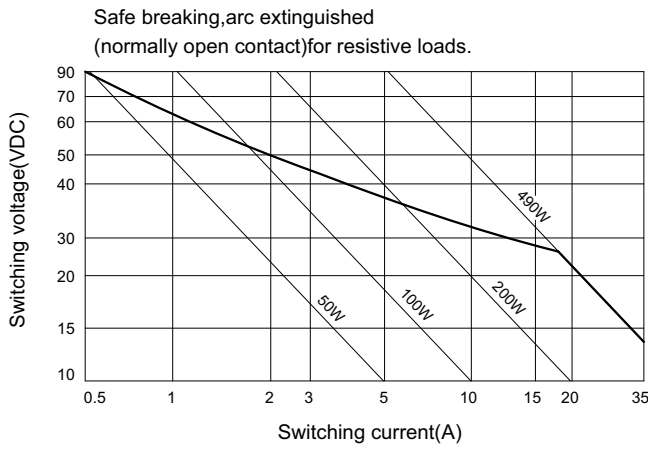

## X-ON Electronics

Largest Supplier of Electrical and Electronic Components

*Click to view similar products for [Automotive Relays](#) category:*

*Click to view products by [Song Chuan](#) manufacturer:*

Other Similar products are found below :

[7-1414968-8](#) [7-1617345-6](#) [9-1617516-5](#) [G5CE1ASIDC12](#) [1393204-2](#) [1393302-3](#) [13Z99A115-0074](#) [1432872-1](#) [AR4-15F11-S01](#) [AR4-15H11](#)  
[1617057-2](#) [1617058-6](#) [1617518-5](#) [2-1617057-2](#) [2-1617057-6](#) [2-1617058-3](#) [CB1F-M-12V-H15](#) [898H-1AH-D-001-12VDC](#) [AR4-11F11](#)  
[AR4-15F11](#) [AR4-41F11](#) [24198-1](#) [4-1617057-0](#) [41FZ-200ACG-BSL](#) [5-1616920-2](#) [5-1617052-9](#) [5407-0011-HS](#) [CB1AF-M-12V-H59](#) [5-](#)  
[1617346-8](#) [103-1AH-C-12VDC](#) [V23134A1052X299](#) [6-1393302-1](#) [897H-1AH-D-R1-U01-12VDC](#) [FTR-P3CP024W1-06](#) [1-1617057-8](#) [3-](#)  
[1393305-1](#) [5436-0001-HS](#) [V23086-R1851-A502](#) [V23136-A0004-X075](#) [898H-1AH-D1SW-R1-12VDC](#) [RH4C1P2607](#) [RE031005](#)  
[V23134M0052G242](#) [1393204-1](#) [23234B0001X001-EV-144](#) [AZ979-1A-24D](#) [2-1904020-1](#) [V23134B0052C642](#) [V23134B0053C642](#) [V23234-](#)  
[A1001-X036](#)