

875



»» Features

- Miniature PCB surge cube relay with highest rating 20A 125VAC, 16A 277VAC, TV-8 ratings with cadmium free contacts.
- CSA/CUS, TUV, UL/CUL approved.
- UL Class F and high temperature withstand up to 85 degree C.
- SPNO, SPNC, SPDT contact configurations, sealed flux free & sealed washable types are available.
- Ideal for motor control, compressor control for household appliances.
- Contact rating up to 16A 250VAC (SPNO).

»» Type List

Terminal style	Contact form	UL Insulation system approval	Designation (provided with)		
			Flux tight	Sealed type	Sealed type washable
PCB terminal	1A (SPNO)	-----	875B-1AC-C	875B-1AC-V	875B-1AC-S
		F	875B-1AC-F-C	875B-1AC-F-V	875B-1AC-F-S
		-----	875B-1AH-C	875B-1AH-V	875B-1AH-S
		F	875B-1AH-F-C	875B-1AH-F-V	875B-1AH-F-S
	1B (SPNC)	-----	875B-1BC-C	875B-1BC-V	875B-1BC-S
		F	875B-1BC-F-C	875B-1BC-F-V	875B-1BC-F-S
		-----	875B-1BH-C	875B-1BH-V	875B-1BH-S
		F	875B-1BH-F-C	875B-1BH-F-V	875B-1BH-F-S
	1C (SPDT)	-----	875B-1CC-C	875B-1CC-V	875B-1CC-S
		F	875B-1CC-F-C	875B-1CC-F-V	875B-1CC-F-S
		-----	875B-1CH-C	875B-1CH-V	875B-1CH-S
		F	875B-1CH-F-C	875B-1CH-F-V	875B-1CH-F-S

»» Ordering Information

875 B - 1A C - F - C
 1 2 3 4 5 6

- | | |
|---|-----------------------------------|
| 1. 875 -- Basic series designation | H -- Contact material AgSnO |
| | HA -- Contact material AgSnO + Au |
| 2. B -- Barrier provided between coil and frame | |
| 3. 1A -- Single pole normally open | 5. Blank -- Standard type |
| 1B -- Single pole normally closed | F -- Class F |
| 1C -- Single pole double throw | |
| 4. C -- Contact material AgNi | 6. C -- Flux tight |
| CA -- Contact material AgNi + Au | V -- Sealed type |
| | S -- Sealed type washable |

»» Contact Rating

	1A	1B	1C
Resistive load	16A 240VAC	12A 240VAC	NO/NC : 16A/12A 240VAC 16A 240VAC ^(*)

»» Coil Rating (DC)

Rated voltage (V)	Rated current ±10 % at 23 °C (mA)	Coil resistance ±10 % at 23 °C (Ω)	Max. continuous voltage at 85 °C	Pick up voltage(Max) at 23 °C	Drop out voltage(Min) at 23 °C	Power consumption at rated voltage
3	120	25	150 % of rated voltage	75 % of rated voltage	5 % of rated voltage	approx. 0.36W
5	73	69				
6	60	100				
9	40	225				
12	30	400				
18	20	900				
24	15	1600				
36	10	3600				
48	7.5	6400				

»» Specification

Contact material	AgSnO / AgNi alloy	
Contact resistance ⁽¹⁾	100mΩ Max.	
Operate time ⁽¹⁾	15ms Max.	
Release time ⁽¹⁾	10ms Max.	
Insulation resistance ⁽¹⁾	100MΩ Min. (DC 500V)	
Dielectric strength ⁽¹⁾	Between open contact	: AC 1000V, 50/60Hz 1 min.
	Between contact and coil	: AC 2500V, 50/60Hz 1 min.
Vibration resistance	Operating extremes	10~50Hz , amplitude 1.0 mm
	Damage limits	10~50Hz , amplitude 1.0 mm
Shock resistance	Operating extremes	10G
	Damage limits	100G
Life expectancy	Mechanical	10,000,000 operations (frequency 18,000 operations/hr)
	Electrical	100,000 operations (※50,000 operations) (frequency 360 operations/hr)
Operating ambient temperature	-40~+85 °C (no freezing)	
Weight	Approx. 10 g	

Note : (1) initial value

»» Safety Approval

Certified	CSA / CUS	TUV	UL / CUL
File No.	1474282	R3-5006128	E88991

»» Safety Approval Rating

CSA / CUS, UL / CUL			
AgNi		AgSnO	
NO	NC	NO	NC
17A 250VAC 20A 125VAC 1HP 8FLA 250VAC	15A 250VAC 20A 125VAC 1/2HP 4.9FLA 250VAC 1/2HP 9.8FLA 125VAC	20A 125VAC 17A 250VAC 1HP 8FLA 250VAC 1HP 16FLA 125VAC 17FLA 30LRA 250VAC TV-8	20A 125VAC 10A 250VAC 1/2HP 4.9FLA 250VAC 1/2HP 9.8FLA 125VAC TV-8

TUV
16A 250VAC 20A 125VAC

»» Outline Dimensions

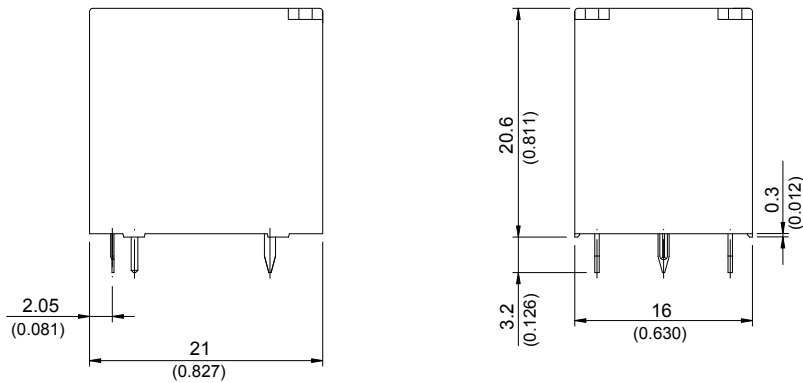

»» Wiring Diagram

BOTTOM VIEW

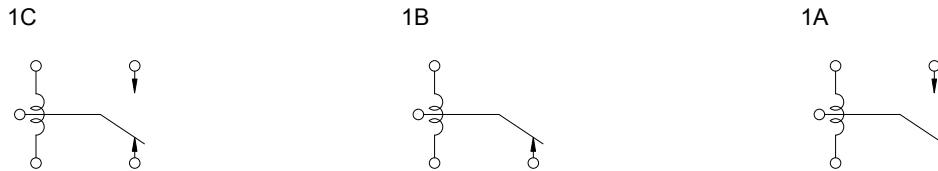

»» PC Board Layout

BOTTOM VIEW

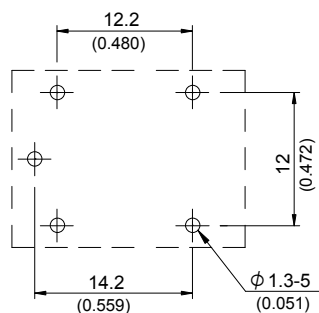

»» Engineering Data

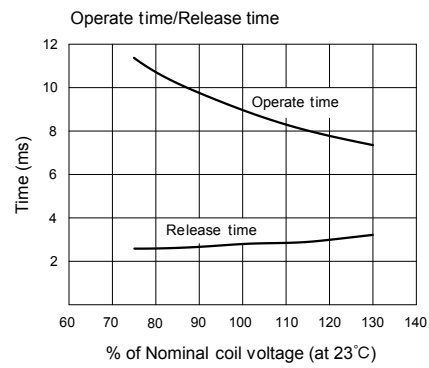
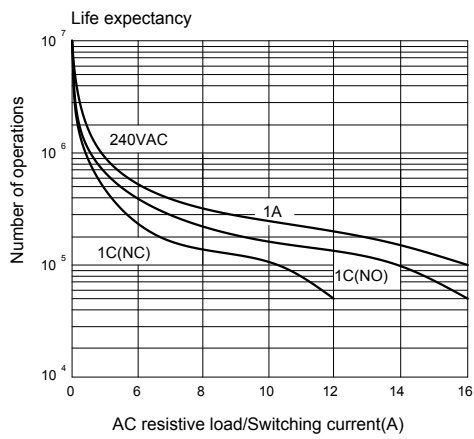
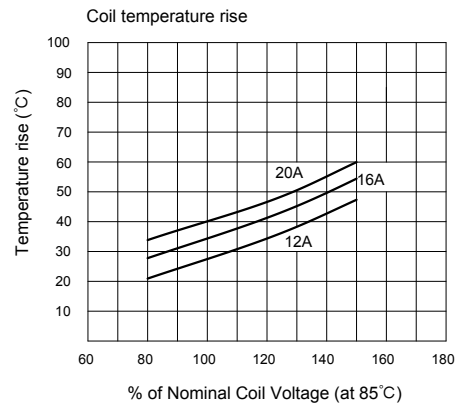
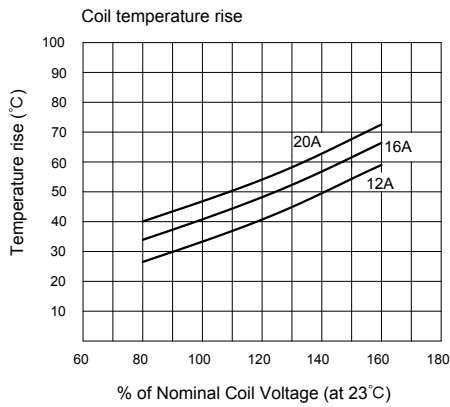

X-ON Electronics

Largest Supplier of Electrical and Electronic Components

Click to view similar products for [General Purpose Relays](#) category:

Click to view products by [Song Chuan](#) manufacturer:

Other Similar products are found below :

[PCN-105D3MH,000](#) [59641F200](#) [5JO-1000CD-SIL](#) [LY1SAC110120](#) [5X827E](#) [5X837F](#) [5X840F](#) [5X842F](#) [5X848E](#) [LY2N-AC120](#) [LY2S-AC220/240](#) [LY2-US-AC120](#) [LY3-US-AC120](#) [LY4F-UA-DC12](#) [LY4F-UA-DC24](#) [LY4F-US-AC120](#) [LY4F-US-AC240](#) [LY4F-US-DC24](#) [LY4F-VD-AC110](#) [LYQ20DC12](#) [M115C60](#) [M115N010](#) [M115N0150](#) [6031007G](#) [603-12D](#) [61211T0B4](#) [61212T400](#) [61222Q400](#) [61243B600](#) [61243C500](#) [61243Q400](#) [61311BOA2](#) [61311BOA6](#) [61311BOA8](#) [61311C0A2](#) [61311COA1](#) [61311COA6](#) [61311F0A2](#) [61311QOA1](#) [61311QOA4](#) [61311T0D6](#) [61311TOA6](#) [61311TOA7](#) [61311TOB3](#) [61311TOB4](#) [61311U0A6](#) [61312Q600](#) [61312T400](#) [61312T600](#) [61313U200](#)