

»» Features



- 15A general purpose Power Relays.
- UL/CUL,CSA,TUV approved.
- Optional for AC & DC coil.
- Optional with and or w/out lamp, push-to-test button, stud, etc.
- Sealed and washable type w/ knock-off nib vent.
- Plain or top flange cover, PCB and or solder lug / quick terminals.
- Contact rating up to 15A 250VAC (SPNO).
- Comply with RoHS-Directive 2002/95/EC.

»» Type List

Terminal style	Contact form	Designation (provided with)	Enclosure style	
			Dust cover	Flanged cover
S (Quick terminal)	1C (SPDT)	-----	SCLA-S-SPDT-C	SCLA-S-SPDT-C1
	1A (SPNO)		SCLA-S-SPNO-C	SCLA-S-SPNO-C1
	1B (SPNC)		SCLA-S-SPNC-C	SCLA-S-SPNC-C1
	1C (SPDT)	Lamp	SCLA-S-L-SPDT-C	SCLA-S-L-SPDT-C1
	1A (SPNO)		SCLA-S-L-SPNO-C	SCLA-S-L-SPNO-C1
	1B (SPNC)		SCLA-S-L-SPNC-C	SCLA-S-L-SPNC-C1
	1C (SPDT)	Manual	SCLA-S-M-SPDT-C	SCLA-S-M-SPDT-C1
	1A (SPNO)		SCLA-S-M-SPNO-C	SCLA-S-M-SPNO-C1
	1B (SPNC)		SCLA-S-M-SPNC-C	SCLA-S-M-SPNC-C1
	1C (SPDT)	Lamp & Manual	SCLA-S-LM-SPDT-C	SCLA-S-LM-SPDT-C1
	1A (SPNO)		SCLA-S-LM-SPNO-C	SCLA-S-LM-SPNO-C1
	1B (SPNC)		SCLA-S-LM-SPNC-C	SCLA-S-LM-SPNC-C1
P (PCB terminal)	1C (SPDT)	-----	SCLA-P-SPDT-C	-----
	1A (SPNO)		SCLA-P-SPNO-C	-----
	1B (SPNC)		SCLA-P-SPNC-C	-----
	1C (SPDT)	Lamp	SCLA-P-L-SPDT-C	-----
	1A (SPNO)		SCLA-P-L-SPNO-C	-----
	1B (SPNC)		SCLA-P-L-SPNC-C	-----
	1C (SPDT)	Manual	SCLA-P-M-SPDT-C	-----
	1A (SPNO)		SCLA-P-M-SPNO-C	-----
	1B (SPNC)		SCLA-P-M-SPNC-C	-----
	1C (SPDT)	Lamp & Manual	SCLA-P-LM-SPDT-C	-----
	1A (SPNO)		SCLA-P-LM-SPNO-C	-----
	1B (SPNC)		SCLA-P-LM-SPNC-C	-----

»» Ordering Information

SCL A - S - □ - SPNO - □ - C
 1 2 3 4 5 6 7

- | | | | |
|----------|----------------------------------|----------|--------------------------------|
| 1. SCL | -- Basic series designation | 5. SPNO | -- Single pole normally open |
| 2. A | -- Single pole | SPNC | -- Single pole normally closed |
| 3. P | -- PCB terminal | SPDT | -- Single pole double throw |
| S | -- Quick terminal | 6. Blank | -- Standard type |
| 4. Blank | -- Without pilot light | F | -- Class F |
| L | -- Provided with pilot light | 7. C | -- Dust cover |
| M | -- Provided with manual operator | C1 | -- Flanged cover |

»» Contact Rating

Resistive load	15A 240VAC	15A 28VDC
----------------	------------	-----------

»» Coil Rating (DC)

Rated voltage (V)	Rated current ±10 % at 23°C (mA)	Coil resistance ±10 % at 23°C (Ω)	Max. continuous voltage at 70°C	Pick up voltage(Max) at 23°C	Drop out voltage(Min) at 23°C	Power consumption at rated voltage
6	150	40	120 % of rated voltage	75 % of rated voltage	10 % of rated voltage	approx. 0.9W
12	75	160				
15	60	250				
24	37	650				
48	19	2600				
110	10	11000				
120	11	11000				

»» Coil Rating (AC)

Rated voltage (V)	Coil resistance ±10 % at 23°C (Ω)	Max. continuous voltage at 70°C	Pick up voltage(Max) at 23°C	Drop out voltage(Min) at 23°C	Power consumption at rated voltage
12	40	110 % of rated voltage	85 % of rated voltage	30 % of rated voltage	approx. 1.2VA
24	160				
100	3400				
110	3400				
115	3400				

120	3400	110 % of rated voltage	85 % of rated voltage	30 % of rated voltage	approx. 1.2VA
220	13600				
230	13600				
240	13600				

»» Specification

Contact material	AgSnO alloy	
Contact resistance ⁽¹⁾	30mΩ Max. (1A/6VDC by 4 pipes mΩ meter)	
Operate time ⁽¹⁾	25 ms Max.	
Release time ⁽¹⁾	25 ms Max.	
Insulation resistance ⁽¹⁾	100 MΩ Min. (DC 500V)	
Dielectric strength ⁽¹⁾	Between live parts & ground : AC 1500V , 50/60Hz 1 min.	
	Between contact and coil : AC 1500V , 50/60Hz 1 min.	
	Between open contact : AC 1000V , 50/60Hz 1 min.	
Vibration resistance	Operating extremes	10~55Hz , amplitude 1.0 mm
	Damage limits	10~55Hz , amplitude 1.0 mm
Shock resistance	Operating extremes	20G
	Damage limits	100G
Life expectancy	Mechanical	10,000,000 operations (frequency 18,000 operations/hr)
	Electrical	100,000 operations (frequency 1,800 operations/hr)
Operating ambient temperature	-25~+70°C (no freezing)	
Weight	Approx. 32 g	

Note : (1) initial value.

»» Safety Approval

Certified	UL / CUL	CSA	TUV
File No.	E88991	1474292	R9452081

»» Safety Approval Rating

UL / CUL	CSA	TUV
15A 277VAC (※)	10A 277VAC	15A 250VAC
18A 120VAC (※)	15A 28VDC	15A 30VDC
15A 120VAC	15A, 1/2HP 120VAC	6.2A 120VAC cos φ 0.5
10A 277VAC		
15A 28VDC		
1/2HP 120VAC		

Note : (※) For non-industrial application.

»» Outline Dimensions

◆LA-S C1

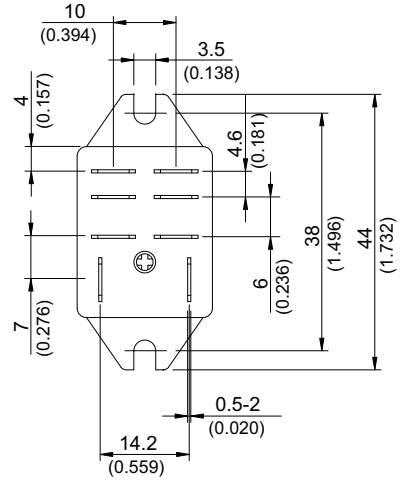
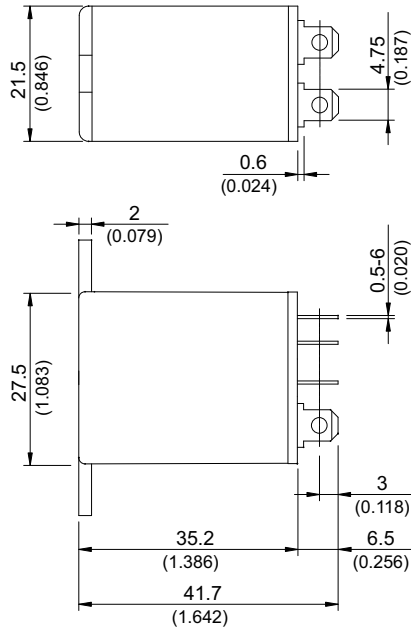

◆LA-S C

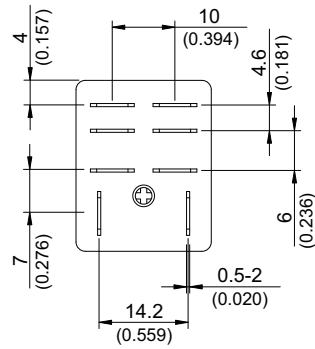
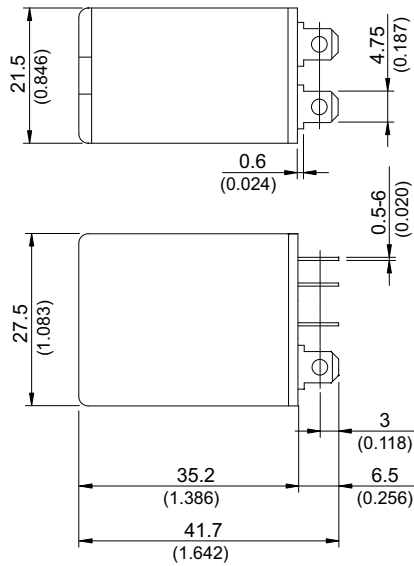

◆ LA-P C

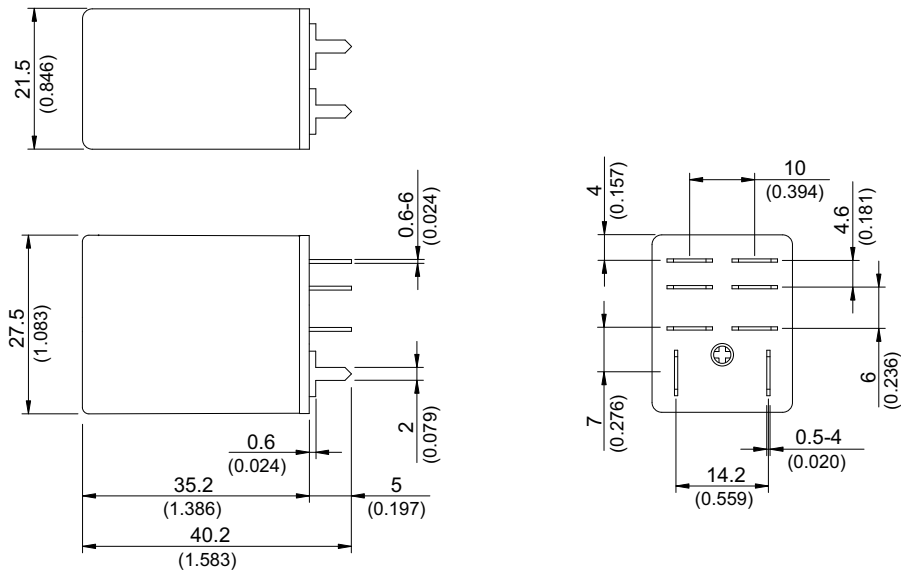

»» Wiring Diagram
 BOTTOM VIEW

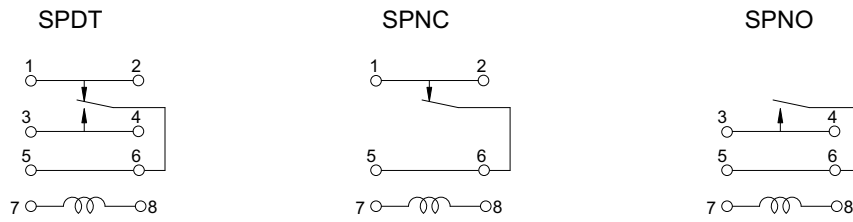

»» PC Board Layout
 BOTTOM VIEW

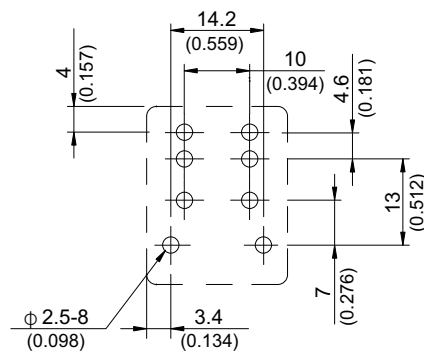

»» Designation (Provided with) BOTTOM VIEW

Lamp

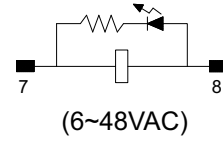
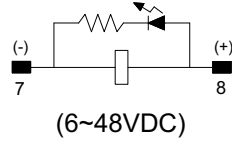
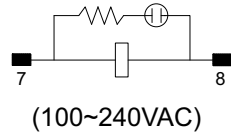

Diode

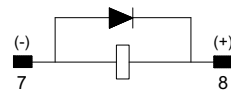

»» Engineering Data

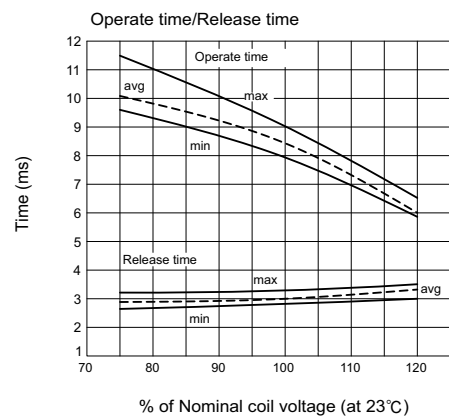
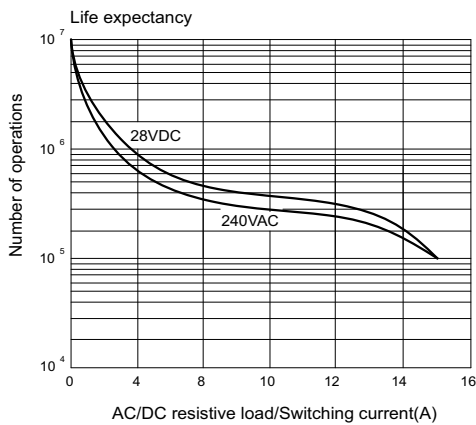
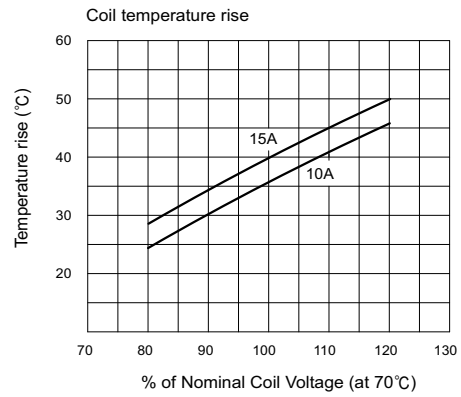
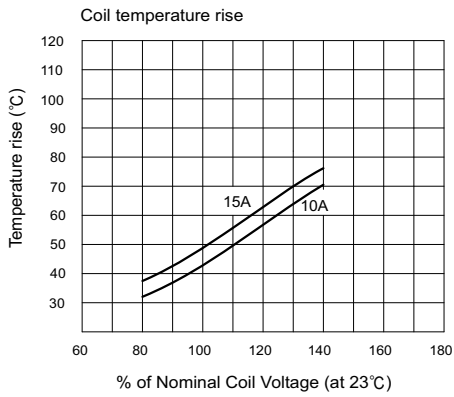

X-ON Electronics

Largest Supplier of Electrical and Electronic Components

Click to view similar products for [General Purpose Relays](#) category:

Click to view products by [Song Chuan](#) manufacturer:

Other Similar products are found below :

[PCN-105D3MH,000](#) [59641F200](#) [LY1SAC110120](#) [5X827E](#) [5X837F](#) [5X840F](#) [5X842F](#) [5X848E](#) [LY2N-AC120](#) [LY2S-AC220/240](#) [LY2-US-AC120](#) [LY3-US-AC120](#) [LY4F-UA-DC12](#) [LY4F-UA-DC24](#) [LY4F-US-AC120](#) [LY4F-US-AC240](#) [LY4F-US-DC24](#) [LY4F-VD-AC110](#) [LYQ20DC12](#) [M115C60](#) [M115N010](#) [M115N0150](#) [6031007G](#) [603-12D](#) [61211T0B4](#) [61212T400](#) [61222Q400](#) [61243B600](#) [61243C500](#) [61243Q400](#) [61311BOA2](#) [61311BOA6](#) [61311BOA8](#) [61311C0A2](#) [61311COA1](#) [61311COA6](#) [61311F0A2](#) [61311QOA1](#) [61311QOA4](#) [61311T0D6](#) [61311TOA6](#) [61311TOA7](#) [61311TOB3](#) [61311TOB4](#) [61311U0A6](#) [61312Q600](#) [61312T400](#) [61312T600](#) [61313U200](#) [61313U400](#)