

»» Features

- 10 general purpose Power Relay.
- Contact rating up to 12A 250VAC (DPNO).
- Epoxy sealed type and flux free.
- Quick connect terminal or PCB terminal available.
- Special version of larger contact gap 1.9mm. (IEC 255/VDE 0436) (DPNO Only)
- Optional to be equipped with lamp, diode, flashed contact, and flanged cover.
- Comply with RoHS-Directive 2002/95/EC.



»» Type List

Terminal style	Contact form	Designation (provided with)	Enclosure style			
			Straight cover	Flanged cover	Sealed type	Sealed type washable
Quick terminal	DPDT	-----	SCL-DPDT	SCL-DPDT-C1	SCL-DPDT-V	SCL-DPDT-S
	DPNO	-----	SCL-DPNO	SCL-DPNO-C1	SCL-DPNO-V	SCL-DPNO-S
	DPDT	Diode	SCL-D-DPDT	SCL-D-DPDT-C1	SCL-D-DPDT-V	SCL-D-DPDT-S
	DPNO	Diode	SCL-D-DPNO	SCL-D-DPNO-C1	SCL-D-DPNO-V	SCL-D-DPNO-S
	DPDT	Lamp	SCL-L-DPDT	SCL-L-DPDT-C1	SCL-L-DPDT-V	SCL-L-DPDT-S
	DPNO	Lamp	SCL-L-DPNO	SCL-L-DPNO-C1	SCL-L-DPNO-V	SCL-L-DPNO-S
PCB terminal	DPDT	-----	SCL-1-DPDT	-----	SCL-1-DPDT-V	SCL-1-DPDT-S
	DPNO	-----	SCL-1-DPNO	-----	SCL-1-DPNO-V	SCL-1-DPNO-S
	DPDT	Diode	SCL-1-D-DPDT	-----	SCL-1-D-DPDT-V	SCL-1-D-DPDT-S
	DPNO	Diode	SCL-1-D-DPNO	-----	SCL-1-D-DPNO-V	SCL-1-D-DPNO-S
	DPDT	Lamp	SCL-1-L-DPDT	-----	SCL-1-L-DPDT-V	SCL-1-L-DPDT-S
	DPNO	Lamp	SCL-1-L-DPNO	-----	SCL-1-L-DPNO-V	SCL-1-L-DPNO-S
	DPDT	Manual	SCL-1-M-DPDT	-----	-----	-----
	DPNO	Manual	SCL-1-M-DPNO	-----	-----	-----

»» Ordering Information

SCL - - - DPDT - -
 1 2 3 4 5 6

- | | | | |
|----------|--|----------|------------------------------|
| 1. SCL | -- Basic series designation | 4. DPDT | -- Double pole double throw |
| 2. Blank | -- Quick terminal | DPNO | -- Double pole normally open |
| 1 | -- PCB terminal | 5. Blank | -- Standard type |
| 3. Blank | -- Without special features | F | -- Class F |
| L | -- Provided with pilot light | 6. Blank | -- Straight cover |
| D | -- Diode across coil | C1 | -- Flanged cover |
| M | -- Provided with manual operator | V | -- Sealed type |
| H | -- 2 mm contact gap (For DPNO and DC coil type only) | S | -- Sealed type washable |

»» Contact Rating

◆ Standard Type

Resistive load	10A 240VAC , 10A 28VDC
----------------	------------------------

◆ SCL-H Type

Resistive load	15A 240VAC
Max. switching voltage	250VAC
Max. switching current	15A
Max. switching capacity	3600VA

»» Coil Rating (DC)

◆ Standard Type

Rated voltage (V)	Rated current $\pm 10\%$ at 23°C (mA)	Coil resistance $\pm 10\%$ at 23°C (Ω)	Max. continuous voltage at 70°C	Pick up voltage(Max) at 23°C	Drop out voltage(Min) at 23°C	Power consumption at rated voltage
6	150	40	110 % of rated voltage	75 % of rated voltage	10 % of rated voltage	approx. 0.9W
9	100	90				
12	75	160				
15	60	250				
24	37	650				
48	19	2600				
60	15	4000				
110	10	11000				
120	11	11000				

◆ SCL-H Type

Rated voltage (V)	Rated current $\pm 10\%$ at 23°C (mA)	Coil resistance $\pm 10\%$ at 23°C (Ω)	Max. continuous voltage at 70°C	Pick up voltage(Max) at 23°C	Drop out voltage(Min) at 23°C	Power consumption at rated voltage
3	400	7.5	115 % of rated voltage	80 % of rated voltage	10 % of rated voltage	approx. 1.2W
6	200	30				
9	133.3	67.5				
12	100	120				
24	50	480				
48	25	1920				
60	20	3000				
100	12	8330				
110	10.9	10080				
120	10	12000				

»» Coil Rating (AC)

Rated voltage (V)	Coil resistance $\pm 10\%$ at 23°C (Ω)	Max. continuous voltage at 70°C	Pick up voltage(Max) at 23°C	Drop out voltage(Min) at 23°C	Power consumption at rated voltage
12	40	110 % of rated voltage	85 % of rated voltage	30 % of rated voltage	approx. 1.2VA
24	160				
100	3400				
110	3400				
115	3400				
120	3400				
220	13600				
230	13600				
240	13600				

»» Specification

Contact material	AgSnO alloy	
Contact resistance ⁽¹⁾	30 m Ω Max. ; (-H) 50 m Ω Max. (1A/6VDC by 4 pipes m Ω meter)	
Operate time ⁽¹⁾	25 ms Max.	
Release time ⁽¹⁾	25 ms Max.	
Insulation resistance ⁽¹⁾	100 M Ω Min. (DC 500V)	
Dielectric strength ⁽¹⁾	Between open contact	: AC 1000V , 50/60Hz 1 min.
	Between contact and coil	: AC 1500V , 50/60Hz 1 min.
	Between contact circuits	: AC 1500V , 50/60Hz 1 min.
Vibration resistance	Operating extremes	10~55Hz , amplitude 1.0 mm
	Damage limits	10~55Hz , amplitude 1.0 mm
Shock resistance	Operating extremes	20G ; (-H) 10G
	Damage limits	100G ; (-H) 200G
Life expectancy	Mechanical	10,000,000 operations ; (-H) 3,000,000 ops. (frequency 18,000 operations/hr)
	Electrical	100,000 operations (frequency 1,800 operations/hr) [(-H)1,200 ops/hr]
Operating ambient temperature	-25~+70°C (no freezing)	
Weight	Approx. 35 g	

Note : (1) initial value

»» Safety Approval

◆ Standard Type

Certified	UL / CUL	CSA	TUV	FIMKO
File No.	E88991	1474290	R50055516	24561

◆ SCL-H Type

Certified	UL / CUL	TUV
File No.	E88991	R50055516

»» Safety Approval Rating

◆ Standard Type

UL / CUL	CSA	TUV	FIMKO
10A 277VAC/28VDC	10A 277VAC	10A 250VAC	10A 250VAC (DPDT)
15A 125VAC	10A 28VDC	10A 30VDC	15A 250VAC(DPNO)
1/3HP 7.5FLA 125VAC	1/2HP 7.5FLA 125VAC		
1/2HP 5.0FLA 250VAC	1/3HP 5.0FLA 240VAC		
1/3HP 3.0FLA 277VAC	15A 240VAC (DPNO ONLY)		
15A 240VAC (DPNO ONLY)			

◆ SCL-H Type

UL / CUL	TUV
16A 277VAC 1/2HP 250VAC	15A 250VAC

»» Outline Dimensions

◆ SCL (C1)

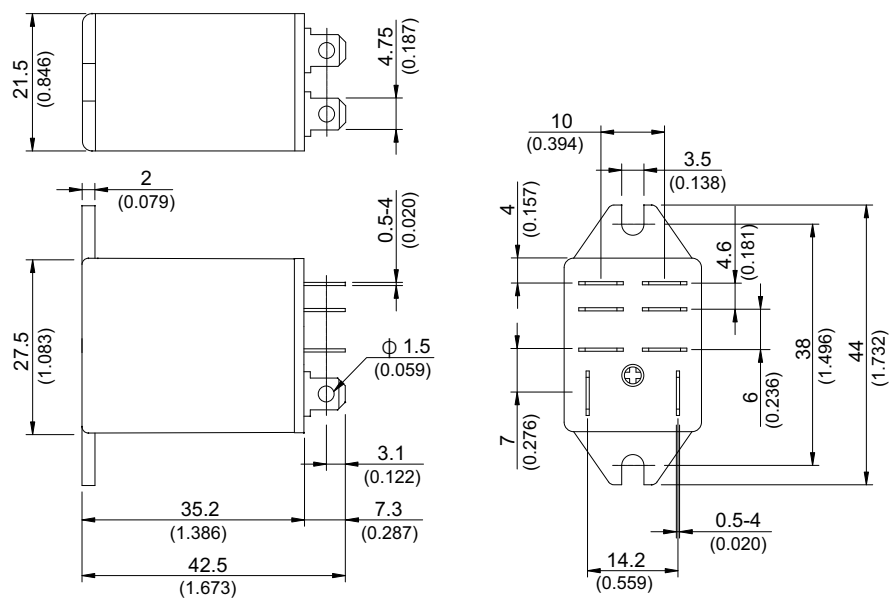

◆ SCL

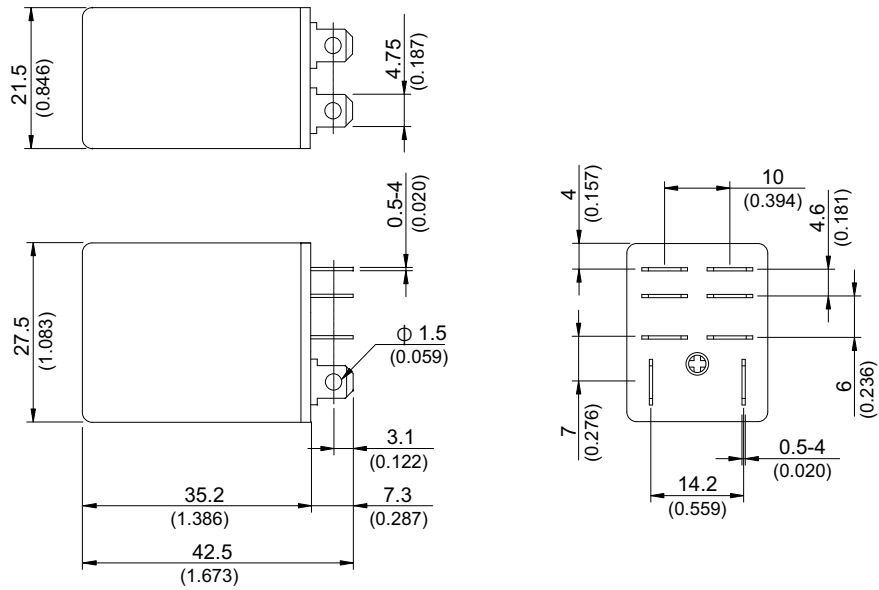

◆ SCL-1

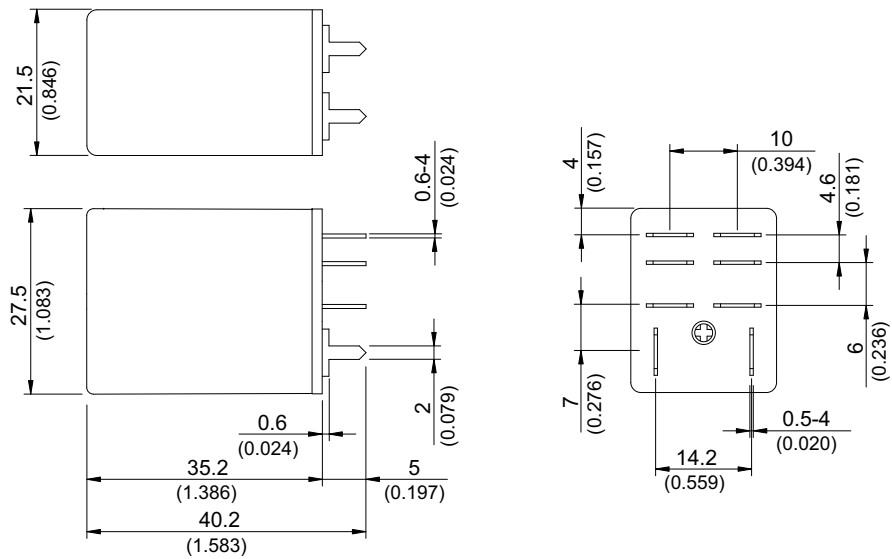

»» Wiring Diagram
BOTTOM VIEW

DPDT

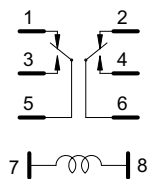

DPNO

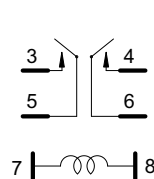

PC Board Layout BOTTOM VIEW

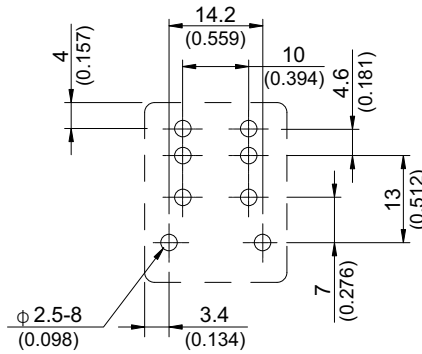

Designation(Provided with) BOTTOM VIEW

Lamp

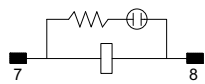

(100~240VAC)

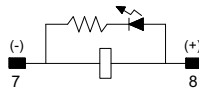

(6~48VDC)

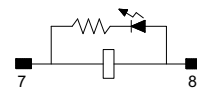

(6~48VAC)

Diode

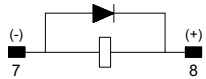

Engineering Data

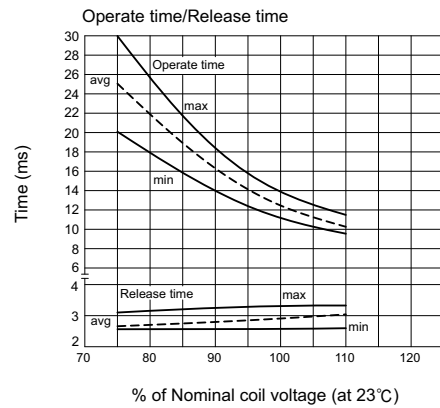
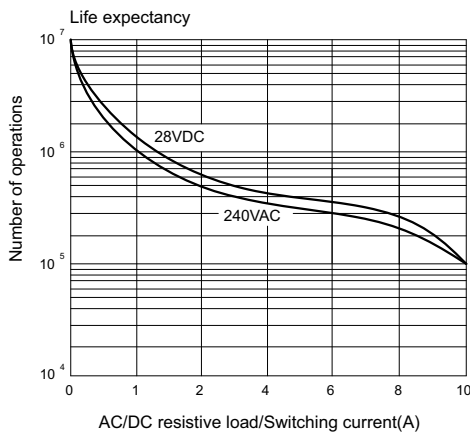
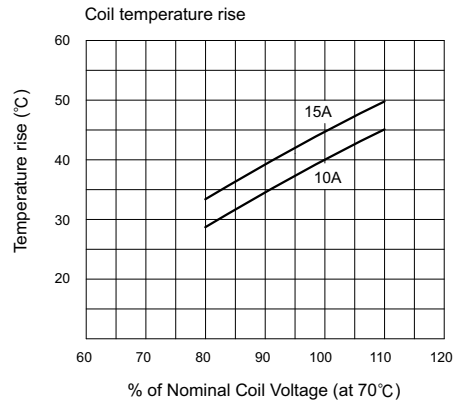
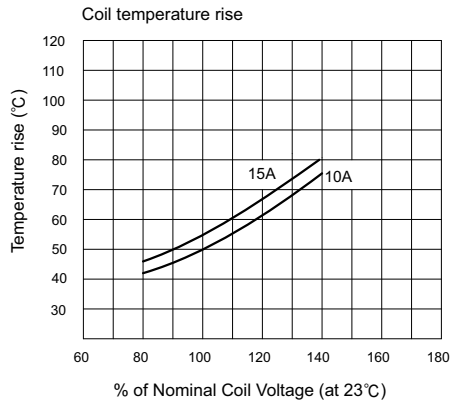

X-ON Electronics

Largest Supplier of Electrical and Electronic Components

Click to view similar products for [General Purpose Relays](#) category:

Click to view products by [Song Chuan](#) manufacturer:

Other Similar products are found below :

[PCN-105D3MH,000](#) [59641F200](#) [5JO-1000CD-SIL](#) [LY1SAC110120](#) [5X827E](#) [5X837F](#) [5X840F](#) [5X842F](#) [5X848E](#) [LY2N-AC120](#) [LY2S-AC220/240](#) [LY2-US-AC120](#) [LY3-US-AC120](#) [LY4F-UA-DC12](#) [LY4F-UA-DC24](#) [LY4F-US-AC120](#) [LY4F-US-AC240](#) [LY4F-US-DC24](#) [LY4F-VD-AC110](#) [LYQ20DC12](#) [M115C60](#) [M115N010](#) [M115N0150](#) [6031007G](#) [603-12D](#) [61211T0B4](#) [61212T400](#) [61222Q400](#) [61243B600](#) [61243C500](#) [61243Q400](#) [61311BOA2](#) [61311BOA6](#) [61311BOA8](#) [61311C0A2](#) [61311COA1](#) [61311COA6](#) [61311F0A2](#) [61311QOA1](#) [61311QOA4](#) [61311T0D6](#) [61311TOA6](#) [61311TOA7](#) [61311TOB3](#) [61311TOB4](#) [61311U0A6](#) [61312Q600](#) [61312T400](#) [61312T600](#) [61313U200](#)