

Negative Temperature Coefficient Thermistor (NTC)

Data Sheet

Feature

■ Wide operating voltage range from $\phi 5$ to $\phi 20$

■ Operating Temperature



| Style | Operating Temperature Range |
|-------------------------------|--|
| $\phi 5$ | $-40^{\circ}\text{C} \sim 155^{\circ}\text{C}$ |
| $\phi 7 / \phi 9 / \phi 11$ | $-40^{\circ}\text{C} \sim 175^{\circ}\text{C}$ |
| $\phi 13 / \phi 15 / \phi 20$ | $-40^{\circ}\text{C} \sim 200^{\circ}\text{C}$ |

■ Storage Temperature: $15^{\circ}\text{C} \sim 35^{\circ}\text{C}$

Applications

■ Suitable for power supply, electronic motors, transformers, adapters, projectors, halogen machines, LED drive circuits, etc.

Applicable Standard

| Approval | Organization | Safety Standards | Certificate No. |
|--|--------------|------------------|-----------------|
| China  | CQC | GB/T 6663.1 | CQC15001128226 |
| USA Canada  | UL | UL 1434 | E474052 |

Part Number Code

| | | | | | | | | | | | |
|----|----|-----|----|---|---|---|----|---|---|---|---|
| MF | 05 | 100 | X8 | M | 3 | B | X7 | C | S | B | 0 |
|----|----|-----|----|---|---|---|----|---|---|---|---|

Songtian
MF:NTC

Zero Power Resistance

0R5:0.5Ω
080:8Ω
100:10Ω
121:120Ω

Tolerance

M:±20%

Pitch

B:5.0mm
E:7.5mm
D:10.0mm

Package

B: Bulk
T: Tape

Inner Management

Encapsulation material
Environmental Standard

S:Silicone+RoHS
P:Phenolic Resin+RoHS
F:Phenolic Resin +Halogen free
R:Phenolic Resin + Halogen free

Core Diameter

05:5mm
20:20mm

Foot Type

1:Long straight
2:Outside Crimped
3:Short Straight
4:Inside kink lead
8:Vertical Crimped

Lead Material

F: Tinned copper clad steel wire
C:Copper wire

Maximum Steady State Current

X1:0.1A
S5:1.5A
03:3.0A
10:10A

Lead Length

S0~S9:1.0~1.9mm
X0~X9:2.0~2.9mm
A0~A9:3.0~3.9mm
B0~B9:4.0~4.9mm
C0~C9:5.0~5.9mm
D0~D9:6.0~6.9mm
E0~E9:7.0~7.9mm

Lead Length

F0~F9:8.0~8.9mm
G0~G9:9.0~9.9mm
H0~H9:10.0~10.9mm
J0~J9:11.0~11.9mm
K0~K9:12.0~12.9mm
L0~L9:13.0~13.9mm
M0~M9:14.0~14.9mm

Lead Length

M0~M9:14.0~14.9mm
N0:16~27.0mm(Bulk)
H0=16.5(Taped)
Taping
PO:17.0mm
Q0:20.0mm

Electrical Characteristics

□ D-5 Series

| Part Number | Rated Zero Power Resistance @25°C (Ω) | Maximum Steady Current @25°C (A) | Residual Resistor At Maximum Steady Current @25°C (Ω) | B Value (K) ±10% | Thermal Time Constant (S) | Heat Dissipation Coefficient (mW/°C) | Operating Temperature Range (°C) |
|-------------|---------------------------------------|----------------------------------|---|------------------|---------------------------|--------------------------------------|----------------------------------|
| 5D-5 | 5 | 1 | 0.353 | 2500 | <20 | >6 | -40°C ~ 155°C |
| 10D-5 | 10 | 0.7 | 0.771 | 2600 | <20 | >6 | -40°C ~ 155°C |
| 15D-5 | 15 | 0.6 | 1.53 | 2600 | <20 | >6 | -40°C ~ 155°C |
| 20D-5 | 20 | 0.5 | 1.253 | 2600 | <20 | >6 | -40°C ~ 155°C |
| 22D-5 | 22 | 0.6 | 2.06 | 2600 | <20 | >6 | -40°C ~ 155°C |
| 30D-5 | 30 | 0.4 | 2.227 | 2600 | <20 | >6 | -40°C ~ 155°C |

| Part Number | Rated Zero Power Resistance @25°C (Ω) | Maximum Steady Current @25°C (A) | Residual Resistor At Maximum Steady Current @25°C (Ω) | B Value (K) ±10% | Thermal Time Constant (S) | Heat Dissipation Coefficient (mW/°C) | Operating Temperature Range (°C) |
|-------------|---------------------------------------|----------------------------------|---|------------------|---------------------------|--------------------------------------|----------------------------------|
| 33D-5 | 33 | 0.4 | 1.324 | 2600 | <20 | >6 | -40°C ~ 155°C |
| 50D-5 | 50 | 0.4 | 2.653 | 2800 | <18 | >6 | -40°C ~ 155°C |
| 60D-5 | 60 | 0.3 | 1.878 | 2800 | <18 | >6 | -40°C ~ 155°C |

□D-7 Series

| Part Number | Rated Zero Power Resistance @25°C (Ω) | Maximum Steady Current @25°C (A) | Residual Resistor At Maximum Steady Current @25°C (Ω) | B Value (K) ±10% | Thermal Time Constant (S) | Heat Dissipation Coefficient (mW/°C) | Operating Temperature Range (°C) |
|-------------|---------------------------------------|----------------------------------|---|------------------|---------------------------|--------------------------------------|----------------------------------|
| 5D-7 | 5 | 2 | 0.283 | 2600 | <30 | >10 | -40°C ~ 175°C |
| 8D-7 | 8 | 1 | 0.539 | 2600 | <28 | >9 | -40°C ~ 175°C |
| 10D-7 | 10 | 1 | 0.616 | 2800 | <27 | >9 | -40°C ~ 175°C |
| 12D-7 | 12 | 1 | 0.816 | 2800 | <27 | >9 | -40°C ~ 175°C |
| 16D-7 | 16 | 0.7 | 1.003 | 2800 | <27 | >9 | -40°C ~ 175°C |
| 20D-7 | 20 | 0.6 | 1.102 | 2800 | <27 | >9 | -40°C ~ 175°C |
| 22D-7 | 22 | 0.6 | 1.108 | 2800 | <27 | >9 | -40°C ~ 175°C |
| 30D-7 | 30 | 0.5 | 3.7059 | 2800 | <28 | >10 | -40°C ~ 175°C |
| 33D-7 | 33 | 0.2 | 1.485 | 2800 | <28 | >10 | -40°C ~ 175°C |
| 50D-7 | 50 | 0.5 | 1.653 | 2800 | <28 | >10 | -40°C ~ 175°C |

□D-9 Series

| Part Number | Rated Zero Power Resistance @25°C (Ω) | Maximum Steady Current @25°C (A) | Residual Resistor At Maximum Steady Current @25°C (Ω) | B Value (K) ±10% | Thermal Time Constant (S) | Heat Dissipation Coefficient (mW/°C) | Operating Temperature Range (°C) |
|-------------|---------------------------------------|----------------------------------|---|------------------|---------------------------|--------------------------------------|----------------------------------|
| 3D-9 | 3 | 4 | 0.120 | 2600 | <35 | >11 | -40°C ~ 175°C |
| 4D-9 | 4 | 3 | 0.190 | 2600 | <35 | >11 | -40°C ~ 175°C |
| 5D-9 | 5 | 3 | 0.210 | 2600 | <34 | >11 | -40°C ~ 175°C |
| 6D-9 | 6 | 2 | 0.315 | 2600 | <34 | >11 | -40°C ~ 175°C |
| 7D-9 | 7 | 2 | 0.3265 | 2800 | <34 | >11 | -40°C ~ 175°C |
| 8D-9 | 8 | 2 | 0.400 | 2800 | <32 | >11 | -40°C ~ 175°C |
| 10D-9 | 10 | 2 | 0.458 | 2800 | <32 | >11 | -40°C ~ 175°C |
| 12D-9 | 12 | 1 | 0.652 | 2800 | <32 | >11 | -40°C ~ 175°C |
| 16D-9 | 16 | 1 | 0.802 | 2800 | <31 | >11 | -40°C ~ 175°C |

| Part Number | Rated Zero Power Resistance @25°C (Ω) | Maximum Steady Current @25°C (A) | Residual Resistor At Maximum Steady Current @25°C (Ω) | B Value (K) ±10% | Thermal Time Constant (S) | Heat Dissipation Coefficient (mW/°C) | Operating Temperature Range (°C) |
|-------------|---------------------------------------|----------------------------------|---|------------------|---------------------------|--------------------------------------|----------------------------------|
| 20D-9 | 20 | 1 | 0.864 | 3000 | <30 | >11 | -40°C ~ 175°C |
| 22D-9 | 22 | 1 | 0.950 | 3000 | <30 | >11 | -40°C ~ 175°C |
| 30D-9 | 30 | 1 | 1.022 | 3000 | <30 | >11 | -40°C ~ 175°C |
| 33D-9 | 33 | 1 | 1.124 | 3000 | <30 | >11 | -40°C ~ 175°C |
| 50D-9 | 50 | 1 | 1.252 | 3200 | <30 | >11 | -40°C ~ 175°C |
| 60D-9 | 60 | 0.8 | 1.502 | 3200 | <31 | >11 | -40°C ~ 175°C |
| 80D-9 | 80 | 0.8 | 2.010 | 3200 | <30 | >11 | -40°C ~ 175°C |
| 120D-9 | 120 | 0.8 | 3.015 | 3200 | <30 | >11 | -40°C ~ 175°C |
| 200D-9 | 200 | 0.5 | 5.007 | 3400 | <32 | >11 | -40°C ~ 175°C |

□D-11 Series

| Part Number | Rated Zero Power Resistance @25°C (Ω) | Maximum Steady Current @25°C (A) | Residual Resistor At Maximum Steady Current @25°C (Ω) | B Value (K) ±10% | Thermal Time Constant (S) | Heat Dissipation Coefficient (mW/°C) | Operating Temperature Range (°C) |
|-------------|---------------------------------------|----------------------------------|---|------------------|---------------------------|--------------------------------------|----------------------------------|
| 2.5D-11 | 2.5 | 5 | 0.095 | 2600 | <43 | >13 | -40°C ~ 175°C |
| 3D-11 | 3 | 5 | 0.100 | 2600 | <43 | >13 | -40°C ~ 175°C |
| 4D-11 | 4 | 4 | 0.150 | 2600 | <44 | >13 | -40°C ~ 175°C |
| 5D-11 | 5 | 4 | 0.156 | 2800 | <45 | >13 | -40°C ~ 175°C |
| 6D-11 | 6 | 3 | 0.240 | 2800 | <45 | >13 | -40°C ~ 175°C |
| 7D-11 | 7 | 3 | 0.2824 | 2800 | <45 | >13 | -40°C ~ 175°C |
| 8D-11 | 8 | 3 | 0.255 | 2800 | <47 | >14 | -40°C ~ 175°C |
| 10D-11 | 10 | 3 | 0.275 | 2800 | <47 | >14 | -40°C ~ 175°C |
| 12D-11 | 12 | 2 | 0.462 | 2800 | <48 | >14 | -40°C ~ 175°C |
| 15D-11 | 15 | 2 | 0.468 | 2800 | <50 | >14 | -40°C ~ 175°C |
| 16D-11 | 16 | 2 | 0.470 | 2800 | <50 | >14 | -40°C ~ 175°C |
| 20D-11 | 20 | 2 | 0.512 | 3000 | <52 | >15 | -40°C ~ 175°C |
| 22D-11 | 22 | 2 | 0.563 | 3000 | <52 | >15 | -40°C ~ 175°C |
| 25D-11 | 25 | 2 | 0.623 | 3000 | <52 | >15 | -40°C ~ 175°C |
| 30D-11 | 30 | 1.5 | 0.667 | 3000 | <52 | >15 | -40°C ~ 175°C |
| 33D-11 | 33 | 1.5 | 0.734 | 3000 | <52 | >15 | -40°C ~ 175°C |
| 47D-11 | 47 | 1.5 | 1.002 | 3200 | <52 | >15 | -40°C ~ 175°C |
| 50D-11 | 50 | 1.5 | 1.021 | 3200 | <52 | >15 | -40°C ~ 175°C |

| Part Number | Rated Zero Power Resistance @25°C (Ω) | Maximum Steady Current @25°C (A) | Residual Resistor At Maximum Steady Current @25°C (Ω) | B Value (K) ±10% | Thermal Time Constant (S) | Heat Dissipation Coefficient (mW/°C) | Operating Temperature Range (°C) |
|-------------|---------------------------------------|----------------------------------|---|------------------|---------------------------|--------------------------------------|----------------------------------|
| 60D-11 | 60 | 1.5 | 1.215 | 3200 | <52 | >15 | -40°C ~ 175°C |
| 80D-11 | 80 | 1.2 | 1.656 | 3200 | <52 | >15 | -40°C ~ 175°C |
| 120D-11 | 120 | 1.1 | 2.253 | 3000 | <50 | >15 | -40°C ~ 175°C |

□D-13 Series

| Part Number | Rated Zero Power Resistance @25°C (Ω) | Maximum Steady Current @25°C (A) | Residual Resistor At Maximum Steady Current @25°C (Ω) | B Value (K) ±10% | Thermal Time Constant (S) | Heat Dissipation Coefficient (mW/°C) | Operating Temperature Range (°C) |
|-------------|---------------------------------------|----------------------------------|---|------------------|---------------------------|--------------------------------------|----------------------------------|
| 1.3D-13 | 1.3 | 7 | 0.062 | 2600 | <60 | >13 | -40°C ~ 200°C |
| 1.5D-13 | 1.5 | 7 | 0.073 | 2600 | <60 | >13 | -40°C ~ 200°C |
| 2.5D-13 | 2.5 | 6 | 0.088 | 2600 | <60 | >13 | -40°C ~ 200°C |
| 3D-13 | 3 | 6 | 0.092 | 2600 | <60 | >14 | -40°C ~ 200°C |
| 4D-13 | 4 | 5 | 0.120 | 2800 | <67 | >15 | -40°C ~ 200°C |
| 4.7D-13 | 4.7 | 5 | 0.1469 | 2800 | <67 | >15 | -40°C ~ 200°C |
| 5D-13 | 5 | 5 | 0.125 | 2800 | <68 | >15 | -40°C ~ 200°C |
| 6D-13 | 6 | 4 | 0.170 | 2800 | <65 | >15 | -40°C ~ 200°C |
| 7D-13 | 7 | 4 | 0.188 | 3000 | <65 | >15 | -40°C ~ 200°C |
| 8D-13 | 8 | 4 | 0.194 | 3000 | <60 | >15 | -40°C ~ 200°C |
| 10D-13 | 10 | 4 | 0.206 | 3000 | <65 | >15 | -40°C ~ 200°C |
| 12D-13 | 12 | 3 | 0.316 | 3200 | <65 | >16 | -40°C ~ 200°C |
| 15D-13 | 15 | 3 | 0.335 | 3200 | <60 | >16 | -40°C ~ 200°C |
| 16D-13 | 16 | 3 | 0.338 | 3200 | <60 | >16 | -40°C ~ 200°C |
| 18D-13 | 18 | 3 | 0.356 | 3200 | <60 | >16 | -40°C ~ 200°C |
| 20D-13 | 20 | 3 | 0.372 | 3200 | <65 | >16 | -40°C ~ 200°C |
| 22D-13 | 22 | 3 | 0.625 | 3200 | <65 | >16 | -40°C ~ 200°C |
| 25D-13 | 25 | 2.5 | 0.422 | 3200 | <65 | >16 | -40°C ~ 200°C |
| 30D-13 | 30 | 2.5 | 0.517 | 3200 | <65 | >16 | -40°C ~ 200°C |
| 33D-13 | 33 | 2.5 | 0.592 | 3200 | <65 | >16 | -40°C ~ 200°C |
| 47D-13 | 47 | 2 | 0.810 | 3200 | <65 | >17 | -40°C ~ 200°C |
| 50D-13 | 50 | 2 | 1.161 | 3200 | <65 | >13 | -40°C ~ 200°C |
| 120D-13 | 120 | 1.2 | 2.124 | 3400 | <65 | >17 | -40°C ~ 200°C |

□D-15 Series

| Part Number | Rated Zero Power Resistance @25°C (Ω) | Maximum Steady Current @25°C (A) | Residual Resistor At Maximum Steady Current @25°C (Ω) | B Value (K) ±10% | Thermal Time Constant (S) | Heat Dissipation Coefficient (mW/°C) | Operating Temperature Range (°C) |
|-------------|---------------------------------------|----------------------------------|---|------------------|---------------------------|--------------------------------------|----------------------------------|
| 1.3D-15 | 1.3 | 8 | 0.048 | 2600 | <68 | >18 | -40°C~200°C |
| 1.5D-15 | 1.5 | 8 | 0.052 | 2600 | <69 | >18 | -40°C~200°C |
| 2.5D-15 | 2.5 | 7 | 0.065 | 2800 | <76 | >18 | -40°C~200°C |
| 3D-15 | 3 | 7 | 0.075 | 2800 | <76 | >18 | -40°C~200°C |
| 4D-15 | 4 | 6 | 0.1985 | 2800 | <76 | >18 | -40°C~200°C |
| 5D-15 | 5 | 6 | 0.112 | 3000 | <76 | >20 | -40°C~200°C |
| 6D-15 | 6 | 5 | 0.155 | 3000 | <80 | >20 | -40°C~200°C |
| 7D-15 | 7 | 5 | 0.173 | 3000 | <80 | >20 | -40°C~200°C |
| 8D-15 | 8 | 5 | 0.178 | 3000 | <80 | >20 | -40°C~200°C |
| 10D-15 | 10 | 5 | 0.180 | 3200 | <75 | >20 | -40°C~200°C |
| 12D-15 | 12 | 4 | 0.250 | 3200 | <75 | >20 | -40°C~200°C |
| 15D-15 | 15 | 4 | 0.268 | 3200 | <85 | >21 | -40°C~200°C |
| 16D-15 | 16 | 4 | 0.276 | 3200 | <70 | >21 | -40°C~200°C |
| 18D-15 | 18 | 4 | 0.3375 | 3200 | <70 | >21 | -40°C~200°C |
| 20D-15 | 20 | 4 | 0.288 | 3200 | <86 | >21 | -40°C~200°C |
| 22D-15 | 22 | 4 | 0.3812 | 3200 | <86 | >21 | -40°C~200°C |
| 25D-15 | 25 | 3.5 | 0.358 | 3200 | <86 | >21 | -40°C~200°C |
| 30D-15 | 30 | 3.5 | 0.438 | 3200 | <75 | >21 | -40°C~200°C |
| 33D-15 | 33 | 3 | 0.571 | 3200 | <86 | >21 | -40°C~200°C |
| 40D-15 | 40 | 3 | 0.587 | 3200 | <86 | >21 | -40°C~200°C |
| 47D-15 | 47 | 3 | 0.680 | 3200 | <86 | >21 | -40°C~200°C |
| 50D-15 | 50 | 3 | 0.734 | 3200 | <86 | >21 | -40°C~200°C |
| 120D-15 | 120 | 1.8 | 1.652 | 3400 | <87 | >22 | -40°C~200°C |

□D-20 Series

| Part Number | Rated Zero Power Resistance @25°C (Ω) | Maximum Steady Current @25°C (A) | Residual Resistor At Maximum Steady Current @25°C (Ω) | B Value (K) ±10% | Thermal Time Constant (S) | Heat Dissipation Coefficient (mW/°C) | Operating Temperature Range (°C) |
|-------------|---------------------------------------|----------------------------------|---|------------------|---------------------------|--------------------------------------|----------------------------------|
| 0.7D-20 | 0.7 | 11 | 0.018 | 2400 | <89 | >24 | -40°C~200°C |
| 1.3D-20 | 1.3 | 9 | 0.037 | 2600 | <88 | >24 | -40°C~200°C |

| Part Number | Rated Zero Power Resistance @25°C (Ω) | Maximum Steady Current @25°C (A) | Residual Resistor At Maximum Steady Current @25°C (Ω) | B Value (K) ±10% | Thermal Time Constant (S) | Heat Dissipation Coefficient (mW/°C) | Operating Temperature Range (°C) |
|-------------|---------------------------------------|----------------------------------|---|------------------|---------------------------|--------------------------------------|----------------------------------|
| 2.2D-20 | 2.2 | 8 | 0.1292 | 2800 | <88 | >24 | -40°C ~ 200°C |
| 2.5D-20 | 2.5 | 8 | 0.052 | 2800 | <88 | >24 | -40°C ~ 200°C |
| 3D-20 | 3 | 8 | 0.055 | 2800 | <88 | >24 | -40°C ~ 200°C |
| 5D-20 | 5 | 7 | 0.087 | 3000 | <87 | >24 | -40°C ~ 200°C |
| 6D-20 | 6 | 6 | 0.113 | 3000 | <103 | >25 | -40°C ~ 200°C |
| 8D-20 | 8 | 6 | 0.142 | 3000 | <105 | >25 | -40°C ~ 200°C |
| 10D-20 | 10 | 6 | 0.162 | 3200 | <102 | >25 | -40°C ~ 200°C |
| 12D-20 | 12 | 5 | 0.195 | 3200 | <100 | >25 | -40°C ~ 200°C |
| 16D-20 | 16 | 5 | 0.212 | 3200 | <100 | >25 | -40°C ~ 200°C |

Dimensions (mm) and Approval

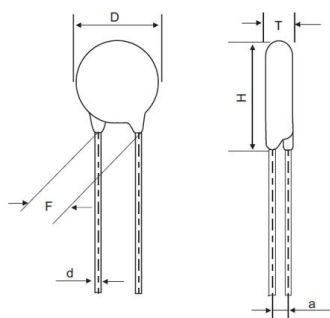

| Part No. | Size (mm) | | | | | Approval | |
|----------|-----------|--------|-------|--------|-----|----------|--------------|
| | D Max. | T Max. | F±0.8 | d±0.05 | | CQC | cUL (Canada) |
| | | | | CP | CU | | |
| □D-5 | 7.0 | 4.5 | 5.0 | 0.6 | 0.6 | √ | √ |
| □D-7 | 9.0 | 5.0 | 5.0 | 0.6 | 0.6 | √ | √ |
| □D-9 | 11.0 | 6.0 | 5.0 | 0.7 | 0.8 | √ | √ |
| □D-11 | 13.0 | 6.5 | 7.5 | 0.7 | 0.8 | √ | √ |
| □D-13 | 15.5 | 7.0 | 7.5 | 0.7 | 0.8 | √ | √ |
| □D-15 | 17.5 | 7.0 | 7.5 | 0.7 | 0.8 | √ | √ |
| □D-20 | 22.5 | 7.0 | 10.0 | 1.0 | 1.0 | √ | √ |

Lead Configuration

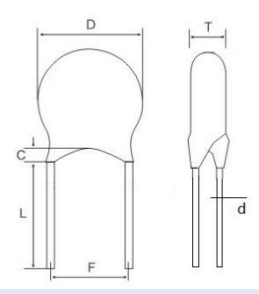
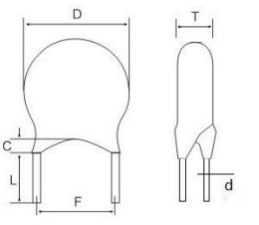
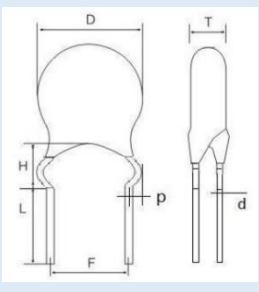
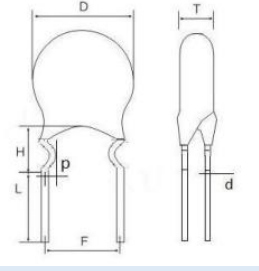
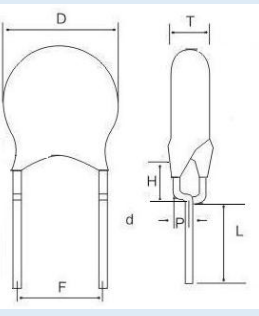
| Lead Style | Drawing | Lead Length L (mm) | Coating Lead Length C (mm) | Height H (mm) |
|------------------|---|--------------------------------------|----------------------------|---------------|
| Long Straight |  | 16.0 min | 3.0 Max | / |
| Short Straight |  | ①[2.5≤L<6.0]±0.5; ②[6.0≤L≤10]±1.0 | 3.0 Max | / |
| Outside Crimped |  | ①[2.5≤L<6.0]±0.5; ②[6.0≤L≤10]±1.0 | Not exceed the bend point | 5.0mm Max |
| Inner Crimped |  | ①[2.5≤L<6.0]±0.5; ②[6.0≤L≤10]±1.0 | Not exceed the bend point | 6.0mm Max |
| Vertical Crimped |  | ①[2.5≤L<6.0]±0.5; ②[6.0≤L≤10]±1.0 | Not exceed the bend point | 4.0mm Max |

Taping Specification (mm)

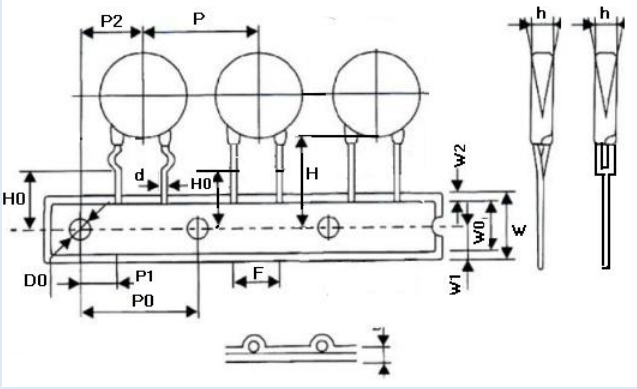
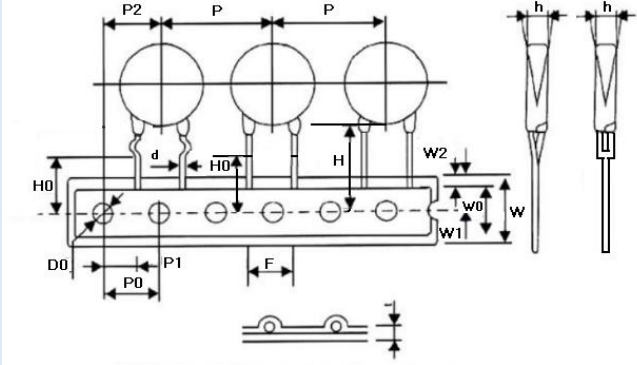
| Figure | Fig.1 | | Fig.2 | | | | |
|---|--|---------------|------------------------|------------------------|------------------------|--------------|---------------|
| | Symbol | P=5.0 | P=7.5 | | P=10.0 | | |
|  <p>Fig.1 (P=5.0)</p> | Po | 12.7±0.3 | 12.7±0.3 | 12.7±0.3 | | | |
| | P | 12.7±1.0 | 25.4±1.0 | 25.4±1.0 | | | |
| | P1 | 3.85±0.7 | 8.95±0.7 | 7.7±0.7 | | | |
| | P2 | 6.35±1.3 | 12.7±1.3 | 12.7±1.3 | | | |
| | F | 5±0.8 | 7.5±0.8 | 10.0±0.8 | | | |
| | Δh | 0±2.0 | 0±2.0 | 0±2.0 | | | |
| | W | 18.0+1.5/-1.0 | 18.0 +1.5/-1.0 | 18.0 +1.5/-1.0 | | | |
| | Wo | 10.5 Max | 10.5 Max | 10.5 Max | | | |
| | W1 | 9.0+0.75/-0.5 | 9.0+0.75/-0.5 | 9.0+0.75/-0.5 | | | |
| | W2 | 3.0 Max | 3.0 Max | 3.0 Max | | | |
| | Do | 4.0±0.2 | 4.0±0.2 | 4.0±0.2 | | | |
| |  <p>Fig.2 (P=7.5 & 10)</p> | H | 20+1.5/-1.0 | 20+1.5/-1.0 | 20+1.5/-1.0 | | |
| | | Ho | 16.5&17.0 +1.5/-1.0 | 16.5&17.0 +1.5/-1.0 | 16.5&17.0 +1.5/-1.0 | | |
| | | L | Straight Lead | Crimped Lead | Straight Lead | Crimped Lead | Straight Lead |
| 11.0 Max | | | 9.0 Max | 11.0 Max | 9.0 Max | 11.0 Max | 9.0 Max |
| t1 | | 0.5±0.2 | 0.5±0.2 | 0.5±0.2 | | | |
| t2 | | 1.7 Max | 1.7 Max | 1.7 Max | | | |

X-ON Electronics

Largest Supplier of Electrical and Electronic Components

Click to view similar products for [NTC \(Negative Temperature Coefficient\) Thermistors](#) *category:*

Click to view products by [Songtian](#) *manufacturer:*

Other Similar products are found below :

[B57364S2509A002](#) [526-31AA19-104](#) [526-31AN12-202](#) [11028414-00](#) [526-31AA79-102](#) [PTCLL05P131TBE](#) [144-101FAG-001](#) [521-53AW02-104](#) [1-1423022-3](#) [MF0916001M4BP0FPT0](#) [MF58-5.91KF3820-B1](#) [04M5002SFA4](#) [NCG18WF104F0SRB](#)
[NXFT15WF104FEAB035](#) [NXFT15WF104FEAB040](#) [NXFT15XV103FEAB030](#) [NXFT15XV103FEAB025](#) [NXFT15XV103FEAB040](#)
[NXFT15XH103FEAB050](#) [NXFT15XH103FEAB040](#) [NCG18XH103F0SRB](#) [USUR1000-502G-06](#) [NXFT15XH103FEAB045](#)
[B57864S0502F040](#) [NTCALUG01A103G611](#) [GA50K6A1IA](#) [GA10K3MR1I](#) [NXFT15XV103FEAB035](#) [NXFT15XV103FEAB021](#)
[NXFT15XV103FEAB045](#) [GA50K6A1IB](#) [GA30K5A1A](#) [GA10K4A1IA](#) [A1004SS22P63](#) [11031964-00](#) [NXFT15XH103FEAB035](#)
[NXFT15WF104FEAB021](#) [GA100K6A1IB](#) [11026149-00](#) [TCTR0805F10K0F4460T](#) [TCTR0805F10K0F3720T](#) [TCTR0603F100KF4460T](#)
[TCTR0603F100KF4390T](#) [TCTR0603F100KF4050T](#) [TCTR0603F100KF3980T](#) [TCTR0603F10K0F4300T](#) [TCTR0603F10K0F3960T](#)
[TCTR0603F10K0F3930T](#) [TCTR0805F100KF4460T](#) [TCTR0805F100KF4310T](#)