

压敏电阻器-S 系列(标准品)规格书

特点

- 电阻器工作电压范围从 18V 到 1100V。
- 工作温度： -40℃~ +105℃
- 储存温度： 15℃~35℃

用途

- 晶体管，IC，可控硅和半导体开关元件以及各种电子，电器设备的过压保护。
- 家用电器的浪涌吸收和过压保护。
- 工业电器浪涌吸收。
- 静电放电和噪音信号消除。
- 继电器和电磁阀的浪涌吸收。
- 漏电开关的过电压保护。
- 电话机程控交换机及通讯设备的防雷及过压保护。

安规认证

国家		认证组织	标准号	证书号
中国		CQC	GB/T10193 GB/T10194	5D: CQC07001020534
				7D: CQC07001020533
				10D: CQC07001020532
				14D: CQC07001020531
				20D: CQC07001020530
美国/加拿大		UL	UL1449	E330837
德国		VDE	IEC61051	40023049

料号编码原则

内部管理码

STE	10	D	471	K	1	E	N0	F	S	B	0	R	0
-----	----	---	-----	---	---	---	----	---	---	---	---	---	---

类别
(STE)

产品外形
D: 圆形

精度
K:±10%

脚距
B:5.0mm
E:7.5mm
D:10.0mm

包装方式
B: 散件
T: 编带

环保类型
R: RoHS
F: RoHS+无卤

芯片直径
05:5mm
07:7mm
10:10mm
14:14mm
20:20mm

脚型
1 长直脚型
2:单外弯脚型
3:短直脚型
8:前后翘脚型

压敏电阻器类型
S: 标准品

引线材料
F: 镀锡铜包钢线
C:铜线

标称压敏电压
220:22V
471:470V
122:1200V

脚长	脚长	脚长
S0~S9:1.0~1.9mm	F0~F9:8.0~8.9mm	M0~M9:14.0~14.9mm
X0~X9:2.0~2.9mm	G0~G9:9.0~9.9mm	N0:16~27.0mm(散件)
A0~A9:3.0~3.9mm	H0~H9:10.0~10.9mm	N0:H0=16.5(编带)
B0~B9:4.0~4.9mm	J0~J9:11.0~11.9mm	编带
C0~C9:5.0~5.9mm	K0~K9:12.0~12.9mm	P0:17.0mm (弯脚)
D0~D9:6.0~6.9mm	L0~L9:13.0~13.9mm	Q0:19.0mm (弯脚)
E0~E9:7.0~7.9mm	M0~M9:14.0~14.9mm	Q0:20.0mm (直脚)

基本特性

5D-S 系列

规格	最大连续工作电压		压敏电压 $V_{0.1mA}$ (V)	最大限制电压		最大峰值电流 (8/20 μ s)		最大能量 (10/1000 μ s) (J)	额定功率 (W)	静电容量 (参考值) 1KHz (pF)
	AC _{rms} (V)	DC _{rms} (V)		VC (V)	IP (A)	1 pulse (A)	2 pulse (A)			
STE-05D180KS	11	14	18(15-21.6)	40	1	100	50	0.4	0.01	1400
STE-05D220KS	14	18	22(19.5-26)	48	1	100	50	0.5	0.01	1150
STE-05D270KS	17	22	27(24-31)	60	1	100	50	0.6	0.01	930
STE-05D330KS	20	26	33(29.5-36.5)	73	1	100	50	0.8	0.01	760
STE-05D390KS	25	31	39(35-43)	80	1	100	50	0.9	0.01	640
STE-05D470KS	30	38	47(42-52)	104	1	100	50	1.1	0.01	530
STE-05D560KS	35	45	56(50-62)	123	1	100	50	1.3	0.01	450
STE-05D680KS	40	56	68(61-75)	145	1	100	50	1.6	0.01	370
STE-05D820KS	50	65	82(74-90)	150	5	400	200	2.5	0.1	300
STE-05D101KS	60	85	100(90-110)	175	5	400	200	3.0	0.1	250
STE-05D121KS	75	100	120(108-132)	210	5	400	200	3.5	0.1	210
STE-05D151KS	95	125	150(135-165)	260	5	400	200	4.5	0.1	165
STE-05D181KS	115	150	180(162-198)	320	5	400	200	5.9	0.1	140
STE-05D201KS	130	170	200(180-220)	355	5	400	200	6.5	0.1	125
STE-05D221KS	140	180	220(198-242)	380	5	400	200	7.0	0.1	110
STE-05D241KS	150	200	240(216-264)	415	5	400	200	8.0	0.1	100
STE-05D271KS	175	225	270(243-297)	475	5	400	200	8.5	0.1	95
STE-05D301KS	190	250	300(270-330)	520	5	400	200	9.0	0.1	85
STE-05D331KS	210	275	330(297-363)	570	5	400	200	9.5	0.1	75
STE-05D361KS	230	300	360(324-396)	620	5	400	200	10.0	0.1	70
STE-05D391KS	250	320	390(351-429)	675	5	400	200	12.0	0.1	65
STE-05D431KS	275	350	430(387-473)	745	5	400	200	13.0	0.1	60
STE-05D471KS	300	385	470(423-517)	810	5	400	200	15.0	0.1	55
STE-05D511KS	320	415	510(459-561)	845	5	400	200	16.0	0.1	50
STE-05D561KS	350	460	560(504-616)	920	5	400	200	16.8	0.1	45
STE-05D621KS	385	505	620(558-682)	1025	5	400	200	17.7	0.1	40
STE-05D681KS	420	560	680(612-748)	1120	5	400	200	19.4	0.1	38

7D-S 系列

规格	最大连续 工作电压		压敏电压 V_{1mA} (V)	最大 限制电压		最大峰值电流 (8/20 μ s)		最大能量 (10/1000 μ s) (J)	额定 功率 (W)	静电容量 (参考值) 1KHz (pF)
	AC _{rms} (V)	DC _{rms} (V)		VC (V)	IP (A)	1 pulse (A)	2 pulse (A)			
STE-07D180KS	11	14	18(15-21.6)	36	2.5	250	125	0.9	0.02	2800
STE-07D220KS	14	18	22(19.5-26)	43	2.5	250	125	1.1	0.02	2300
STE-07D270KS	17	22	27(24-31)	53	2.5	250	125	1.4	0.02	1800
STE-07D330KS	20	26	33(29.5-36.5)	65	2.5	250	125	1.7	0.02	1500
STE-07D390KS	25	31	39(35-43)	77	2.5	250	125	2.1	0.02	1300
STE-07D470KS	30	38	47(42-52)	93	2.5	250	125	2.5	0.02	1100
STE-07D560KS	35	45	56(50-62)	110	2.5	250	125	3.1	0.02	890
STE-07D680KS	40	56	68(61-75)	135	2.5	250	125	3.6	0.02	740
STE-07D820KS	50	65	82(74-90)	135	10	1200	600	5.5	0.25	810
STE-07D101KS	60	85	100(90-110)	165	10	1200	600	6.5	0.25	700
STE-07D121KS	75	100	120(108-132)	200	10	1200	600	7.8	0.25	590
STE-07D151KS	95	125	150(135-165)	250	10	1200	600	9.7	0.25	500
STE-07D181KS	115	150	180(162-198)	300	10	1200	600	11.7	0.25	280
STE-07D201KS	130	170	200(180-220)	340	10	1200	600	13.0	0.25	200
STE-07D221KS	140	180	220(198-242)	360	10	1200	600	14.0	0.25	190
STE-07D241KS	150	200	240(216-264)	395	10	1200	600	15.0	0.25	170
STE-07D271KS	175	225	270(243-297)	455	10	1200	600	18.0	0.25	150
STE-07D301KS	190	250	300(270-330)	500	10	1200	600	20.0	0.25	140
STE-07D331KS	210	275	330(297-363)	550	10	1200	600	23.0	0.25	130
STE-07D361KS	230	300	360(324-396)	595	10	1200	600	24.0	0.25	130
STE-07D391KS	250	320	390(351-429)	650	10	1200	600	26.0	0.25	130
STE-07D431KS	275	350	430(387-473)	710	10	1200	600	28.0	0.25	120
STE-07D471KS	300	385	470(423-517)	775	10	1200	600	29.0	0.25	100
STE-07D511KS	320	415	510(459-561)	845	10	1200	600	31.0	0.25	90
STE-07D561KS	350	460	560(504-616)	925	10	1200	600	35.0	0.25	90
STE-07D621KS	385	505	620(558-682)	1025	10	1200	600	38.0	0.25	80
STE-07D681KS	420	560	680(612-748)	1120	10	1200	600	42.0	0.25	75

10D-S 系列

规格	最大连续工作电压		压敏电压 V _{1mA} (V)	最大限制电压		最大峰值电流 (8/20μs)		最大能量 (10/1000μs) (J)	额定功率 (W)	静电容量 (参考值) 1KHz (pF)
	AC _{rms} (V)	DC _{rms} (V)		VC (V)	IP (A)	1 pulse (A)	2 pulse (A)			
STE-10D180KS	11	14	18(15-21.6)	36	5	500	250	2.1	0.05	5600
STE-10D220KS	14	18	22(19.5-26)	43	5	500	250	2.5	0.05	4500
STE-10D270KS	17	22	27(24-31)	53	5	500	250	3.0	0.05	3700
STE-10D330KS	20	26	33(29.5-36.5)	65	5	500	250	4.0	0.05	3000
STE-10D390KS	25	31	39(35-43)	77	5	500	250	4.6	0.05	2400
STE-10D470KS	30	38	47(42-52)	93	5	500	250	5.5	0.05	2100
STE-10D560KS	35	45	56(50-62)	110	5	500	250	7.0	0.05	1800
STE-10D680KS	40	56	68(61-75)	135	5	500	250	8.2	0.05	1500
STE-10D820KS	50	65	82(74-90)	135	25	2500	1250	12.0	0.4	2000
STE-10D101KS	60	85	100(90-110)	165	25	2500	1250	15.0	0.4	1700
STE-10D121KS	75	100	120(108-132)	200	25	2500	1250	18.0	0.4	1400
STE-10D151KS	95	125	150(135-165)	250	25	2500	1250	22.0	0.4	1100
STE-10D181KS	115	150	180(162-198)	300	25	2500	1250	27.0	0.4	560
STE-10D201KS	130	170	200(180-220)	340	25	2500	1250	30.0	0.4	430
STE-10D221KS	140	180	220(198-242)	360	25	2500	1250	32.0	0.4	410
STE-10D241KS	150	200	240(216-264)	395	25	2500	1250	35.0	0.4	380
STE-10D271KS	175	225	270(243-297)	455	25	2500	1250	37.0	0.4	350
STE-10D301KS	190	250	300(270-330)	500	25	2500	1250	40.0	0.4	330
STE-10D331KS	210	275	330(297-363)	550	25	2500	1250	43.0	0.4	300
STE-10D361KS	230	300	360(324-396)	595	25	2500	1250	47.0	0.4	300
STE-10D391KS	250	320	390(351-429)	650	25	2500	1250	60.0	0.4	300
STE-10D431KS	275	350	430(387-473)	710	25	2500	1250	65.0	0.4	270
STE-10D471KS	300	385	470(423-517)	775	25	2500	1250	67.0	0.4	230
STE-10D511KS	320	415	510(459-561)	845	25	2500	1250	69.0	0.4	210
STE-10D561KS	350	460	560(504-616)	925	25	2500	1250	70.0	0.4	180
STE-10D621KS	385	505	620(558-682)	1025	25	2500	1250	72.0	0.4	190
STE-10D681KS	420	560	680(612-748)	1120	25	2500	1250	75.0	0.4	170
STE-10D751KS	460	615	750(675-825)	1240	25	2500	1250	77.0	0.4	160
STE-10D781KS	485	640	780(702-858)	1290	25	2500	1250	80.0	0.4	125
STE-10D821KS	510	670	820(738-902)	1355	25	2500	1250	85.0	0.4	140
STE-10D911KS	550	745	910(819-1001)	1500	25	2500	1250	93.0	0.4	120
STE-10D102KS	625	825	1000(900-1100)	1650	25	2500	1250	102.0	0.4	110
STE-10D112KS	680	895	1100(990-1210)	1815	25	2500	1250	115.0	0.4	90

14D-S 系列

规格	最大连续工作电压		压敏电压 V _{1mA} (V)	最大限制电压		最大峰值电流 (8/20μs)		最大能量 (10/1000μs) (J)	额定功率 (W)	静电容量 (参考值) 1KHz (pF)
	AC _{rms} (V)	DC _{rms} (V)		VC (V)	IP (A)	1 pulse (A)	2 pulse (A)			
STE-14D180KS	11	14	18(15-21.6)	36	10	1000	500	4.0	0.1	11100
STE-14D220KS	14	18	22(19.5-26)	43	10	1000	500	5.0	0.1	9100
STE-14D270KS	17	22	27(24-31)	53	10	1000	500	6.0	0.1	7400
STE-14D330KS	20	26	33(29.5-36.5)	65	10	1000	500	7.5	0.1	6100
STE-14D390KS	25	31	39(35-43)	77	10	1000	500	8.6	0.1	5100
STE-14D470KS	30	38	47(42-52)	93	10	1000	500	10.0	0.1	4300
STE-14D560KS	35	45	56(50-62)	110	10	1000	500	11.0	0.1	3600
STE-14D680KS	40	56	68(61-75)	135	10	1000	500	14.0	0.1	2900
STE-14D820KS	50	65	82(74-90)	135	50	4500	2500	22.0	0.6	3700
STE-14D101KS	60	85	100(90-110)	165	50	4500	2500	28.0	0.6	3200
STE-14D121KS	75	100	120(108-132)	200	50	4500	2500	32.0	0.6	2700
STE-14D151KS	95	125	150(135-165)	250	50	4500	2500	40.0	0.6	2200
STE-14D181KS	115	150	180(162-198)	300	50	4500	2500	50.0	0.6	1100
STE-14D201KS	130	170	200(180-220)	340	50	4500	2500	57.0	0.6	770
STE-14D221KS	140	180	220(198-242)	360	50	4500	2500	60.0	0.6	740
STE-14D241KS	150	200	240(216-264)	395	50	4500	2500	63.0	0.6	700
STE-14D271KS	175	225	270(243-297)	455	50	4500	2500	70.0	0.6	640
STE-14D301KS	190	250	300(270-330)	500	50	4500	2500	77.0	0.6	670
STE-14D331KS	210	275	330(297-363)	550	50	4500	2500	85.0	0.6	580
STE-14D361KS	230	300	360(324-396)	595	50	4500	2500	93.0	0.6	540
STE-14D391KS	250	320	390(351-429)	650	50	4500	2500	100	0.6	500
STE-14D431KS	275	350	430(387-473)	710	50	4500	2500	115	0.6	450
STE-14D471KS	300	385	470(423-517)	775	50	4500	2500	118	0.6	400
STE-14D511KS	320	415	510(459-561)	845	50	4500	2500	121	0.6	350
STE-14D561KS	350	460	560(504-616)	925	50	4500	2500	125	0.6	360
STE-14D621KS	385	505	620(558-682)	1025	50	4500	2500	128	0.6	330
STE-14D681KS	420	560	680(612-748)	1120	50	4500	2500	130	0.6	320
STE-14D751KS	460	615	750(675-825)	1240	50	4500	2500	143	0.6	310
STE-14D781KS	485	640	780(702-858)	1290	50	4500	2500	148	0.6	260
STE-14D821KS	510	670	820(738-902)	1355	50	4500	2500	157	0.6	280
STE-14D911KS	550	745	910(819-1001)	1500	50	4500	2500	175	0.6	250
STE-14D102KS	625	825	1000(900-1100)	1650	50	4500	2500	190	0.6	230
STE-14D112KS	680	895	1100(990-1210)	1815	50	4500	2500	213	0.6	180

20D-S 系列

规格	最大连续工作电压		压敏电压 V _{1mA} (V)	最大限制电压		最大峰值电流 (8/20μs)		最大能量 (10/1000μs) (J)	额定功率 (W)	静电容量 (参考值) 1KHz (pF)
	AC _{rms} (V)	DC _{rms} (V)		VC (V)	IP (A)	1 pulse (A)	2 pulse (A)			
STE-20D180KS	11	14	18(15-21.6)	36	20	2000	1000	11	0.2	28500
STE-20D220KS	14	18	22(19.5-26)	43	20	2000	1000	14	0.2	18500
STE-20D270KS	17	22	27(24-31)	53	20	2000	1000	16	0.2	13000
STE-20D330KS	20	26	33(29.5-36.5)	65	20	2000	1000	23	0.2	11500
STE-20D390KS	25	31	39(35-43)	77	20	2000	1000	26	0.2	8500
STE-20D470KS	30	38	47(42-52)	93	20	2000	1000	30	0.2	7400
STE-20D560KS	35	45	56(50-62)	110	20	2000	1000	38	0.2	6500
STE-20D680KS	40	56	68(61-75)	135	20	2000	1000	41	0.2	5800
STE-20D820KS	50	65	82(74-90)	135	100	6500	4500	45	1.0	7500
STE-20D101KS	60	85	100(90-110)	165	100	6500	4500	50	1.0	6500
STE-20D121KS	75	100	120(108-132)	200	100	6500	4500	55	1.0	5500
STE-20D151KS	95	125	150(135-165)	250	100	6500	4500	70	1.0	4500
STE-20D181KS	115	150	180(162-198)	300	100	6500	4500	85	1.0	2200
STE-20D201KS	130	170	200(180-220)	340	100	6500	4500	95	1.0	1700
STE-20D221KS	140	180	220(198-242)	360	100	6500	4500	100	1.0	1600
STE-20D241KS	150	200	240(216-264)	395	100	6500	4500	108	1.0	1500
STE-20D271KS	175	225	270(243-297)	455	100	6500	4500	127	1.0	1300
STE-20D301KS	190	250	300(270-330)	500	100	6500	4500	136	1.0	1300
STE-20D331KS	210	275	330(297-363)	550	100	6500	4500	150	1.0	1100
STE-20D361KS	230	300	360(324-396)	595	100	6500	4500	163	1.0	1100
STE-20D391KS	250	320	390(351-429)	650	100	6500	4500	180	1.0	1100
STE-20D431KS	275	350	430(387-473)	710	100	6500	4500	190	1.0	1000
STE-20D471KS	300	385	470(423-517)	775	100	6500	4500	204	1.0	900
STE-20D511KS	320	415	510(459-561)	845	100	6500	4500	210	1.0	800
STE-20D561KS	350	460	560(504-616)	925	100	6500	4500	215	1.0	710
STE-20D621KS	385	505	620(558-682)	1025	100	6500	4500	224	1.0	700
STE-20D681KS	420	560	680(612-748)	1120	100	6500	4500	230	1.0	650
STE-20D751KS	460	615	750(675-825)	1240	100	6500	4500	255	1.0	600
STE-20D781KS	485	640	780(702-858)	1290	100	6500	4500	265	1.0	510
STE-20D821KS	510	670	820(738-902)	1355	100	6500	4500	282	1.0	530
STE-20D911KS	550	745	910(819-1001)	1500	100	6500	4500	310	1.0	500
STE-20D102KS	625	825	1000(900-1100)	1650	100	6500	4500	342	1.0	450
STE-20D112KS	680	895	1100(990-1210)	1815	100	6500	4500	383	1.0	360

外形尺寸 (mm)和安规认证

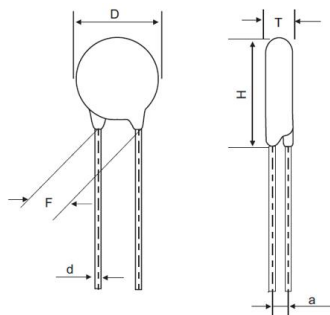

5D-S 系列

规格	尺寸 (mm)				安规认证			
	D Max.	T Max.	F±0.8	d±0.05	CQC	VDE	UL (美国)	cUL (加拿大)
STE-05D180KS	7.5	3.0	5.0	0.5			√	√
STE-05D220KS	7.5	3.5	5.0	0.5			√	√
STE-05D270KS	7.5	3.5	5.0	0.5			√	√
STE-05D330KS	7.5	3.5	5.0	0.5			√	√
STE-05D390KS	7.5	3.5	5.0	0.5			√	√
STE-05D470KS	7.5	4.0	5.0	0.5				
STE-05D560KS	7.5	4.0	5.0	0.5				
STE-05D680KS	7.5	4.5	5.0	0.5				
STE-05D820KS	7.5	3.5	5.0	0.5	√		√	√
STE-05D101KS	7.5	3.5	5.0	0.5	√		√	√
STE-05D121KS	7.5	3.5	5.0	0.5	√		√	√
STE-05D151KS	7.5	3.5	5.0	0.5	√		√	√
STE-05D181KS	7.5	4.0	5.0	0.5	√		√	√
STE-05D201KS	7.5	4.0	5.0	0.5	√		√	√
STE-05D221KS	7.5	4.0	5.0	0.5	√		√	
STE-05D241KS	7.5	4.0	5.0	0.5	√		√	
STE-05D271KS	7.5	4.0	5.0	0.5	√		√	
STE-05D301KS	7.5	4.5	5.0	0.5	√		√	
STE-05D331KS	7.5	4.5	5.0	0.5	√		√	
STE-05D361KS	7.5	4.5	5.0	0.5	√		√	
STE-05D391KS	7.5	5.0	5.0	0.5	√		√	
STE-05D431KS	7.5	4.5	5.0	0.5	√		√	
STE-05D471KS	7.5	4.5	5.0	0.5	√		√	
STE-05D511KS	7.5	5.0	5.0	0.5	√		√	
STE-05D561KS	7.5	5.0	5.0	0.5	√		√	
STE-05D621KS	7.5	5.0	5.0	0.5				
STE-05D681KS	7.5	5.5	5.0	0.5				

7D-S 系列

规格	尺寸 (mm)				安规认证			
	D Max.	T Max.	F±0.8	d±0.05	CQC	VDE	UL (美国)	cUL (加拿大)
STE-07D180KS	9.0	3.5	5.0	0.5			√	√
STE-07D220KS	9.0	3.5	5.0	0.5			√	√
STE-07D270KS	9.0	3.5	5.0	0.5			√	√
STE-07D330KS	9.0	3.5	5.0	0.5			√	√
STE-07D390KS	9.0	3.5	5.0	0.5			√	√
STE-07D470KS	9.0	4.0	5.0	0.5			√	√
STE-07D560KS	9.0	4.0	5.0	0.5			√	√
STE-07D680KS	9.0	4.5	5.0	0.5			√	√
STE-07D820KS	9.0	3.5	5.0	0.5	√	√	√	√
STE-07D101KS	9.0	3.5	5.0	0.5	√	√	√	√
STE-07D121KS	9.0	3.5	5.0	0.5	√	√	√	√
STE-07D151KS	9.0	3.5	5.0	0.5	√	√	√	√
STE-07D181KS	9.0	4.0	5.0	0.5	√	√	√	√
STE-07D201KS	9.0	4.0	5.0	0.5	√	√	√	√
STE-07D221KS	9.0	4.5	5.0	0.5	√	√	√	√
STE-07D241KS	9.0	4.0	5.0	0.5	√	√	√	√
STE-07D271KS	9.0	4.0	5.0	0.5	√	√	√	√
STE-07D301KS	9.0	4.5	5.0	0.5	√	√	√	√
STE-07D331KS	9.0	4.5	5.0	0.5	√	√	√	√
STE-07D361KS	9.0	4.5	5.0	0.5	√	√	√	√
STE-07D391KS	9.0	5.0	5.0	0.5	√	√	√	√
STE-07D431KS	9.0	4.5	5.0	0.5	√	√	√	√
STE-07D471KS	9.0	4.5	5.0	0.5	√	√	√	√
STE-07D511KS	9.0	5.0	5.0	0.5	√	√	√	√
STE-07D561KS	9.0	5.0	5.0	0.5	√	√	√	√
STE-07D621KS	9.0	5.0	5.0	0.5	√	√	√	√
STE-07D681KS	9.0	5.5	5.0	0.5	√	√	√	√

10D-S 系列

规格	尺寸 (mm)				安规认证			
	D Max.	T Max.	F±0.8	d±0.05	CQC	VDE	UL (美国)	cUL (加拿大)
STE-10D180KS	12.5	3.5	7.5	0.7			√	√
STE-10D220KS	12.5	3.5	7.5	0.7			√	√
STE-10D270KS	12.5	4.0	7.5	0.7			√	√
STE-10D330KS	12.5	4.0	7.5	0.7			√	√
STE-10D390KS	12.5	4.0	7.5	0.7			√	√
STE-10D470KS	12.5	4.0	7.5	0.7			√	√
STE-10D560KS	12.5	4.5	7.5	0.7			√	√
STE-10D680KS	12.5	5.0	7.5	0.7			√	√
STE-10D820KS	12.5	4.0	7.5	0.7	√	√	√	√
STE-10D101KS	12.5	4.0	7.5	0.7	√	√	√	√
STE-10D121KS	12.5	4.0	7.5	0.7	√	√	√	√
STE-10D151KS	12.5	4.5	7.5	0.7	√	√	√	√
STE-10D181KS	12.5	4.5	7.5	0.7	√	√	√	√
STE-10D201KS	12.5	4.5	7.5	0.7	√	√	√	√
STE-10D221KS	12.5	4.5	7.5	0.7	√	√	√	√
STE-10D241KS	12.5	4.5	7.5	0.7	√	√	√	√
STE-10D271KS	12.5	4.5	7.5	0.7	√	√	√	√
STE-10D301KS	12.5	5.0	7.5	0.7	√	√	√	√
STE-10D331KS	12.5	5.0	7.5	0.7	√	√	√	√
STE-10D361KS	12.5	5.0	7.5	0.7	√	√	√	√
STE-10D391KS	12.5	5.0	7.5	0.7	√	√	√	√
STE-10D431KS	12.5	5.0	7.5	0.7	√	√	√	√
STE-10D471KS	12.5	5.0	7.5	0.7	√	√	√	√
STE-10D511KS	12.5	5.5	7.5	0.7	√	√	√	√
STE-10D561KS	12.5	5.5	7.5	0.7	√	√	√	√
STE-10D621KS	12.5	5.5	7.5	0.7	√	√	√	√
STE-10D681KS	12.5	6.0	7.5	0.7	√	√	√	√
STE-10D751KS	12.5	6.0	7.5	0.7	√	√	√	√
STE-10D781KS	12.5	6.5	7.5	0.7			√	√
STE-10D821KS	12.5	6.5	7.5	0.7	√	√	√	√
STE-10D911KS	12.5	7.0	7.5	0.7	√	√	√	√
STE-10D102KS	12.5	7.5	7.5	0.7	√	√	√	√
STE-10D112KS	12.5	7.5	7.5	0.7	√		√	√

14D-S 系列

规格	尺寸 (mm)				安规认证			
	D Max.	T Max.	F±0.8	d±0.05	CQC	VDE	UL (美国)	cUL (加拿大)
STE-14D180KS	16.5	3.5	7.5	0.7			√	√
STE-14D220KS	16.5	3.5	7.5	0.7			√	√
STE-14D270KS	16.5	4.0	7.5	0.7			√	√
STE-14D330KS	16.5	4.0	7.5	0.7			√	√
STE-14D390KS	16.5	4.0	7.5	0.7			√	√
STE-14D470KS	16.5	4.0	7.5	0.7			√	√
STE-14D560KS	16.5	4.5	7.5	0.7			√	√
STE-14D680KS	16.5	5.0	7.5	0.7			√	√
STE-14D820KS	16.5	4.0	7.5	0.7	√	√	√	√
STE-14D101KS	16.5	4.0	7.5	0.7	√	√	√	√
STE-14D121KS	16.5	4.0	7.5	0.7	√	√	√	√
STE-14D151KS	16.5	4.5	7.5	0.7	√	√	√	√
STE-14D181KS	16.5	4.5	7.5	0.7	√	√	√	√
STE-14D201KS	16.5	4.5	7.5	0.7	√	√	√	√
STE-14D221KS	16.5	4.5	7.5	0.7	√	√	√	√
STE-14D241KS	16.5	4.5	7.5	0.7	√	√	√	√
STE-14D271KS	16.5	4.5	7.5	0.7	√	√	√	√
STE-14D301KS	16.5	5.0	7.5	0.7	√	√	√	√
STE-14D331KS	16.5	5.0	7.5	0.7	√	√	√	√
STE-14D361KS	16.5	5.0	7.5	0.7	√	√	√	√
STE-14D391KS	16.5	5.0	7.5	0.7	√	√	√	√
STE-14D431KS	16.5	5.0	7.5	0.7	√	√	√	√
STE-14D471KS	16.5	5.0	7.5	0.7	√	√	√	√
STE-14D511KS	16.5	5.5	7.5	0.7	√	√	√	√
STE-14D561KS	16.5	5.5	7.5	0.7	√	√	√	√
STE-14D621KS	16.5	5.5	7.5	0.7	√	√	√	√
STE-14D681KS	16.5	6.0	7.5	0.7	√	√	√	√
STE-14D751KS	16.5	6.0	7.5	0.7	√	√	√	√
STE-14D781KS	16.5	6.5	7.5	0.7			√	√
STE-14D821KS	16.5	6.5	7.5	0.7	√	√	√	√
STE-14D911KS	16.5	7.0	7.5	0.7	√	√	√	√
STE-14D102KS	16.5	7.5	7.5	0.7	√	√	√	√
STE-14D112KS	16.5	7.5	7.5	0.7	√		√	√

20D-S 系列

规格	尺寸 (mm)					安规认证			
	D Max.	T Max.	F±0.8	d±0.05		CQC	VDE	UL (美国)	cUL (加拿大)
				直脚脚型	弯脚脚型				
STE-20D180KS	23.0	4.0	10.0	1.0	0.7			√	√
STE-20D220KS	23.0	4.0	10.0	1.0	0.7			√	√
STE-20D270KS	23.0	4.5	10.0	1.0	0.7			√	√
STE-20D330KS	23.0	4.5	10.0	1.0	0.7			√	√
STE-20D390KS	23.0	4.5	10.0	1.0	0.7			√	√
STE-20D470KS	23.0	5.0	10.0	1.0	0.7			√	√
STE-20D560KS	23.0	5.0	10.0	1.0	0.7			√	√
STE-20D680KS	23.0	5.5	10.0	1.0	0.7			√	√
STE-20D820KS	23.0	4.0	10.0	1.0	0.7	√	√	√	√
STE-20D101KS	23.0	4.5	10.0	1.0	0.7	√	√	√	√
STE-20D121KS	23.0	4.5	10.0	1.0	0.7	√	√	√	√
STE-20D151KS	23.0	5.0	10.0	1.0	0.7	√	√	√	√
STE-20D181KS	23.0	5.0	10.0	1.0	0.7	√	√	√	√
STE-20D201KS	23.0	5.0	10.0	1.0	0.7	√	√	√	√
STE-20D221KS	23.0	5.5	10.0	1.0	0.7	√	√	√	√
STE-20D241KS	23.0	5.0	10.0	1.0	0.7	√	√	√	√
STE-20D271KS	23.0	5.0	10.0	1.0	0.7	√	√	√	√
STE-20D301KS	23.0	5.5	10.0	1.0	0.7	√	√	√	√
STE-20D331KS	23.0	5.5	10.0	1.0	0.7	√	√	√	√
STE-20D361KS	23.0	5.5	10.0	1.0	0.7	√	√	√	√
STE-20D391KS	23.0	5.5	10.0	1.0	0.7	√	√	√	√
STE-20D431KS	23.0	5.5	10.0	1.0	0.7	√	√	√	√
STE-20D471KS	23.0	5.5	10.0	1.0	0.7	√	√	√	√
STE-20D511KS	23.0	6.0	10.0	1.0	0.7	√	√	√	√
STE-20D561KS	23.0	6.0	10.0	1.0	0.7	√	√	√	√
STE-20D621KS	23.0	6.5	10.0	1.0	0.7	√	√	√	√
STE-20D681KS	23.0	6.5	10.0	1.0	0.7	√	√	√	√
STE-20D751KS	23.0	7.0	10.0	1.0	0.7	√	√	√	√
STE-20D781KS	23.0	7.0	10.0	1.0	0.7			√	√
STE-20D821KS	23.0	7.0	10.0	1.0	0.7	√	√	√	√
STE-20D911KS	23.0	7.5	10.0	1.0	0.7	√	√	√	√
STE-20D102KS	23.0	8.0	10.0	1.0	0.7	√	√	√	√
STE-20D112KS	23.0	8.0	10.0	1.0	0.7	√		√	√

脚型、脚长说明

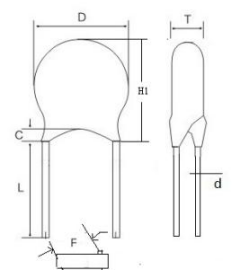
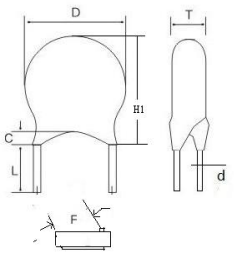
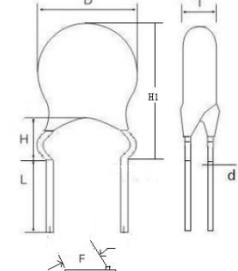
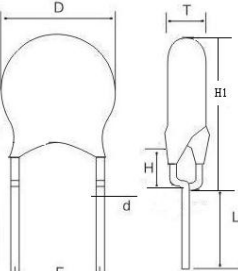
脚型	图示	脚长 L (mm)	包封脚长 C (mm)	高度 H (mm)
长直脚脚型		16.0 min	3.0 Max	/
短直脚脚型		①[2.5≤L<6.0]±0.5; ②[6.0≤L≤10]±1.0	3.0 Max	/
单外弯脚型		①[2.5≤L<6.0]±0.5; ②[6.0≤L≤10]±1.0	包封脚不超过弯点	5.5mm Max
前后翘脚型		①[2.5≤L<6.0]±0.5; ②[6.0≤L≤10]±1.0	包封脚不超过弯点	4.5mm Max

编带尺寸 (mm)

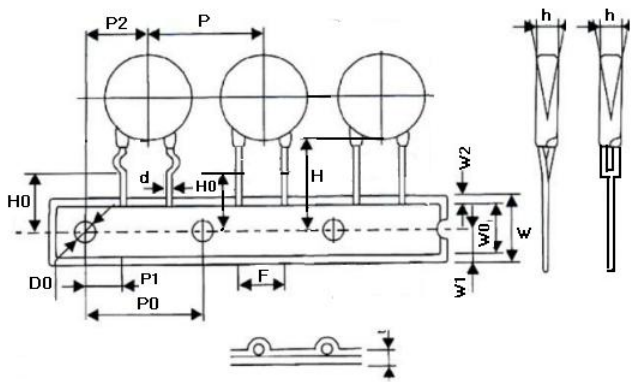
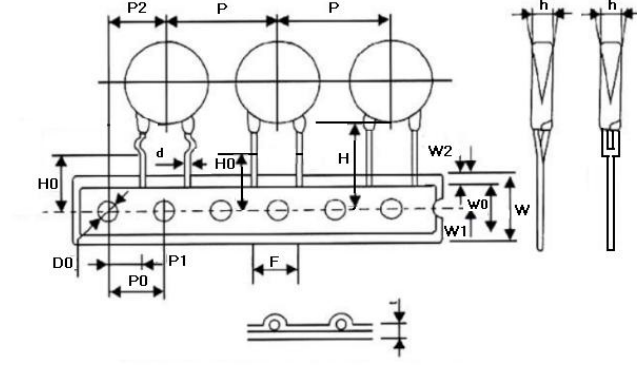
图示	Fig.1		Fig.2				
	代码	P=5.0	P=7.5		P=10.0		
	Po	12.7±0.3	12.7±0.3	12.7±0.3			
	P	12.7±1.0	25.4±1.0	25.4±1.0			
	P1	3.85±0.7	8.95±0.7	7.7±0.7			
	P2	6.35±1.3	12.7±1.3	12.7±1.3			
	F	5±0.8	7.5±0.8	10.0±0.8			
	Δh	0±2.0	0±2.0	0±2.0			
	W	18.0+1.5/-1.0	18.0 +1.5/-1.0	18.0 +1.5/-1.0			
	Wo	10.5 Max	10.5 Max	10.5 Max			
	W1	9.0+0.75/-0.5	9.0+0.75/-0.5	9.0+0.75/-0.5			
		W2	3.0 Max	3.0 Max	3.0 Max		
Do		4.0±0.2	4.0±0.2	4.0±0.2			
H		20+1.5/-1.0	20+1.5/-1.0	20+1.5/-1.0			
Ho		16.5&17.0&19.0 +1.5/-1.0	16.5&17.0&19.0 +1.5/-1.0	16.5&17.0&19.0 +1.5/-1.0			
L		直脚 脚型	弯脚 脚型	直脚 脚型	弯脚 脚型	直脚 脚型	弯脚 脚型
		11.0 Max	9.0 Max	11.0 Max	9.0 Max	11.0 Max	9.0 Max
t1		0.5±0.2	0.5±0.2	0.5±0.2			
Fig.2 (P=7.5 & 10)		t2	1.7 Max	1.7 Max	1.7 Max		

X-ON Electronics

Largest Supplier of Electrical and Electronic Components

Click to view similar products for [Varistors](#) category:

Click to view products by [Songtian](#) manufacturer:

Other Similar products are found below :

[820443211E](#) [MOV05131AIA](#) [MOV07231AQA](#) [MOV18131CZA](#) [R71ZOV151HC](#) [D58ZOV500RA01T1](#) [B72205S271K111](#)
[B72214S110K151](#) [B72214S251K151](#) [B72232B131K1](#) [B72530E1140S272](#) [B72540E250K62](#) [B72660M0271K093](#) [NTE1V020](#) [NTE1V130](#)
[NTE2V010](#) [NTE2V130](#) [25FN511K](#) [S10K11G5S5](#) [ERZ-C14DK361U](#) [ERZ-C20DK221U](#) [ERZ-C32CK201B](#) [207869-1](#) [AS-13](#)
[TMOV25SP625E](#) [B72210S251K531](#) [B72214S200K551](#) [B72280B112K1](#) [B72280B381K1](#) [B72590D360A60](#) [B72650M301K93](#)
[B72670M1140K72](#) [MOV07251ARA](#) [MOV10131EDA](#) [MOV10151EFA](#) [MOV14151CWA](#) [MOV20251DFA](#) [TVZ18EC271KBS](#)
[TVZ20EB911KBS](#) [TVZ25D201KBS](#) [TVZ25D241KBS](#) [VDRH20X230BSE](#) [VZ07D220KBS](#) [VZ40D241K](#) [VZ25D511KBS-N](#)
[VZ20E511KBSX](#) [VZ20E221KBSX](#) [VZ10D471KBS-N](#) [ERZ-V20R201](#) [ERZ-V20R221](#)