

Metal Oxide Varistors-S Series (Standard) Data Sheet



Feature

- Wide operating voltage range from 18V to 1100V
- Operating Temperature: -40°C ~ +105°C
- Storage Temperature: 15°C ~ 35°C

Applications

- The over-voltage protection for transistors, IC, SCR and semiconductor switching components and a variety of electronic, electrical equipment
- Surge absorption and over-voltage protection for household appliances
- Industrial electrical surge absorption
- Electrostatic discharge and noise signal cancellation
- Surge absorption of relays and solenoid valves
- Over-voltage protection for leakage switch
- The lightning protection and over-voltage protection for Telephone program-controlled switches and communications equipment

Applicable Standard

| Approval | | Organization | Safety Standards | Certificate No. |
|---------------|---|--------------|------------------------|---------------------|
| China |  | CQC | GB/T10193 GB/T10194 | 5D: CQC07001020534 |
| | | | | 7D: CQC07001020533 |
| | | | | 10D: CQC07001020532 |
| | | | | 14D: CQC07001020531 |
| | | | | 20D: CQC07001020530 |
| USA Canada |  | UL | UL1449 | E330837 |
| Germany |  | VDE | IEC61051 | 40023049 |

Part Number Code

Inner Management

| | | | | | | | | | | | | | |
|-----|----|---|-----|---|---|---|----|---|---|---|---|---|---|
| STE | 10 | D | 471 | K | 1 | E | N0 | F | S | B | 0 | R | 0 |
|-----|----|---|-----|---|---|---|----|---|---|---|---|---|---|

Songtian
(STE)

Product Categories
D: (Circular)

Tolerance
K:±10%

Pitch
B:5.0mm
E:7.5mm
D:10.0mm

Package
B: Bulk
T:Tape

Environmental Standard
R: RoHS
F: RoHS+Halogen-Free

Core Diameter
05:5mm
07:7mm
10:10mm
14:14mm
20:20mm

Foot Type
1:Long straight
2:Outside Crimped
3:Short Straight
8:Vertical Crimped

Style
S: Standard

Lead Material
F: Tinned copper clad steel wire
C:Copper wire

Nominal Varistor Voltage
220:22V
471:470V
122:1200V

Lead Length
S0~S9:1.0~1.9mm
X0~X9:2.0~2.9mm
A0~A9:3.0~3.9mm
B0~B9:4.0~4.9mm
C0~C9:5.0~5.9mm
D0~D9:6.0~6.9mm
E0~E9:7.0~7.9mm

Lead Length
F0~F9:8.0~8.9mm
G0~G9:9.0~9.9mm
H0~H9:10.0~10.9mm
J0~J9:11.0~11.9mm
K0~K9:12.0~12.9mm
L0~L9:13.0~13.9mm
M0~M9:14.0~14.9mm

Lead Length
M0~M9:14.0~14.9mm
N0:16~27.0mm(Bulk)
Crimped Lead Taped
N0:H0=16.5mm
P0:H0=17.0mm
Q0:H0=19.0mm
Straight Lead
Q0:20.0mm

Electrical Characteristics

5D-S Series

| Part Number | Maximum Allowable Voltage | | Varistor Voltage $V_{0.1mA}$ (V) | Maximum Clamping Voltage | | Peak Current Rating(8/20 μ s) | | Maximum Energy (10/1000 μ s) (J) | Rated Power (W) | Typical Capacitance (Reference) 1KHz (pF) |
|--------------|---------------------------|--------------------------|--|--------------------------|-----------|-----------------------------------|----------------|--|--------------------|--|
| | AC _{rms} (V) | DC _{rms} (V) | | VC (V) | IP (A) | 1 pulse (A) | 2 pulse (A) | | | |
| STE-05D180KS | 11 | 14 | 18(15-21.6) | 40 | 1 | 100 | 50 | 0.4 | 0.01 | 1400 |
| STE-05D220KS | 14 | 18 | 22(19.5-26) | 48 | 1 | 100 | 50 | 0.5 | 0.01 | 1150 |
| STE-05D270KS | 17 | 22 | 27(24-31) | 60 | 1 | 100 | 50 | 0.6 | 0.01 | 930 |
| STE-05D330KS | 20 | 26 | 33(29.5-36.5) | 73 | 1 | 100 | 50 | 0.8 | 0.01 | 760 |
| STE-05D390KS | 25 | 31 | 39(35-43) | 80 | 1 | 100 | 50 | 0.9 | 0.01 | 640 |
| STE-05D470KS | 30 | 38 | 47(42-52) | 104 | 1 | 100 | 50 | 1.1 | 0.01 | 530 |
| STE-05D560KS | 35 | 45 | 56(50-62) | 123 | 1 | 100 | 50 | 1.3 | 0.01 | 450 |
| STE-05D680KS | 40 | 56 | 68(61-75) | 145 | 1 | 100 | 50 | 1.6 | 0.01 | 370 |
| STE-05D820KS | 50 | 65 | 82(74-90) | 150 | 5 | 400 | 200 | 2.5 | 0.1 | 300 |
| STE-05D101KS | 60 | 85 | 100(90-110) | 175 | 5 | 400 | 200 | 3.0 | 0.1 | 250 |
| STE-05D121KS | 75 | 100 | 120(108-132) | 210 | 5 | 400 | 200 | 3.5 | 0.1 | 210 |
| STE-05D151KS | 95 | 125 | 150(135-165) | 260 | 5 | 400 | 200 | 4.5 | 0.1 | 165 |
| STE-05D181KS | 115 | 150 | 180(162-198) | 320 | 5 | 400 | 200 | 5.9 | 0.1 | 140 |
| STE-05D201KS | 130 | 170 | 200(180-220) | 355 | 5 | 400 | 200 | 6.5 | 0.1 | 125 |
| STE-05D221KS | 140 | 180 | 220(198-242) | 380 | 5 | 400 | 200 | 7.0 | 0.1 | 110 |
| STE-05D241KS | 150 | 200 | 240(216-264) | 415 | 5 | 400 | 200 | 8.0 | 0.1 | 100 |
| STE-05D271KS | 175 | 225 | 270(243-297) | 475 | 5 | 400 | 200 | 8.5 | 0.1 | 95 |
| STE-05D301KS | 190 | 250 | 300(270-330) | 520 | 5 | 400 | 200 | 9.0 | 0.1 | 85 |
| STE-05D331KS | 210 | 275 | 330(297-363) | 570 | 5 | 400 | 200 | 9.5 | 0.1 | 75 |
| STE-05D361KS | 230 | 300 | 360(324-396) | 620 | 5 | 400 | 200 | 10.0 | 0.1 | 70 |
| STE-05D391KS | 250 | 320 | 390(351-429) | 675 | 5 | 400 | 200 | 12.0 | 0.1 | 65 |
| STE-05D431KS | 275 | 350 | 430(387-473) | 745 | 5 | 400 | 200 | 13.0 | 0.1 | 60 |
| STE-05D471KS | 300 | 385 | 470(423-517) | 810 | 5 | 400 | 200 | 15.0 | 0.1 | 55 |
| STE-05D511KS | 320 | 415 | 510(459-561) | 845 | 5 | 400 | 200 | 16.0 | 0.1 | 50 |
| STE-05D561KS | 350 | 460 | 560(504-616) | 920 | 5 | 400 | 200 | 16.8 | 0.1 | 45 |
| STE-05D621KS | 385 | 505 | 620(558-682) | 1025 | 5 | 400 | 200 | 17.7 | 0.1 | 40 |
| STE-05D681KS | 420 | 560 | 680(612-748) | 1120 | 5 | 400 | 200 | 19.4 | 0.1 | 38 |

7D-S Series

| Part Number | Maximum Allowable Voltage | | Varistor Voltage V_{1mA} (V) | Maximum Clamping Voltage | | Peak Current Rating(8/20 μ s) | | Maximum Energy (10/1000 μ s) (J) | Rated Power (W) | Typical Capacitance (Reference) 1KHz (pF) |
|--------------|---------------------------|--------------------------|--------------------------------------|--------------------------|-----------|-----------------------------------|----------------|--|--------------------|--|
| | AC _{rms} (V) | DC _{rms} (V) | | VC (V) | IP (A) | 1 pulse (A) | 2 pulse (A) | | | |
| STE-07D180KS | 11 | 14 | 18(15-21.6) | 36 | 2.5 | 250 | 125 | 0.9 | 0.02 | 2800 |
| STE-07D220KS | 14 | 18 | 22(19.5-26) | 43 | 2.5 | 250 | 125 | 1.1 | 0.02 | 2300 |
| STE-07D270KS | 17 | 22 | 27(24-31) | 53 | 2.5 | 250 | 125 | 1.4 | 0.02 | 1800 |
| STE-07D330KS | 20 | 26 | 33(29.5-36.5) | 65 | 2.5 | 250 | 125 | 1.7 | 0.02 | 1500 |
| STE-07D390KS | 25 | 31 | 39(35-43) | 77 | 2.5 | 250 | 125 | 2.1 | 0.02 | 1300 |
| STE-07D470KS | 30 | 38 | 47(42-52) | 93 | 2.5 | 250 | 125 | 2.5 | 0.02 | 1100 |
| STE-07D560KS | 35 | 45 | 56(50-62) | 110 | 2.5 | 250 | 125 | 3.1 | 0.02 | 890 |
| STE-07D680KS | 40 | 56 | 68(61-75) | 135 | 2.5 | 250 | 125 | 3.6 | 0.02 | 740 |
| STE-07D820KS | 50 | 65 | 82(74-90) | 135 | 10 | 1200 | 600 | 5.5 | 0.25 | 810 |
| STE-07D101KS | 60 | 85 | 100(90-110) | 165 | 10 | 1200 | 600 | 6.5 | 0.25 | 700 |
| STE-07D121KS | 75 | 100 | 120(108-132) | 200 | 10 | 1200 | 600 | 7.8 | 0.25 | 590 |
| STE-07D151KS | 95 | 125 | 150(135-165) | 250 | 10 | 1200 | 600 | 9.7 | 0.25 | 500 |
| STE-07D181KS | 115 | 150 | 180(162-198) | 300 | 10 | 1200 | 600 | 11.7 | 0.25 | 280 |
| STE-07D201KS | 130 | 170 | 200(180-220) | 340 | 10 | 1200 | 600 | 13.0 | 0.25 | 200 |
| STE-07D221KS | 140 | 180 | 220(198-242) | 360 | 10 | 1200 | 600 | 14.0 | 0.25 | 190 |
| STE-07D241KS | 150 | 200 | 240(216-264) | 395 | 10 | 1200 | 600 | 15.0 | 0.25 | 170 |
| STE-07D271KS | 175 | 225 | 270(243-297) | 455 | 10 | 1200 | 600 | 18.0 | 0.25 | 150 |
| STE-07D301KS | 190 | 250 | 300(270-330) | 500 | 10 | 1200 | 600 | 20.0 | 0.25 | 140 |
| STE-07D331KS | 210 | 275 | 330(297-363) | 550 | 10 | 1200 | 600 | 23.0 | 0.25 | 130 |
| STE-07D361KS | 230 | 300 | 360(324-396) | 595 | 10 | 1200 | 600 | 24.0 | 0.25 | 130 |
| STE-07D391KS | 250 | 320 | 390(351-429) | 650 | 10 | 1200 | 600 | 26.0 | 0.25 | 130 |
| STE-07D431KS | 275 | 350 | 430(387-473) | 710 | 10 | 1200 | 600 | 28.0 | 0.25 | 120 |
| STE-07D471KS | 300 | 385 | 470(423-517) | 775 | 10 | 1200 | 600 | 29.0 | 0.25 | 100 |
| STE-07D511KS | 320 | 415 | 510(459-561) | 845 | 10 | 1200 | 600 | 31.0 | 0.25 | 90 |
| STE-07D561KS | 350 | 460 | 560(504-616) | 925 | 10 | 1200 | 600 | 35.0 | 0.25 | 90 |
| STE-07D621KS | 385 | 505 | 620(558-682) | 1025 | 10 | 1200 | 600 | 38.0 | 0.25 | 80 |
| STE-07D681KS | 420 | 560 | 680(612-748) | 1120 | 10 | 1200 | 600 | 42.0 | 0.25 | 75 |

10D-S Series

| Part Number | Maximum Allowable Voltage | | Varistor Voltage V _{1mA} (V) | Maximum Clamping Voltage | | Peak Current Rating(8/20μs) | | Maximum Energy (10/1000μs) (J) | Rated Power (W) | Typical Capacitance (Reference) 1KHz (pF) |
|--------------|---------------------------|--------------------------|---|--------------------------|-----------|-----------------------------|----------------|--------------------------------------|--------------------|--|
| | AC _{rms} (V) | DC _{rms} (V) | | VC (V) | IP (A) | 1 pulse (A) | 2 pulse (A) | | | |
| STE-10D180KS | 11 | 14 | 18(15-21.6) | 36 | 5 | 500 | 250 | 2.1 | 0.05 | 5600 |
| STE-10D220KS | 14 | 18 | 22(19.5-26) | 43 | 5 | 500 | 250 | 2.5 | 0.05 | 4500 |
| STE-10D270KS | 17 | 22 | 27(24-31) | 53 | 5 | 500 | 250 | 3.0 | 0.05 | 3700 |
| STE-10D330KS | 20 | 26 | 33(29.5-36.5) | 65 | 5 | 500 | 250 | 4.0 | 0.05 | 3000 |
| STE-10D390KS | 25 | 31 | 39(35-43) | 77 | 5 | 500 | 250 | 4.6 | 0.05 | 2400 |
| STE-10D470KS | 30 | 38 | 47(42-52) | 93 | 5 | 500 | 250 | 5.5 | 0.05 | 2100 |
| STE-10D560KS | 35 | 45 | 56(50-62) | 110 | 5 | 500 | 250 | 7.0 | 0.05 | 1800 |
| STE-10D680KS | 40 | 56 | 68(61-75) | 135 | 5 | 500 | 250 | 8.2 | 0.05 | 1500 |
| STE-10D820KS | 50 | 65 | 82(74-90) | 135 | 25 | 2500 | 1250 | 12.0 | 0.4 | 2000 |
| STE-10D101KS | 60 | 85 | 100(90-110) | 165 | 25 | 2500 | 1250 | 15.0 | 0.4 | 1700 |
| STE-10D121KS | 75 | 100 | 120(108-132) | 200 | 25 | 2500 | 1250 | 18.0 | 0.4 | 1400 |
| STE-10D151KS | 95 | 125 | 150(135-165) | 250 | 25 | 2500 | 1250 | 22.0 | 0.4 | 1100 |
| STE-10D181KS | 115 | 150 | 180(162-198) | 300 | 25 | 2500 | 1250 | 27.0 | 0.4 | 560 |
| STE-10D201KS | 130 | 170 | 200(180-220) | 340 | 25 | 2500 | 1250 | 30.0 | 0.4 | 430 |
| STE-10D221KS | 140 | 180 | 220(198-242) | 360 | 25 | 2500 | 1250 | 32.0 | 0.4 | 410 |
| STE-10D241KS | 150 | 200 | 240(216-264) | 395 | 25 | 2500 | 1250 | 35.0 | 0.4 | 380 |
| STE-10D271KS | 175 | 225 | 270(243-297) | 455 | 25 | 2500 | 1250 | 37.0 | 0.4 | 350 |
| STE-10D301KS | 190 | 250 | 300(270-330) | 500 | 25 | 2500 | 1250 | 40.0 | 0.4 | 330 |
| STE-10D331KS | 210 | 275 | 330(297-363) | 550 | 25 | 2500 | 1250 | 43.0 | 0.4 | 300 |
| STE-10D361KS | 230 | 300 | 360(324-396) | 595 | 25 | 2500 | 1250 | 47.0 | 0.4 | 300 |
| STE-10D391KS | 250 | 320 | 390(351-429) | 650 | 25 | 2500 | 1250 | 60.0 | 0.4 | 300 |
| STE-10D431KS | 275 | 350 | 430(387-473) | 710 | 25 | 2500 | 1250 | 65.0 | 0.4 | 270 |
| STE-10D471KS | 300 | 385 | 470(423-517) | 775 | 25 | 2500 | 1250 | 67.0 | 0.4 | 230 |
| STE-10D511KS | 320 | 415 | 510(459-561) | 845 | 25 | 2500 | 1250 | 69.0 | 0.4 | 210 |
| STE-10D561KS | 350 | 460 | 560(504-616) | 925 | 25 | 2500 | 1250 | 70.0 | 0.4 | 180 |
| STE-10D621KS | 385 | 505 | 620(558-682) | 1025 | 25 | 2500 | 1250 | 72.0 | 0.4 | 190 |
| STE-10D681KS | 420 | 560 | 680(612-748) | 1120 | 25 | 2500 | 1250 | 75.0 | 0.4 | 170 |
| STE-10D751KS | 460 | 615 | 750(675-825) | 1240 | 25 | 2500 | 1250 | 77.0 | 0.4 | 160 |
| STE-10D781KS | 485 | 640 | 780(702-858) | 1290 | 25 | 2500 | 1250 | 80.0 | 0.4 | 125 |
| STE-10D821KS | 510 | 670 | 820(738-902) | 1355 | 25 | 2500 | 1250 | 85.0 | 0.4 | 140 |
| STE-10D911KS | 550 | 745 | 910(819-1001) | 1500 | 25 | 2500 | 1250 | 93.0 | 0.4 | 120 |
| STE-10D102KS | 625 | 825 | 1000(900-1100) | 1650 | 25 | 2500 | 1250 | 102.0 | 0.4 | 110 |
| STE-10D112KS | 680 | 895 | 1100(990-1210) | 1815 | 25 | 2500 | 1250 | 115.0 | 0.4 | 90 |

14D-S Series

| Part Number | Maximum Allowable Voltage | | Varistor Voltage V _{1mA} (V) | Maximum Clamping Voltage | | Peak Current Rating(8/20μs) | | Maximum Energy (10/1000μs) (J) | Rated Power (W) | Typical Capacitance (Reference) 1KHz (pF) |
|--------------|---------------------------|--------------------------|---|--------------------------|-----------|-----------------------------|----------------|--------------------------------------|--------------------|--|
| | AC _{rms} (V) | DC _{rms} (V) | | VC (V) | IP (A) | 1 pulse (A) | 2 pulse (A) | | | |
| STE-14D180KS | 11 | 14 | 18(15-21.6) | 36 | 10 | 1000 | 500 | 4.0 | 0.1 | 11100 |
| STE-14D220KS | 14 | 18 | 22(19.5-26) | 43 | 10 | 1000 | 500 | 5.0 | 0.1 | 9100 |
| STE-14D270KS | 17 | 22 | 27(24-31) | 53 | 10 | 1000 | 500 | 6.0 | 0.1 | 7400 |
| STE-14D330KS | 20 | 26 | 33(29.5-36.5) | 65 | 10 | 1000 | 500 | 7.5 | 0.1 | 6100 |
| STE-14D390KS | 25 | 31 | 39(35-43) | 77 | 10 | 1000 | 500 | 8.6 | 0.1 | 5100 |
| STE-14D470KS | 30 | 38 | 47(42-52) | 93 | 10 | 1000 | 500 | 10.0 | 0.1 | 4300 |
| STE-14D560KS | 35 | 45 | 56(50-62) | 110 | 10 | 1000 | 500 | 11.0 | 0.1 | 3600 |
| STE-14D680KS | 40 | 56 | 68(61-75) | 135 | 10 | 1000 | 500 | 14.0 | 0.1 | 2900 |
| STE-14D820KS | 50 | 65 | 82(74-90) | 135 | 50 | 4500 | 2500 | 22.0 | 0.6 | 3700 |
| STE-14D101KS | 60 | 85 | 100(90-110) | 165 | 50 | 4500 | 2500 | 28.0 | 0.6 | 3200 |
| STE-14D121KS | 75 | 100 | 120(108-132) | 200 | 50 | 4500 | 2500 | 32.0 | 0.6 | 2700 |
| STE-14D151KS | 95 | 125 | 150(135-165) | 250 | 50 | 4500 | 2500 | 40.0 | 0.6 | 2200 |
| STE-14D181KS | 115 | 150 | 180(162-198) | 300 | 50 | 4500 | 2500 | 50.0 | 0.6 | 1100 |
| STE-14D201KS | 130 | 170 | 200(180-220) | 340 | 50 | 4500 | 2500 | 57.0 | 0.6 | 770 |
| STE-14D221KS | 140 | 180 | 220(198-242) | 360 | 50 | 4500 | 2500 | 60.0 | 0.6 | 740 |
| STE-14D241KS | 150 | 200 | 240(216-264) | 395 | 50 | 4500 | 2500 | 63.0 | 0.6 | 700 |
| STE-14D271KS | 175 | 225 | 270(243-297) | 455 | 50 | 4500 | 2500 | 70.0 | 0.6 | 640 |
| STE-14D301KS | 190 | 250 | 300(270-330) | 500 | 50 | 4500 | 2500 | 77.0 | 0.6 | 670 |
| STE-14D331KS | 210 | 275 | 330(297-363) | 550 | 50 | 4500 | 2500 | 85.0 | 0.6 | 580 |
| STE-14D361KS | 230 | 300 | 360(324-396) | 595 | 50 | 4500 | 2500 | 93.0 | 0.6 | 540 |
| STE-14D391KS | 250 | 320 | 390(351-429) | 650 | 50 | 4500 | 2500 | 100 | 0.6 | 500 |
| STE-14D431KS | 275 | 350 | 430(387-473) | 710 | 50 | 4500 | 2500 | 115 | 0.6 | 450 |
| STE-14D471KS | 300 | 385 | 470(423-517) | 775 | 50 | 4500 | 2500 | 118 | 0.6 | 400 |
| STE-14D511KS | 320 | 415 | 510(459-561) | 845 | 50 | 4500 | 2500 | 121 | 0.6 | 350 |
| STE-14D561KS | 350 | 460 | 560(504-616) | 925 | 50 | 4500 | 2500 | 125 | 0.6 | 360 |
| STE-14D621KS | 385 | 505 | 620(558-682) | 1025 | 50 | 4500 | 2500 | 128 | 0.6 | 330 |
| STE-14D681KS | 420 | 560 | 680(612-748) | 1120 | 50 | 4500 | 2500 | 130 | 0.6 | 320 |
| STE-14D751KS | 460 | 615 | 750(675-825) | 1240 | 50 | 4500 | 2500 | 143 | 0.6 | 310 |
| STE-14D781KS | 485 | 640 | 780(702-858) | 1290 | 50 | 4500 | 2500 | 148 | 0.6 | 260 |
| STE-14D821KS | 510 | 670 | 820(738-902) | 1355 | 50 | 4500 | 2500 | 157 | 0.6 | 280 |
| STE-14D911KS | 550 | 745 | 910(819-1001) | 1500 | 50 | 4500 | 2500 | 175 | 0.6 | 250 |
| STE-14D102KS | 625 | 825 | 1000(900-1100) | 1650 | 50 | 4500 | 2500 | 190 | 0.6 | 230 |
| STE-14D112KS | 680 | 895 | 1100(990-1210) | 1815 | 50 | 4500 | 2500 | 213 | 0.6 | 180 |

20D-S Series

| Part Number | Maximum Allowable Voltage | | Varistor Voltage V _{1mA} (V) | Maximum Clamping Voltage | | Peak Current Rating(8/20μs) | | Maximum Energy (10/1000μs) (J) | Rated Power (W) | Typical Capacitance (Reference) 1KHz (pF) |
|--------------|---------------------------|--------------------------|---|--------------------------|-----------|-----------------------------|----------------|--------------------------------------|--------------------|--|
| | AC _{rms} (V) | DC _{rms} (V) | | VC (V) | IP (A) | 1 pulse (A) | 2 pulse (A) | | | |
| STE-20D180KS | 11 | 14 | 18(15-21.6) | 36 | 20 | 2000 | 1000 | 11 | 0.2 | 28500 |
| STE-20D220KS | 14 | 18 | 22(19.5-26) | 43 | 20 | 2000 | 1000 | 14 | 0.2 | 18500 |
| STE-20D270KS | 17 | 22 | 27(24-31) | 53 | 20 | 2000 | 1000 | 16 | 0.2 | 13000 |
| STE-20D330KS | 20 | 26 | 33(29.5-36.5) | 65 | 20 | 2000 | 1000 | 23 | 0.2 | 11500 |
| STE-20D390KS | 25 | 31 | 39(35-43) | 77 | 20 | 2000 | 1000 | 26 | 0.2 | 8500 |
| STE-20D470KS | 30 | 38 | 47(42-52) | 93 | 20 | 2000 | 1000 | 30 | 0.2 | 7400 |
| STE-20D560KS | 35 | 45 | 56(50-62) | 110 | 20 | 2000 | 1000 | 38 | 0.2 | 6500 |
| STE-20D680KS | 40 | 56 | 68(61-75) | 135 | 20 | 2000 | 1000 | 41 | 0.2 | 5800 |
| STE-20D820KS | 50 | 65 | 82(74-90) | 135 | 100 | 6500 | 4500 | 45 | 1.0 | 7500 |
| STE-20D101KS | 60 | 85 | 100(90-110) | 165 | 100 | 6500 | 4500 | 50 | 1.0 | 6500 |
| STE-20D121KS | 75 | 100 | 120(108-132) | 200 | 100 | 6500 | 4500 | 55 | 1.0 | 5500 |
| STE-20D151KS | 95 | 125 | 150(135-165) | 250 | 100 | 6500 | 4500 | 70 | 1.0 | 4500 |
| STE-20D181KS | 115 | 150 | 180(162-198) | 300 | 100 | 6500 | 4500 | 85 | 1.0 | 2200 |
| STE-20D201KS | 130 | 170 | 200(180-220) | 340 | 100 | 6500 | 4500 | 95 | 1.0 | 1700 |
| STE-20D221KS | 140 | 180 | 220(198-242) | 360 | 100 | 6500 | 4500 | 100 | 1.0 | 1600 |
| STE-20D241KS | 150 | 200 | 240(216-264) | 395 | 100 | 6500 | 4500 | 108 | 1.0 | 1500 |
| STE-20D271KS | 175 | 225 | 270(243-297) | 455 | 100 | 6500 | 4500 | 127 | 1.0 | 1300 |
| STE-20D301KS | 190 | 250 | 300(270-330) | 500 | 100 | 6500 | 4500 | 136 | 1.0 | 1300 |
| STE-20D331KS | 210 | 275 | 330(297-363) | 550 | 100 | 6500 | 4500 | 150 | 1.0 | 1100 |
| STE-20D361KS | 230 | 300 | 360(324-396) | 595 | 100 | 6500 | 4500 | 163 | 1.0 | 1100 |
| STE-20D391KS | 250 | 320 | 390(351-429) | 650 | 100 | 6500 | 4500 | 180 | 1.0 | 1100 |
| STE-20D431KS | 275 | 350 | 430(387-473) | 710 | 100 | 6500 | 4500 | 190 | 1.0 | 1000 |
| STE-20D471KS | 300 | 385 | 470(423-517) | 775 | 100 | 6500 | 4500 | 204 | 1.0 | 900 |
| STE-20D511KS | 320 | 415 | 510(459-561) | 845 | 100 | 6500 | 4500 | 210 | 1.0 | 800 |
| STE-20D561KS | 350 | 460 | 560(504-616) | 925 | 100 | 6500 | 4500 | 215 | 1.0 | 710 |
| STE-20D621KS | 385 | 505 | 620(558-682) | 1025 | 100 | 6500 | 4500 | 224 | 1.0 | 700 |
| STE-20D681KS | 420 | 560 | 680(612-748) | 1120 | 100 | 6500 | 4500 | 230 | 1.0 | 650 |
| STE-20D751KS | 460 | 615 | 750(675-825) | 1240 | 100 | 6500 | 4500 | 255 | 1.0 | 600 |
| STE-20D781KS | 485 | 640 | 780(702-858) | 1290 | 100 | 6500 | 4500 | 265 | 1.0 | 510 |
| STE-20D821KS | 510 | 670 | 820(738-902) | 1355 | 100 | 6500 | 4500 | 282 | 1.0 | 530 |
| STE-20D911KS | 550 | 745 | 910(819-1001) | 1500 | 100 | 6500 | 4500 | 310 | 1.0 | 500 |
| STE-20D102KS | 625 | 825 | 1000(900-1100) | 1650 | 100 | 6500 | 4500 | 342 | 1.0 | 450 |
| STE-20D112KS | 680 | 895 | 1100(990-1210) | 1815 | 100 | 6500 | 4500 | 383 | 1.0 | 360 |

Dimensions (mm) and Approval

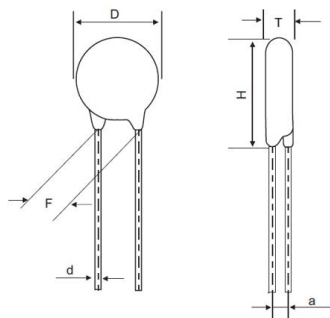

5D-S Series

| Part No. | Size (mm) | | | | Approval | | | |
|--------------|-----------|--------|-------|--------|----------|-----|----------|--------------|
| | D Max. | T Max. | F±0.8 | d±0.05 | CQC | VDE | UL (USA) | cUL (Canada) |
| STE-05D180KS | 7.5 | 3.0 | 5.0 | 0.5 | | | √ | √ |
| STE-05D220KS | 7.5 | 3.5 | 5.0 | 0.5 | | | √ | √ |
| STE-05D270KS | 7.5 | 3.5 | 5.0 | 0.5 | | | √ | √ |
| STE-05D330KS | 7.5 | 3.5 | 5.0 | 0.5 | | | √ | √ |
| STE-05D390KS | 7.5 | 3.5 | 5.0 | 0.5 | | | √ | √ |
| STE-05D470KS | 7.5 | 4.0 | 5.0 | 0.5 | | | | |
| STE-05D560KS | 7.5 | 4.0 | 5.0 | 0.5 | | | | |
| STE-05D680KS | 7.5 | 4.5 | 5.0 | 0.5 | | | | |
| STE-05D820KS | 7.5 | 3.5 | 5.0 | 0.5 | √ | | √ | √ |
| STE-05D101KS | 7.5 | 3.5 | 5.0 | 0.5 | √ | | √ | √ |
| STE-05D121KS | 7.5 | 3.5 | 5.0 | 0.5 | √ | | √ | √ |
| STE-05D151KS | 7.5 | 3.5 | 5.0 | 0.5 | √ | | √ | √ |
| STE-05D181KS | 7.5 | 4.0 | 5.0 | 0.5 | √ | | √ | √ |
| STE-05D201KS | 7.5 | 4.0 | 5.0 | 0.5 | √ | | √ | √ |
| STE-05D221KS | 7.5 | 4.0 | 5.0 | 0.5 | √ | | √ | |
| STE-05D241KS | 7.5 | 4.0 | 5.0 | 0.5 | √ | | √ | |
| STE-05D271KS | 7.5 | 4.0 | 5.0 | 0.5 | √ | | √ | |
| STE-05D301KS | 7.5 | 4.5 | 5.0 | 0.5 | √ | | √ | |
| STE-05D331KS | 7.5 | 4.5 | 5.0 | 0.5 | √ | | √ | |
| STE-05D361KS | 7.5 | 4.5 | 5.0 | 0.5 | √ | | √ | |
| STE-05D391KS | 7.5 | 5.0 | 5.0 | 0.5 | √ | | √ | |
| STE-05D431KS | 7.5 | 4.5 | 5.0 | 0.5 | √ | | √ | |
| STE-05D471KS | 7.5 | 4.5 | 5.0 | 0.5 | √ | | √ | |
| STE-05D511KS | 7.5 | 5.0 | 5.0 | 0.5 | √ | | √ | |
| STE-05D561KS | 7.5 | 5.0 | 5.0 | 0.5 | √ | | √ | |
| STE-05D621KS | 7.5 | 5.0 | 5.0 | 0.5 | | | | |
| STE-05D681KS | 7.5 | 5.5 | 5.0 | 0.5 | | | | |

7D-S Series

| Part No. | Size (mm) | | | | Approval | | | |
|--------------|-----------|--------|-------|--------|----------|-----|----------|--------------|
| | D Max. | T Max. | F±0.8 | d±0.05 | CQC | VDE | UL (USA) | cUL (Canada) |
| STE-07D180KS | 9.0 | 3.5 | 5.0 | 0.5 | | | √ | √ |
| STE-07D220KS | 9.0 | 3.5 | 5.0 | 0.5 | | | √ | √ |
| STE-07D270KS | 9.0 | 3.5 | 5.0 | 0.5 | | | √ | √ |
| STE-07D330KS | 9.0 | 3.5 | 5.0 | 0.5 | | | √ | √ |
| STE-07D390KS | 9.0 | 3.5 | 5.0 | 0.5 | | | √ | √ |
| STE-07D470KS | 9.0 | 4.0 | 5.0 | 0.5 | | | √ | √ |
| STE-07D560KS | 9.0 | 4.0 | 5.0 | 0.5 | | | √ | √ |
| STE-07D680KS | 9.0 | 4.5 | 5.0 | 0.5 | | | √ | √ |
| STE-07D820KS | 9.0 | 3.5 | 5.0 | 0.5 | √ | √ | √ | √ |
| STE-07D101KS | 9.0 | 3.5 | 5.0 | 0.5 | √ | √ | √ | √ |
| STE-07D121KS | 9.0 | 3.5 | 5.0 | 0.5 | √ | √ | √ | √ |
| STE-07D151KS | 9.0 | 3.5 | 5.0 | 0.5 | √ | √ | √ | √ |
| STE-07D181KS | 9.0 | 4.0 | 5.0 | 0.5 | √ | √ | √ | √ |
| STE-07D201KS | 9.0 | 4.0 | 5.0 | 0.5 | √ | √ | √ | √ |
| STE-07D221KS | 9.0 | 4.5 | 5.0 | 0.5 | √ | √ | √ | √ |
| STE-07D241KS | 9.0 | 4.0 | 5.0 | 0.5 | √ | √ | √ | √ |
| STE-07D271KS | 9.0 | 4.0 | 5.0 | 0.5 | √ | √ | √ | √ |
| STE-07D301KS | 9.0 | 4.5 | 5.0 | 0.5 | √ | √ | √ | √ |
| STE-07D331KS | 9.0 | 4.5 | 5.0 | 0.5 | √ | √ | √ | √ |
| STE-07D361KS | 9.0 | 4.5 | 5.0 | 0.5 | √ | √ | √ | √ |
| STE-07D391KS | 9.0 | 5.0 | 5.0 | 0.5 | √ | √ | √ | √ |
| STE-07D431KS | 9.0 | 4.5 | 5.0 | 0.5 | √ | √ | √ | √ |
| STE-07D471KS | 9.0 | 4.5 | 5.0 | 0.5 | √ | √ | √ | √ |
| STE-07D511KS | 9.0 | 5.0 | 5.0 | 0.5 | √ | √ | √ | √ |
| STE-07D561KS | 9.0 | 5.0 | 5.0 | 0.5 | √ | √ | √ | √ |
| STE-07D621KS | 9.0 | 5.0 | 5.0 | 0.5 | √ | √ | √ | √ |
| STE-07D681KS | 9.0 | 5.5 | 5.0 | 0.5 | √ | √ | √ | √ |

10D-S Series

| Part No. | Size (mm) | | | | Approval | | | |
|--------------|-----------|--------|-------|--------|----------|-----|----------|--------------|
| | D Max. | T Max. | F±0.8 | d±0.05 | CQC | VDE | UL (USA) | cUL (Canada) |
| STE-10D180KS | 12.5 | 3.5 | 7.5 | 0.7 | | | √ | √ |
| STE-10D220KS | 12.5 | 3.5 | 7.5 | 0.7 | | | √ | √ |
| STE-10D270KS | 12.5 | 4.0 | 7.5 | 0.7 | | | √ | √ |
| STE-10D330KS | 12.5 | 4.0 | 7.5 | 0.7 | | | √ | √ |
| STE-10D390KS | 12.5 | 4.0 | 7.5 | 0.7 | | | √ | √ |
| STE-10D470KS | 12.5 | 4.0 | 7.5 | 0.7 | | | √ | √ |
| STE-10D560KS | 12.5 | 4.5 | 7.5 | 0.7 | | | √ | √ |
| STE-10D680KS | 12.5 | 5.0 | 7.5 | 0.7 | | | √ | √ |
| STE-10D820KS | 12.5 | 4.0 | 7.5 | 0.7 | √ | √ | √ | √ |
| STE-10D101KS | 12.5 | 4.0 | 7.5 | 0.7 | √ | √ | √ | √ |
| STE-10D121KS | 12.5 | 4.0 | 7.5 | 0.7 | √ | √ | √ | √ |
| STE-10D151KS | 12.5 | 4.5 | 7.5 | 0.7 | √ | √ | √ | √ |
| STE-10D181KS | 12.5 | 4.5 | 7.5 | 0.7 | √ | √ | √ | √ |
| STE-10D201KS | 12.5 | 4.5 | 7.5 | 0.7 | √ | √ | √ | √ |
| STE-10D221KS | 12.5 | 4.5 | 7.5 | 0.7 | √ | √ | √ | √ |
| STE-10D241KS | 12.5 | 4.5 | 7.5 | 0.7 | √ | √ | √ | √ |
| STE-10D271KS | 12.5 | 4.5 | 7.5 | 0.7 | √ | √ | √ | √ |
| STE-10D301KS | 12.5 | 5.0 | 7.5 | 0.7 | √ | √ | √ | √ |
| STE-10D331KS | 12.5 | 5.0 | 7.5 | 0.7 | √ | √ | √ | √ |
| STE-10D361KS | 12.5 | 5.0 | 7.5 | 0.7 | √ | √ | √ | √ |
| STE-10D391KS | 12.5 | 5.0 | 7.5 | 0.7 | √ | √ | √ | √ |
| STE-10D431KS | 12.5 | 5.0 | 7.5 | 0.7 | √ | √ | √ | √ |
| STE-10D471KS | 12.5 | 5.0 | 7.5 | 0.7 | √ | √ | √ | √ |
| STE-10D511KS | 12.5 | 5.5 | 7.5 | 0.7 | √ | √ | √ | √ |
| STE-10D561KS | 12.5 | 5.5 | 7.5 | 0.7 | √ | √ | √ | √ |
| STE-10D621KS | 12.5 | 5.5 | 7.5 | 0.7 | √ | √ | √ | √ |
| STE-10D681KS | 12.5 | 6.0 | 7.5 | 0.7 | √ | √ | √ | √ |
| STE-10D751KS | 12.5 | 6.0 | 7.5 | 0.7 | √ | √ | √ | √ |
| STE-10D781KS | 12.5 | 6.5 | 7.5 | 0.7 | | | √ | √ |
| STE-10D821KS | 12.5 | 6.5 | 7.5 | 0.7 | √ | √ | √ | √ |
| STE-10D911KS | 12.5 | 7.0 | 7.5 | 0.7 | √ | √ | √ | √ |
| STE-10D102KS | 12.5 | 7.5 | 7.5 | 0.7 | √ | √ | √ | √ |
| STE-10D112KS | 12.5 | 7.5 | 7.5 | 0.7 | √ | | √ | √ |

14D-S Series

| Part No. | Size (mm) | | | | Approval | | | |
|--------------|-----------|--------|-------|--------|----------|-----|----------|--------------|
| | D Max. | T Max. | F±0.8 | d±0.05 | CQC | VDE | UL (USA) | cUL (Canada) |
| STE-14D180KS | 16.5 | 3.5 | 7.5 | 0.7 | | | √ | √ |
| STE-14D220KS | 16.5 | 3.5 | 7.5 | 0.7 | | | √ | √ |
| STE-14D270KS | 16.5 | 4.0 | 7.5 | 0.7 | | | √ | √ |
| STE-14D330KS | 16.5 | 4.0 | 7.5 | 0.7 | | | √ | √ |
| STE-14D390KS | 16.5 | 4.0 | 7.5 | 0.7 | | | √ | √ |
| STE-14D470KS | 16.5 | 4.0 | 7.5 | 0.7 | | | √ | √ |
| STE-14D560KS | 16.5 | 4.5 | 7.5 | 0.7 | | | √ | √ |
| STE-14D680KS | 16.5 | 5.0 | 7.5 | 0.7 | | | √ | √ |
| STE-14D820KS | 16.5 | 4.0 | 7.5 | 0.7 | √ | √ | √ | √ |
| STE-14D101KS | 16.5 | 4.0 | 7.5 | 0.7 | √ | √ | √ | √ |
| STE-14D121KS | 16.5 | 4.0 | 7.5 | 0.7 | √ | √ | √ | √ |
| STE-14D151KS | 16.5 | 4.5 | 7.5 | 0.7 | √ | √ | √ | √ |
| STE-14D181KS | 16.5 | 4.5 | 7.5 | 0.7 | √ | √ | √ | √ |
| STE-14D201KS | 16.5 | 4.5 | 7.5 | 0.7 | √ | √ | √ | √ |
| STE-14D221KS | 16.5 | 4.5 | 7.5 | 0.7 | √ | √ | √ | √ |
| STE-14D241KS | 16.5 | 4.5 | 7.5 | 0.7 | √ | √ | √ | √ |
| STE-14D271KS | 16.5 | 4.5 | 7.5 | 0.7 | √ | √ | √ | √ |
| STE-14D301KS | 16.5 | 5.0 | 7.5 | 0.7 | √ | √ | √ | √ |
| STE-14D331KS | 16.5 | 5.0 | 7.5 | 0.7 | √ | √ | √ | √ |
| STE-14D361KS | 16.5 | 5.0 | 7.5 | 0.7 | √ | √ | √ | √ |
| STE-14D391KS | 16.5 | 5.0 | 7.5 | 0.7 | √ | √ | √ | √ |
| STE-14D431KS | 16.5 | 5.0 | 7.5 | 0.7 | √ | √ | √ | √ |
| STE-14D471KS | 16.5 | 5.0 | 7.5 | 0.7 | √ | √ | √ | √ |
| STE-14D511KS | 16.5 | 5.5 | 7.5 | 0.7 | √ | √ | √ | √ |
| STE-14D561KS | 16.5 | 5.5 | 7.5 | 0.7 | √ | √ | √ | √ |
| STE-14D621KS | 16.5 | 5.5 | 7.5 | 0.7 | √ | √ | √ | √ |
| STE-14D681KS | 16.5 | 6.0 | 7.5 | 0.7 | √ | √ | √ | √ |
| STE-14D751KS | 16.5 | 6.0 | 7.5 | 0.7 | √ | √ | √ | √ |
| STE-14D781KS | 16.5 | 6.5 | 7.5 | 0.7 | | | √ | √ |
| STE-14D821KS | 16.5 | 6.5 | 7.5 | 0.7 | √ | √ | √ | √ |
| STE-14D911KS | 16.5 | 7.0 | 7.5 | 0.7 | √ | √ | √ | √ |
| STE-14D102KS | 16.5 | 7.5 | 7.5 | 0.7 | √ | √ | √ | √ |
| STE-14D112KS | 16.5 | 7.5 | 7.5 | 0.7 | √ | | √ | √ |

20D-S Series

| Part No. | Size (mm) | | | | | Approval | | | |
|--------------|-----------|--------|-------|---------------|--------------|----------|-----|----------|--------------|
| | D Max. | T Max. | F±0.8 | d±0.05 | | CQC | VDE | UL (USA) | cUL (Canada) |
| | | | | Straight lead | Crimped lead | | | | |
| STE-20D180KS | 23.0 | 4.0 | 10.0 | 1.0 | 0.7 | | | √ | √ |
| STE-20D220KS | 23.0 | 4.0 | 10.0 | 1.0 | 0.7 | | | √ | √ |
| STE-20D270KS | 23.0 | 4.5 | 10.0 | 1.0 | 0.7 | | | √ | √ |
| STE-20D330KS | 23.0 | 4.5 | 10.0 | 1.0 | 0.7 | | | √ | √ |
| STE-20D390KS | 23.0 | 4.5 | 10.0 | 1.0 | 0.7 | | | √ | √ |
| STE-20D470KS | 23.0 | 5.0 | 10.0 | 1.0 | 0.7 | | | √ | √ |
| STE-20D560KS | 23.0 | 5.0 | 10.0 | 1.0 | 0.7 | | | √ | √ |
| STE-20D680KS | 23.0 | 5.5 | 10.0 | 1.0 | 0.7 | | | √ | √ |
| STE-20D820KS | 23.0 | 4.0 | 10.0 | 1.0 | 0.7 | √ | √ | √ | √ |
| STE-20D101KS | 23.0 | 4.5 | 10.0 | 1.0 | 0.7 | √ | √ | √ | √ |
| STE-20D121KS | 23.0 | 4.5 | 10.0 | 1.0 | 0.7 | √ | √ | √ | √ |
| STE-20D151KS | 23.0 | 5.0 | 10.0 | 1.0 | 0.7 | √ | √ | √ | √ |
| STE-20D181KS | 23.0 | 5.0 | 10.0 | 1.0 | 0.7 | √ | √ | √ | √ |
| STE-20D201KS | 23.0 | 5.0 | 10.0 | 1.0 | 0.7 | √ | √ | √ | √ |
| STE-20D221KS | 23.0 | 5.5 | 10.0 | 1.0 | 0.7 | √ | √ | √ | √ |
| STE-20D241KS | 23.0 | 5.0 | 10.0 | 1.0 | 0.7 | √ | √ | √ | √ |
| STE-20D271KS | 23.0 | 5.0 | 10.0 | 1.0 | 0.7 | √ | √ | √ | √ |
| STE-20D301KS | 23.0 | 5.5 | 10.0 | 1.0 | 0.7 | √ | √ | √ | √ |
| STE-20D331KS | 23.0 | 5.5 | 10.0 | 1.0 | 0.7 | √ | √ | √ | √ |
| STE-20D361KS | 23.0 | 5.5 | 10.0 | 1.0 | 0.7 | √ | √ | √ | √ |
| STE-20D391KS | 23.0 | 5.5 | 10.0 | 1.0 | 0.7 | √ | √ | √ | √ |
| STE-20D431KS | 23.0 | 5.5 | 10.0 | 1.0 | 0.7 | √ | √ | √ | √ |
| STE-20D471KS | 23.0 | 5.5 | 10.0 | 1.0 | 0.7 | √ | √ | √ | √ |
| STE-20D511KS | 23.0 | 6.0 | 10.0 | 1.0 | 0.7 | √ | √ | √ | √ |
| STE-20D561KS | 23.0 | 6.0 | 10.0 | 1.0 | 0.7 | √ | √ | √ | √ |
| STE-20D621KS | 23.0 | 6.5 | 10.0 | 1.0 | 0.7 | √ | √ | √ | √ |
| STE-20D681KS | 23.0 | 6.5 | 10.0 | 1.0 | 0.7 | √ | √ | √ | √ |
| STE-20D751KS | 23.0 | 7.0 | 10.0 | 1.0 | 0.7 | √ | √ | √ | √ |
| STE-20D781KS | 23.0 | 7.0 | 10.0 | 1.0 | 0.7 | | | √ | √ |
| STE-20D821KS | 23.0 | 7.0 | 10.0 | 1.0 | 0.7 | √ | √ | √ | √ |
| STE-20D911KS | 23.0 | 7.5 | 10.0 | 1.0 | 0.7 | √ | √ | √ | √ |
| STE-20D102KS | 23.0 | 8.0 | 10.0 | 1.0 | 0.7 | √ | √ | √ | √ |
| STE-20D112KS | 23.0 | 8.0 | 10.0 | 1.0 | 0.7 | √ | | √ | √ |

Lead Configuration

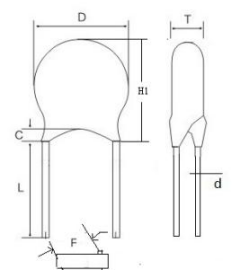
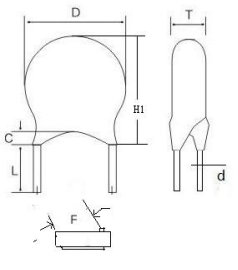
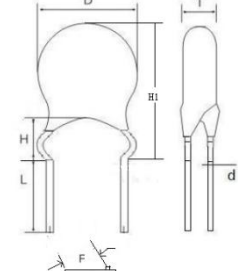
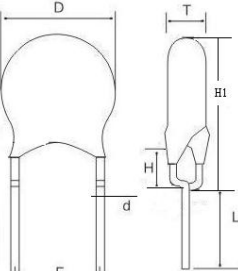
| Lead Style | Drawing | Lead Length L (mm) | Coating Lead Length C (mm) | Height H (mm) |
|------------------|---|--|----------------------------|---------------|
| Long Straight |  | 16.0 min | 3.0 Max | / |
| Short Straight |  | ①[2.5≤L < 6.0]±0.5; ②[6.0≤L≤10]±1.0 | 3.0 Max | / |
| Outside Crimped |  | ①[2.5≤L < 6.0]±0.5; ②[6.0≤L≤10]±1.0 | Not exceed the bend point | 5.5mm Max |
| Vertical Crimped |  | ①[2.5≤L < 6.0]±0.5; ②[6.0≤L≤10]±1.0 | Not exceed the bend point | 4.5mm Max |

Taping And Dimensions (mm)

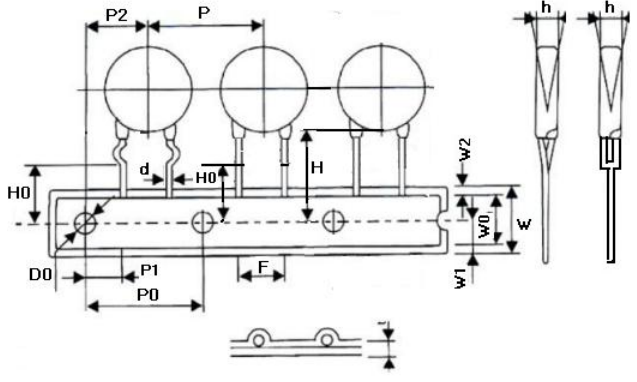
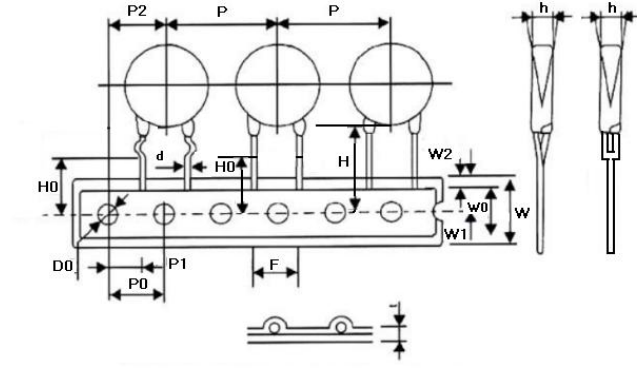
| Figure | Fig.1 | | Fig.2 | | | | |
|---|--|-----------------------------|-----------------------------|-----------------------------|--------------|---------------|--------------|
| | Symbol | P=5.0 | P=7.5 | | P=10.0 | | |
|  <p>Fig.1 (P=5.0)</p> | Po | 12.7±0.3 | 12.7±0.3 | 12.7±0.3 | | | |
| | P | 12.7±1.0 | 25.4±1.0 | 25.4±1.0 | | | |
| | P1 | 3.85±0.7 | 8.95±0.7 | 7.7±0.7 | | | |
| | P2 | 6.35±1.3 | 12.7±1.3 | 12.7±1.3 | | | |
| | F | 5±0.8 | 7.5±0.8 | 10.0±0.8 | | | |
| | Δh | 0±2.0 | 0±2.0 | 0±2.0 | | | |
| | W | 18.0+1.5/-1.0 | 18.0 +1.5/-1.0 | 18.0 +1.5/-1.0 | | | |
| | Wo | 10.5 Max | 10.5 Max | 10.5 Max | | | |
| | W1 | 9.0+0.75/-0.5 | 9.0+0.75/-0.5 | 9.0+0.75/-0.5 | | | |
| |  <p>Fig.2 (P=7.5 & 10)</p> | W2 | 3.0 Max | 3.0 Max | 3.0 Max | | |
| Do | | 4.0±0.2 | 4.0±0.2 | 4.0±0.2 | | | |
| H | | 20+1.5/-1.0 | 20+1.5/-1.0 | 20+1.5/-1.0 | | | |
| Ho | | 16.5&17.0&19.0 +1.5/-1.0 | 16.5&17.0&19.0 +1.5/-1.0 | 16.5&17.0&19.0 +1.5/-1.0 | | | |
| L | | Straight Lead | Crimped Lead | Straight Lead | Crimped Lead | Straight Lead | Crimped Lead |
| | | 11.0 Max | 9.0 Max | 11.0 Max | 9.0 Max | 11.0 Max | 9.0 Max |
| t1 | | 0.5±0.2 | 0.5±0.2 | 0.5±0.2 | | | |
| t2 | | 1.7 Max | 1.7 Max | 1.7 Max | | | |

X-ON Electronics

Largest Supplier of Electrical and Electronic Components

Click to view similar products for [Varistors](#) category:

Click to view products by [Songtian](#) manufacturer:

Other Similar products are found below :

[820443211E](#) [MOV05131AIA](#) [MOV07231AQA](#) [MOV18131CZA](#) [R71ZOV151HC](#) [D58ZOV500RA01T1](#) [B72205S271K111](#)
[B72214S251K151](#) [B72280B271K1](#) [B72650M0151K093](#) [B72660M0271K093](#) [NTE1V020](#) [NTE1V130](#) [NTE2V010](#) [NTE2V130](#)
[238159352716](#) [25FN511K](#) [S10K11G5S5](#) [ERZ-C14DK361U](#) [ERZ-C20DK221U](#) [ERZ-C32CK201B](#) [207869-1](#) [AS-13](#) [TMOV25SP625E](#)
[TND10V-471KB00AAA0](#) [B72280B112K1](#) [B72280B381K1](#) [B72590D360A60](#) [B72650M301K93](#) [B72670M1140K72](#) [MOV07251ARA](#)
[MOV10131EDA](#) [MOV10151EFA](#) [MOV14151CWA](#) [MOV20251DFA](#) [TVZ18EC271KBS](#) [TVZ20EB911KBS](#) [TVZ25D201KBS](#)
[TVZ25D241KBS](#) [VDRH20X230BSE](#) [VZ07D220KBS](#) [VZ40D241K](#) [VZ25D511KBS-N](#) [VZ20E511KBSX](#) [VZ20E221KBSX](#)
[VZ10D471KBS-N](#) [ERZ-V20R201](#) [ERZ-V20R221](#) [B72240B681K1](#) [B72510E140K62](#)