

SNZB-06P(EN)



Zigbee Human Presence Sensor

User Manual V1.0

Introduction

SNZB-06P is a human-presence sensor based on 5.8G microwave technology, which realizes the human-presence sensing function by actively detecting ambient motion and human breath. It effectively avoids the embarrassing scene where the light automatically off when people are on the spot, making your home life smarter.



Microwave radar



Presence detection



Light sensing



Intelligent linkage

*The functional characteristics depend on the functionality of Zigbee gateway.

*The equipment is only suitable for mounting at heights ≤ 2 m.

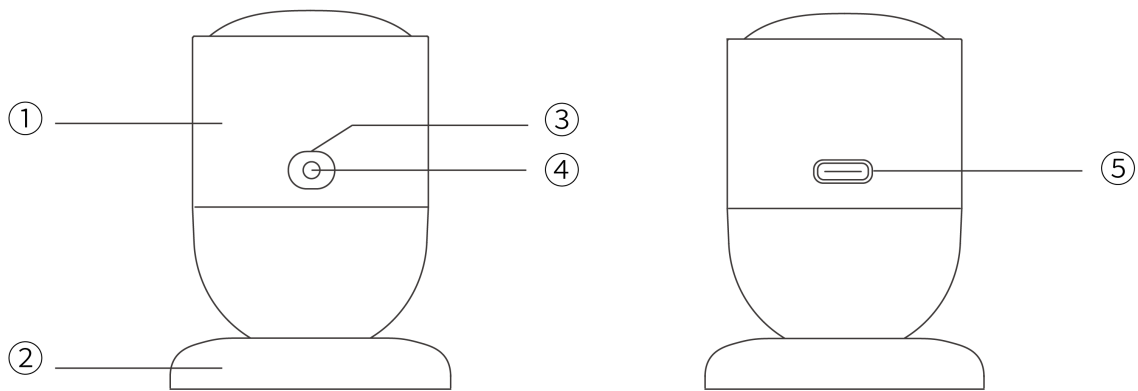

① Human presence sensor	② Magnetic base	③ Button
④ LED indicator (Red)	⑤ Power input interface (Type-C)	

Instruction of LED indicator status

LED indicator status	Status instruction
Flash slowly for 180 seconds	First-time power on/press and hold button for 5s to enter pairing mode
Keep on for 3s and then keep off	Paired successfully
Exit flashing slowly and keep off	Distribution failure/timeout
Flash once quickly	Not added to the gateway, and short press the button
Flash twice quickly	Added to the gateway and online, and short press the button
Flash slowly for 30 seconds	Abnormal communication

Specification

Model	SNZB-06P
MCU	EFR32MG22
Input	5V  1A
Interface type	Type-C
Colour	White
Product dimension	44.2x44.2x59mm
Net weight	31g
Casing materials	PC+ABS
Wireless connection	Zigbee 3.0 (IEEE802.15.4)
Pairing time	180s
Communication distance	Indoor environment 30m
Applicable place	Indoor
Working temperature	-10°C ~ 60°C
Working humidity	0~90%RH, non-condensing
Working height	Less than 5000m
Certification	CE/FCC/ISED/RoHS
Executive standard	EN IEC 62368-1

Download the eWeLink App & Add SONOFF Zigbee gateway.

Please download the "eWeLink" App from [Google Play Store](#) or [Apple App Store](#).

Scan QR Code to Add Device

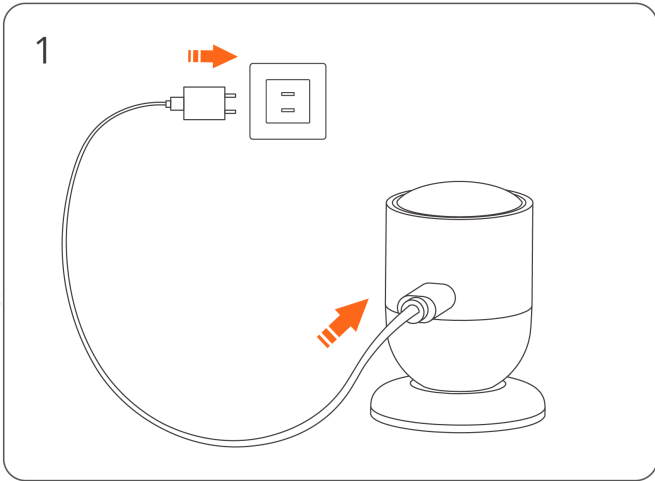

Power on the device

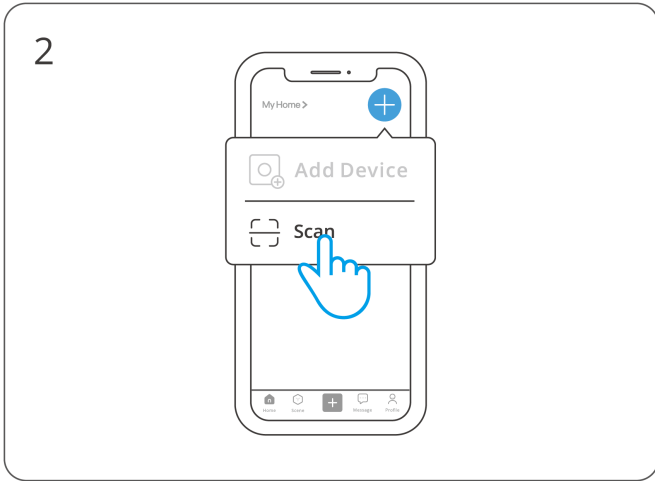

Enter "scan QR code" mode

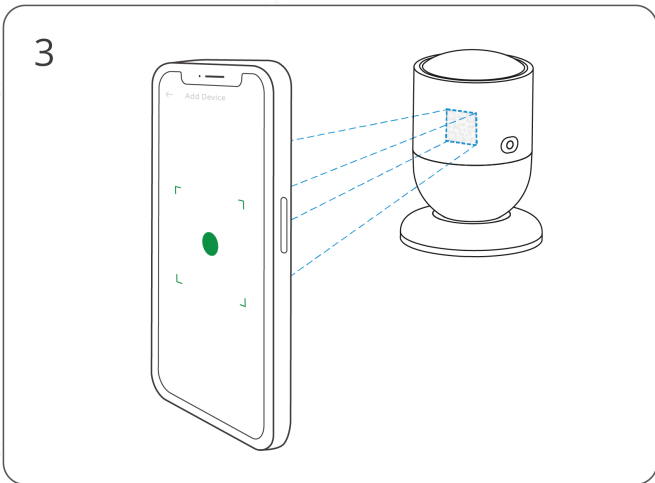

Scan the QR code on the device

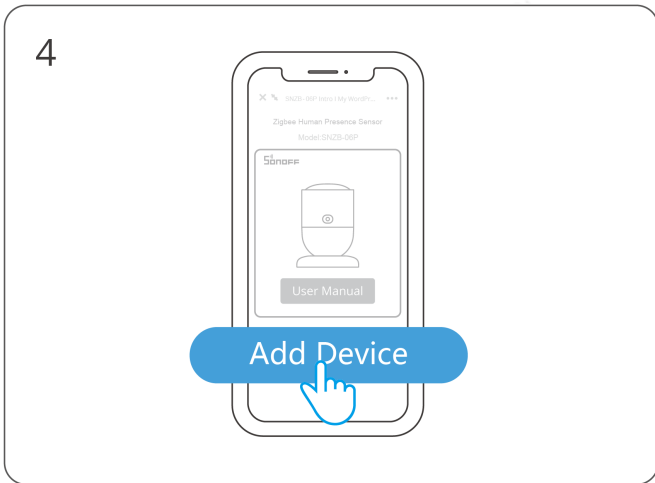

Select "Add Device"

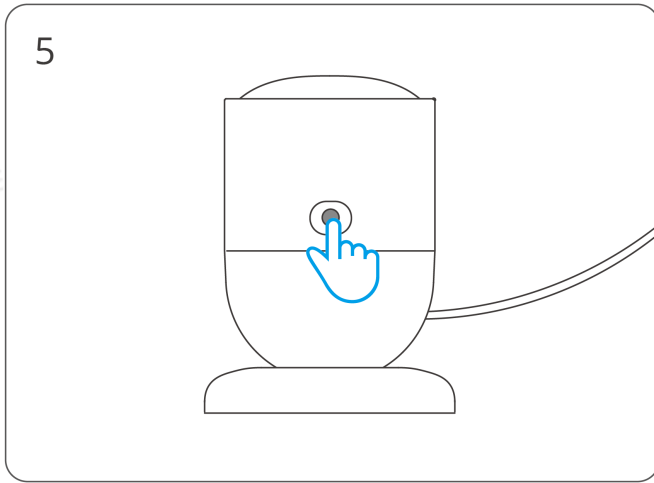

Long press the button for 5 seconds

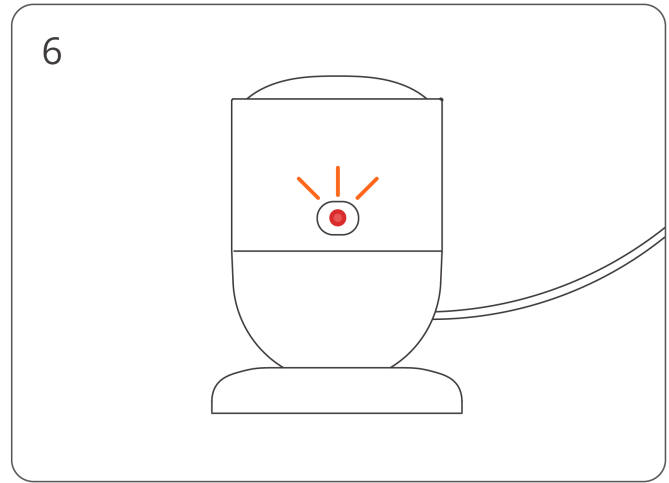

The LED indicator flashes slowly for 180s

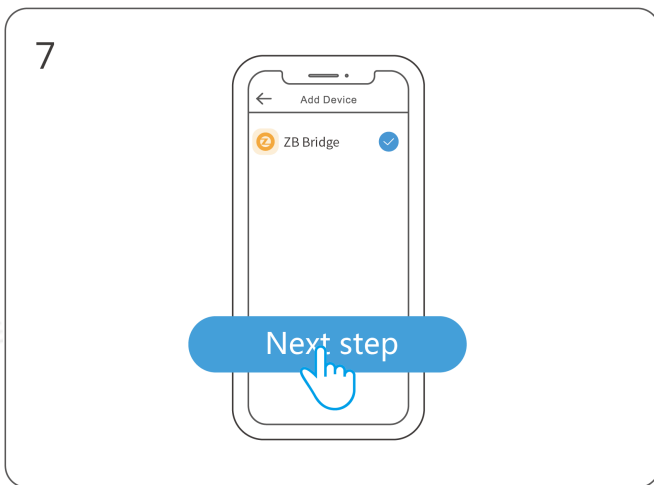

Select Zigbee gateway

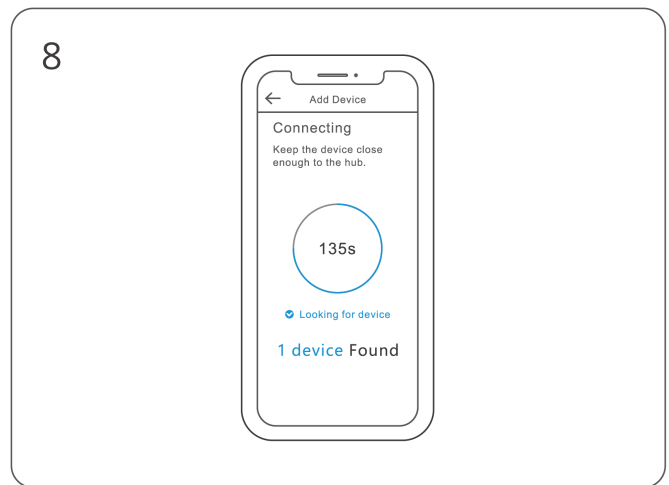

Wait until the addition is done

Matched gateways

SONOFF ZBBridge, ZBBridge-P, NSPanel PRO, AIBridge, ZBDongel-P, ZBDongel-E

Third-party compatible gateway models:

Amazon Gateway Model: Echo Plus 2nd, Echo Show 2nd

Other gateways supporting ZigBee3.0 wireless protocol. Detailed information is in accordance with the final product.

*Displays as a human motion sensor under some gateways.

Effective Communication Distance Verification

Install the device in the desired place, then press the Pairing button on the device. The LED indicator flashes twice means the device and the device under the same Zigbee network (the router device or hub) are in the effective communication distance.

Installation

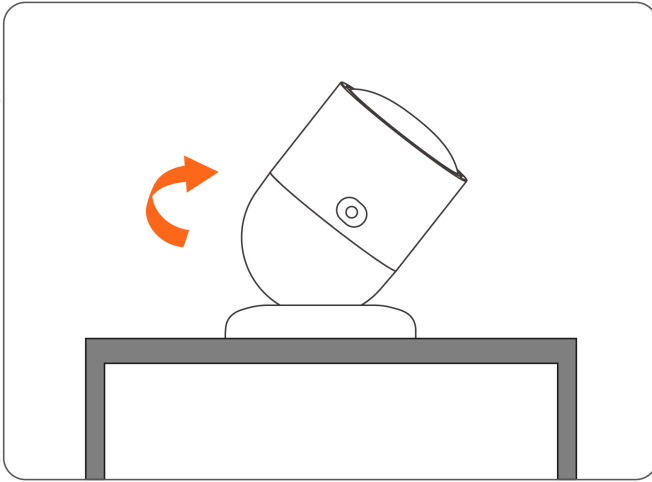

1. Place on the desktop

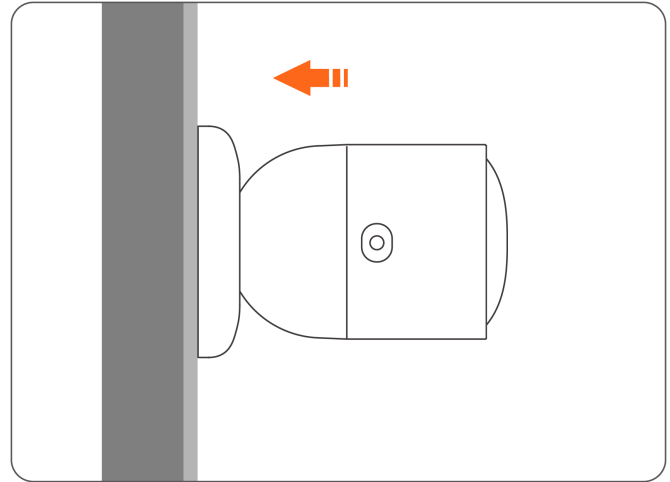

2. Attached to the metal surface with the magnetic base

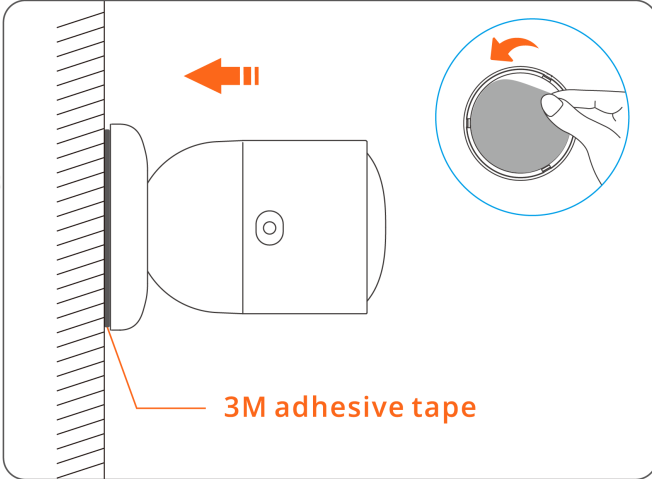

3. Stick to the wall with 3M adhesive of the base

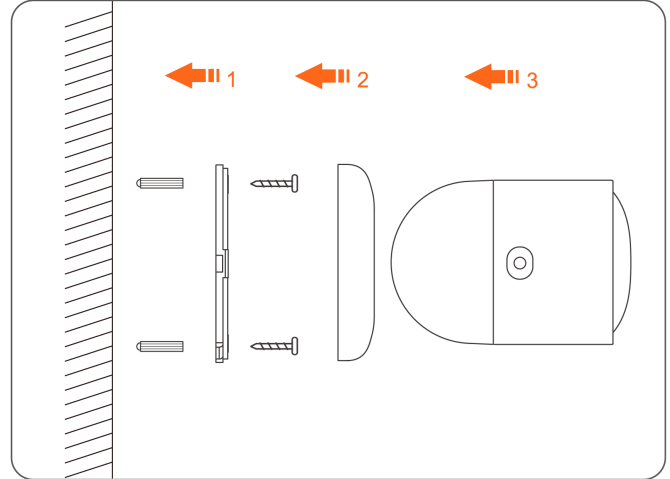

4. Base screws fixed to the wall

Detection zone

The radar's radial detection distance is approximately 4 meters.

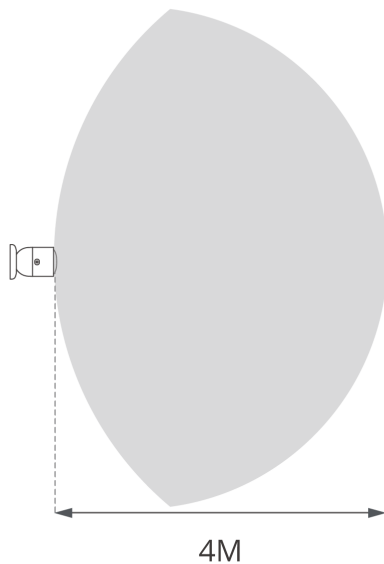

Cautions

1. Keep off moving objects including such as curtains, greenery, fans and pets during installation to avoid the device's misjudgment that there are persons nearby.
2. Non-metallic materials including such as glass, plastic, ceramics and plank can be pierced through.
3. Multiple sensors should be installed in the same direction or back-to-back, avoiding front-to-front irradiation, and each sensor should be more than 1.5 meter away from others.

FCC Warning

FCC compliance statement

1. This device complies with part 15 of the FCC Rules. Operation is subject to the following two conditions:
 - (1) This device may not cause harmful interference, and
 - (2) This device must accept any interference received, including interference that may cause undesired operation.
2. Changes or modifications not expressly approved by the party responsible for compliance could void the user's authority to operate the equipment.

Note: This equipment has been tested and found to comply with the limits for a Class B digital device, pursuant to part 15 of the FCC Rules. These limits are designed to provide reasonable protection against harmful interference in a residential installation. This equipment generates, uses and can radiate radio frequency energy and, if not installed and used in accordance with the instructions, may cause harmful interference to radio communications. However, there is no guarantee that interference will not occur in a particular installation. If this equipment does cause harmful interference to radio or television reception, which can be determined by turning the equipment off and on, the user is encouraged to try to correct the interference by one or more of the following measures:

- Reorient or relocate the receiving antenna.
- Increase the separation between the equipment and receiver.
- Connect the equipment into an outlet on a circuit different from that to which the receiver is connected.
- Consult the dealer or an experienced radio/TV technician for help.

FCC Radiation Exposure statement:

This equipment complies with FCC radiation exposure limits set forth for an uncontrolled environment.

This equipment should be installed and operated with minimum distance of 20 cm between the radiator and your body.

This transmitter must not be co-located or operating in conjunction with any other antenna or transmitter.

ISED Notice

ISED Notice

This device contains licence-exempt transmitter(s)/receiver(s) that comply with Innovation, Science and Economic Development Canada's licence-exempt RSS(s). Operation is subject to the following two conditions:

- (1) This device may not cause interference.
- (2) This device must accept any interference, including interference that may cause undesired operation of the device.

This Class B digital apparatus complies with Canadian ICES-003(B).

This device complies with RSS-247 of Industry Canada. Operation is subject to the condition that

this device does not cause harmful interference.

L'émetteur/récepteur exempt de licence contenu dans le présent appareil est conforme aux CNR d'Innovation, Sciences et Développement économique Canada applicables aux appareils radio exempts de licence. L'exploitation est autorisée aux deux conditions suivantes :

(1) L'appareil ne doit pas produire de brouillage;

(2) L'appareil doit accepter tout brouillage radioélectrique subi, même si le brouillage est susceptible d'en compromettre le fonctionnement.

Cet appareil numérique de la Classe B conforme à la norme NMB-003(B) du Canada.

Cet appareil est conforme à la norme RSS - 247 d'Industrie Canada. Le fonctionnement est soumis à la condition que cet appareil ne provoque pas d'interférences nuisibles.

ISED Radiation Exposure Statement

This equipment complies with ISED radiation exposure limits set forth for an uncontrolled environment.

This equipment should be installed and operated with minimum distance of 20 cm between the radiator and your body.

This transmitter must not be co-located or operating in conjunction with any other antenna or transmitter.

Cet équipement est conforme aux limites d'exposition aux rayonnements de la ISED établies pour un environnement non contrôlé.

Cet équipement doit être installé et fonctionner à au moins 20cm de distance d'un radiateur ou de votre corps.

Cet émetteur ne doit pas être co-localisé ou fonctionner en conjonction avec une autre antenne ou un autre émetteur.

SAR Warning

Under normal use of condition, this equipment should be kept a separation distance of at least 20 cm between the antenna and the body of the user.

Dans des conditions normales d'utilisation, cet équipement doit être maintenu à une distance d'au moins 20 cm entre l'antenne et le corps de l'utilisateur.

WEEE Warning



WEEE Disposal and Recycling Information

All products bearing this symbol are waste electrical and electronic equipment (WEEE as in directive 2012/19/EU) which should not be mixed with unsorted household waste. Instead, you should protect human health and the environment by handing over your waste equipment to a designated collection point for the recycling of waste electrical and electronic equipment, appointed by the government or local authorities. Correct disposal and recycling will help prevent potential negative consequences to the environment and human health. Please contact the installer or local authorities for more information about the location as well as terms and conditions of such collection points.

EU Declaration of Conformity

Hereby, Shenzhen Sonoff Technologies Co., Ltd declares that the radio equipment type SNZB-06P is in compliance with Directive 2014/53/EU. The full text of the EU declaration of conformity is available at the following internet address:

<https://sonoff.tech/compliance/>

For CE frequency

Zigbee: 2405–2480MHz

FMCW: 5725–5875MHz

RF Output Power:

Zigbee: ≤10dBm

FMCW: ≤10dBm

Scatola	Manuale	Borsa	Borsa
PAP 21	PAP 22	CPE7	LDPE4
Carta	Carta	Plastica	Plastica
RACCOLTA DIFFERENZIATA			

Verifica le disposizioni del tuo Comune.

Separa le componenti e conferiscile in modo corretto.



Manufacturer: Shenzhen Sonoff Technologies Co., Ltd.

Address: 3F & 6F, Bldg A, No. 663, Bulong Rd, Shenzhen, Guangdong, China

ZIP code: 518000

Service email: support@itead.cc

Website: sonoff.tech

Made in China



X-ON Electronics

Largest Supplier of Electrical and Electronic Components

Click to view similar products for [Specialist Controllers](#) category:

Click to view products by [Sonoff](#) manufacturer:

Other Similar products are found below :

[CV500SLK21](#) [H2CRSAC110B](#) [R88ARR080100S](#) [E53E01](#) [E53E8C](#) [E5GNQ03PFLKACDC24](#) [B300LKL21](#) [NSCXDC1V3](#)
[NT20SST122BV1](#) [C40PEDRA](#) [K31S5](#) [K31S6](#) [K3TX-AD31A](#) [L595020](#) [26546803](#) [26546805](#) [H7HP-C8D](#) [PWRA440A](#) [CPM1AETL03CH](#)
[3G2A5BI081](#) [3G2A5IA122](#) [3G2A5OD211](#) [3G2A5RM001EV1](#) [3G2A5RT002EV1](#) [3G2A6-ID217](#) [3G2A6LK202EV1](#) [3G2A9AL004E](#)
[C200HETL01E](#) [C200PCPD024](#) [3G2A5AD001](#) [3G2A5BI051](#) [3G2A5IA121](#) [3G2A5ID112](#) [3G2A5ID213](#) [3G2A5ID219](#) [3G2A5MR431](#)
[3G2A5OC221](#) [3G2A5PS222E](#) [3G2A6IM213](#) [3G2A6-OD412](#) [3G2A9AL001](#) [3G2C7LK202EV1](#) [3G5A2OC221E](#) [LDP2TA2B115](#)
[3G3DV130B4294](#) [E53E04](#) [E53Q4Q4](#) [E54E8CT](#) [C200HWCOM06EV1](#) [NT30KBA04](#)