

SOREDE

索 瑞 達 電 子

深圳市索瑞达电子有限公司

承 认 书

SPECIFICATION FOR APPROVAL

客户名称: 立创
Customer Name : _____

客户料号:
Customer P/N: _____

产品名称: 功率电感
Product Name: _____

索瑞达料号: SCD.5845.DYF122KT00
Sorede P/N: _____

制造厂商 Manufacturer	
拟制 Draft	唐杨英
审核 Check	符妃团 工程专用章
日期 Date	2023-03-30

客户承认印章 Approval Signet	
日期 Date	

地址: 深圳市观澜镇福城街道新塘村8号源创园陆号A6栋3楼.

Address: 3Rd Floor, Building A6, Yuanchuangyuanlu, No. 8 Xintang Village, Fucheng Street, Guanlan Town, Shenzhen.

电话 Tel: 0755-29803356 传真 Fax: 0755-29803506

电子邮件 E-mail: sorde@vip.163.com

网址 [http:// www.szsorede.com](http://www.szsorede.com)

文件编号 File Number	SRD-WI-3657	版本号 Version Number	A	页码 page	1/8
---------------------	-------------	-----------------------	---	------------	-----

1、外形尺寸 Dimension :

单位Unit: mm

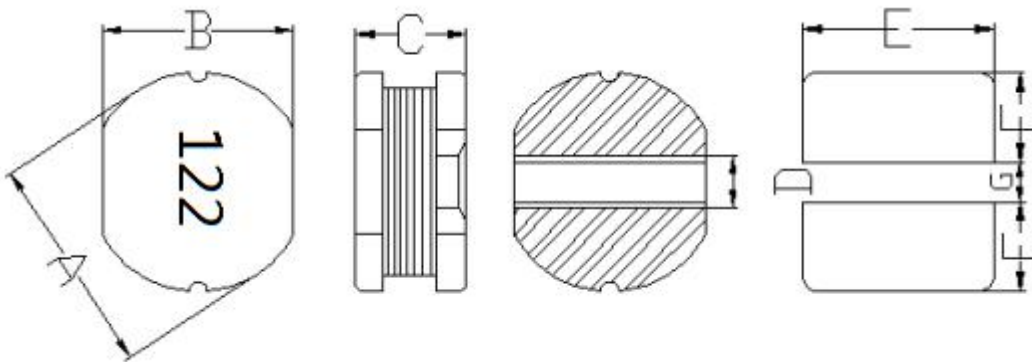

A	5.8±0.3
B	5.2±0.3
C	4.5±0.3
D	1.6Ref.
E	5.8Ref.
F	2.2Ref.
G	1.6Ref.

2、产品品名构成 Product Spec. Model

SCD . 5845 . D Y F 122 K T 00
a b c d e f g h i

▶ Lettering direction

- a: 系列名称 Series name
- b: 产品尺寸 Product dimensions (A x B x C)
- c: 绕组 (D:单线 Single Line、C: 双线 Double Line)
- d: 密封方式 Sealing way (L: 冷封 Cold seal Y: 热封 Heat seal)
- e: 印字方向 Lettering direction ▶
- f: 电感值 Inductance Value
(1R0:1.0uH; 100: 10uH; 101:100uH)
- g: 电感公差 Inductance Tolerance (K:10% ; M:20% ; N:30%)
- h: 包装 Package (T:磁带/卷轴 Tape/Reel、B: 散装 Bulk)
- i: 编号 Numbering (标准 standard)

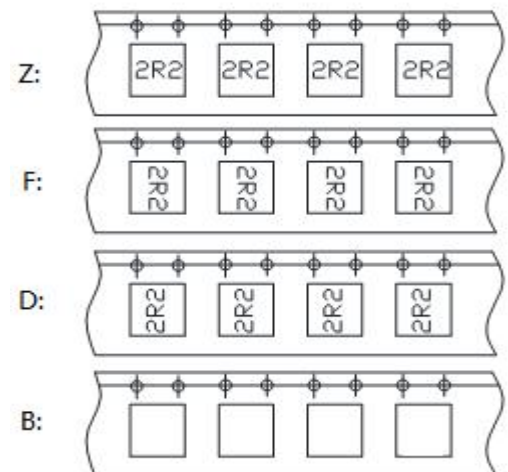

3、结构 Structure



4、材料清单 MATERIAL LIST

NO.	PARTS	MATERIAL	UL FILE NO.	TEMP. CLASS
1	CORE	Ni-Zn CORE OR EQUIVALENT	NA	NA
2	WIRE	POLYURETHANE ENAMELLED COPPER WIRE OR EQUIVALENT	E258243	180°C
3	SOLDER	Sn99.3-Cu0.7 OR EQUIVALENT	NA	NA

*NA:NOT APPLICABLE.

6、产品包装 Packaging

1) 载带包装示意图 Tape packing diagram

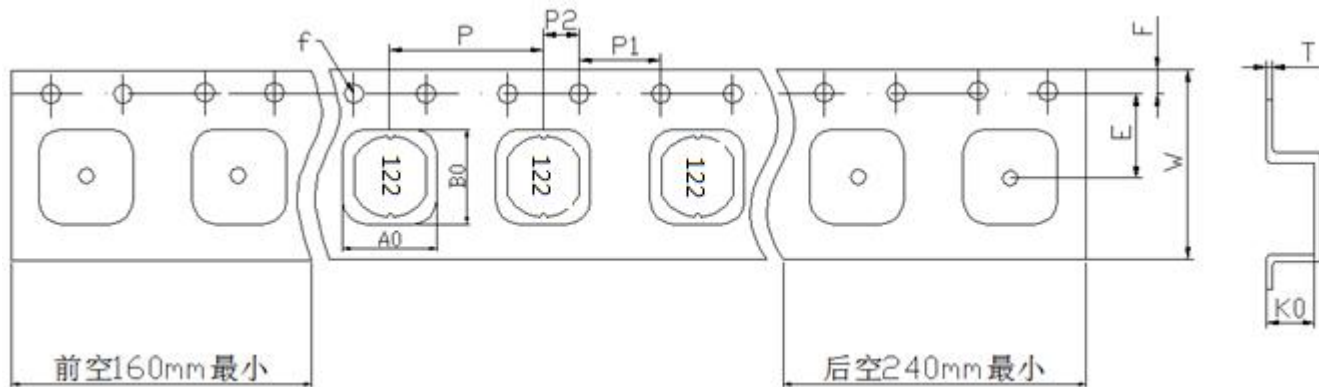

ITEM	W	A0	B0	K0	P	E	F	D0	P0	P2	T
DIM	12.00	5.90	5.40	4.80	8.00	5.50	1.75	1.50	4.00	2.00	0.40
TOLE	±0.3	±0.1	±0.1	±0.1	±0.1	±0.1	±0.1	+0.1	±0.1	±0.1	±0.05

2) 卷盘包装示意图 Tape packing diagram

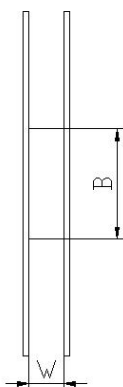
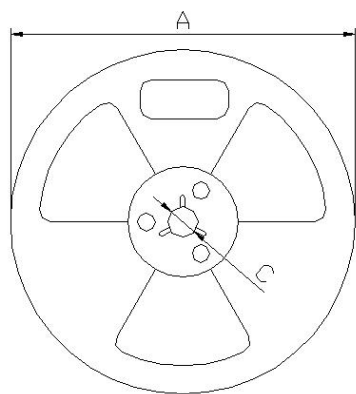

A	330±0.5
B	100±0.5
C	13.5±0.5
W	12.5±0.5

3) 卷盘包装示意图 Tape packing diagram

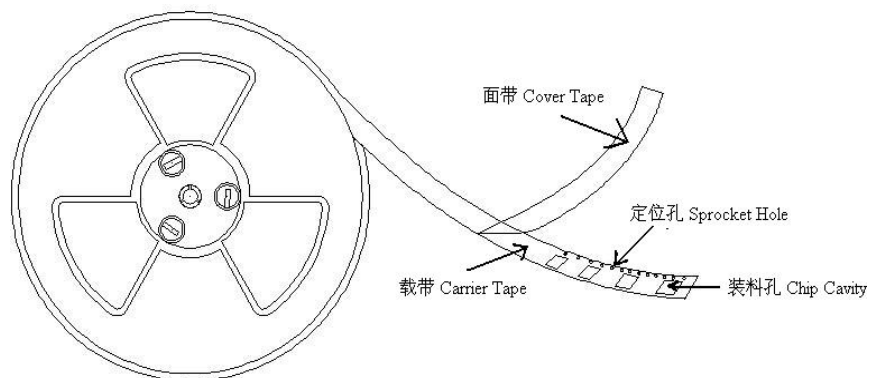

4) 剥离强度要求 Peeling required

① F 力大小: 20~100g;

② 面带剥离角度: 165°~180°。

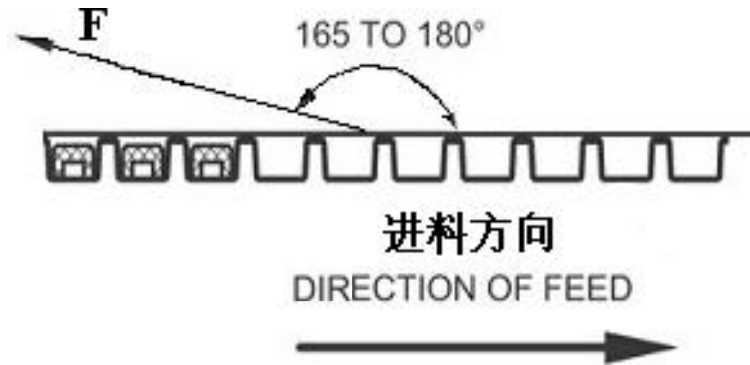

5) 包装数量 Packing quantity

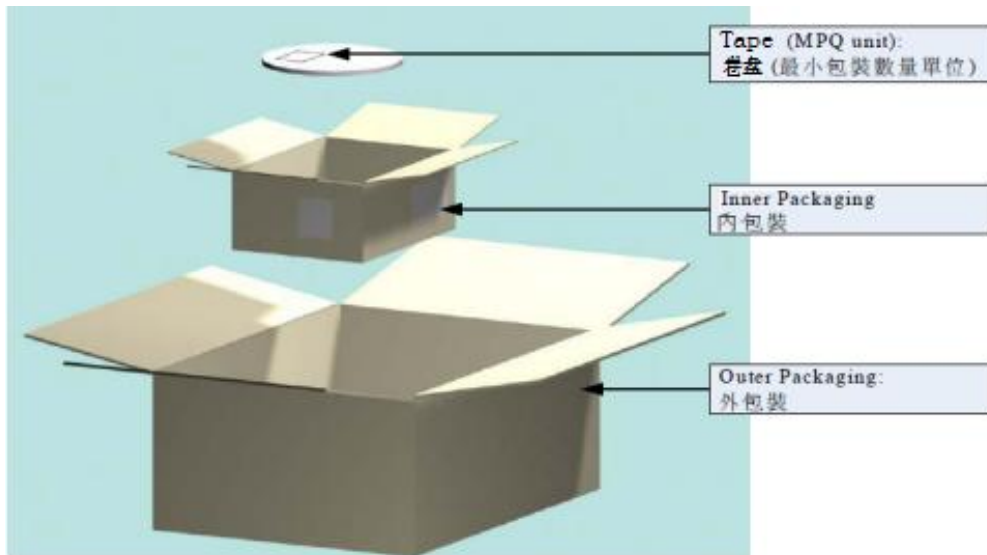

项目 (Project)	数量 (PCS)	尺寸规格 (Size:mm)
盘(Reel)	1500	13"
内盒 (Inner box)	6000	340mm*340mm*65mm
外箱 (Out box)	18000	360mm*360mm*235mm

7.RELIABILITY TEST METHOD

MECHANICAL

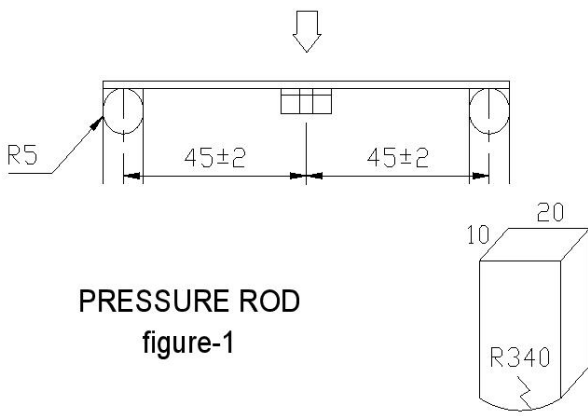
TEST ITEM	SPECIFICATION	TEST DETAILS
Substrate bending	$\Delta L/L_0 \leq \pm 5\%$ There shall be no mechanical damage or electrical damage.	<p>The sample shall be soldered onto the printed circuit board in figure 1 and a load applied until the figure in the arrow direction is made approximately 3mm.(keep time 30 seconds) PCB dimension shall the page 7/9</p> <p style="text-align: center;">F(Pressurization)</p>  <p style="text-align: center;">PRESSURE ROD figure-1</p>
Vibration	$\Delta L/L_0 \leq \pm 5\%$ There shall be no mechanical damage.	<p>The sample shall be soldered onto the printed circuit board and when a vibration having an amplitude of 1.52mm and a frequency of from 10 to 55Hz/1 minute repeated should be applied to the 3 directions (X,Y,Z) for 2 hours each. (A total of 6 hours)</p>
Solderability	New solder More than 90%	<p>Flux (rosin, isopropyl alcohol{JIS-K-1522}) shall be coated over the whole of the sample before hard, the sample shall then be preheated for about 2 minutes in a temperature of 130~150°C and after it has been immersed to a depth 0.5mm below for 3±0.2 seconds fully in molten solder M705 with a temperature of 245±2°C .</p> <p>More than 90% of the electrode sections shall be covered with new solder smoothly when the sample is taken out of the solder bath.</p>

MECHANICAL

TEST ITEM	SPECIFICATION	
Resistance to Soldering heat (reflow soldering)	There shall be no damage or problems.	<p style="text-align: center;">Temperature profile of reflow soldering</p> <p>The specimen shall be passed through the reflow oven with the condition shown in the above profile for 1 time.</p> <p>The specimen shall be stored at standard atmospheric conditions for 1 hour, after which the measurement shall be made.</p>

ELECTRICAL

TEST ITEM	SPECIFICATION	TEST DETAILS
Insulation resistance	There shall be no other damage or problems.	DC 100V voltage shall be applied across this sample of top surface and the terminal. The insulation resistance shall be more than $1 \times 10^8 \Omega$.
Dielectric withstand voltage	There shall be no other damage or problems.	AC 100V voltage shall be applied for 1 minute across the top surface and the terminal of this sample
Temperature characteristics	$\Delta L/L 20^\circ\text{C} \leq \pm 10\%$ $0 \sim 2000 \text{ ppm}/^\circ\text{C}$	The test shall be performed after the sample has stabilized in an ambient temperature of -40 to $+105^\circ\text{C}$, and the value calculated based on the value applicable in a normal temperature and normal humidity shall be $\Delta L/L 20^\circ\text{C} \leq \pm 10\%$.

文件编号 File Number	SRD-WI-3657	版本号 Version Number	A	页码 page	7/8
---------------------	-------------	-----------------------	---	------------	-----

ENVIROMENT CHARACTERISTICS

TEST ITEM	SPECIFICATION																
High temperature storage	$\Delta L/Lo \leq \pm 5\%$ There shall be no mechanical damage.	The sample shall be left for 500hours in an atmospere with a temperature of $105 \pm 2^\circ\text{C}$ and a normal humidity. Upon completion of the measurement shall be made after the sample has been left in a normal temperature and normal humidity for 1 hour.															
Low temperature storage	$\Delta L/Lo \leq \pm 5\%$ There shall be no mechanical damage.	The sample shall be left for 500 hours in an atmosphere with a temperature of $-40 \pm 3^\circ\text{C}$. Upon completion of the test, the measurement shall be made after the sample has been left in a normal temperature and normal humidity for 1 hour.															
Change of temperature	$\Delta L/Lo \leq \pm 5\%$ There shall be no other damage of problems	The sample shall be subject to 5 continuos cycles, such as shown in the table 2 below and then it shall be subjected to standard stmospheric conditions for 1 hour, after which measurement shall be made. <div style="text-align: center;">table 2</div> <table border="1" style="margin-left: auto; margin-right: auto;"> <thead> <tr> <th></th> <th>Temperature</th> <th>Duration</th> </tr> </thead> <tbody> <tr> <td>1</td> <td>$-40 \pm 3^\circ\text{C}$ (Thermostat No.1)</td> <td>10 min.</td> </tr> <tr> <td>2</td> <td>Standard atmospheric</td> <td>5 sec. or less No.1→No.2</td> </tr> <tr> <td>3</td> <td>$105 \pm 2^\circ\text{C}$ (Thermostat No.2)</td> <td>30 min.</td> </tr> <tr> <td>4</td> <td>Standard atmospheric</td> <td>5 sec. or less No.2→No.1</td> </tr> </tbody> </table>		Temperature	Duration	1	$-40 \pm 3^\circ\text{C}$ (Thermostat No.1)	10 min.	2	Standard atmospheric	5 sec. or less No.1→No.2	3	$105 \pm 2^\circ\text{C}$ (Thermostat No.2)	30 min.	4	Standard atmospheric	5 sec. or less No.2→No.1
	Temperature	Duration															
1	$-40 \pm 3^\circ\text{C}$ (Thermostat No.1)	10 min.															
2	Standard atmospheric	5 sec. or less No.1→No.2															
3	$105 \pm 2^\circ\text{C}$ (Thermostat No.2)	30 min.															
4	Standard atmospheric	5 sec. or less No.2→No.1															
Moisuture storage	$\Delta L/Lo \leq \pm 5\%$ There shall be no mechanical damage.	The sample shall be left for 500 hours in a temperature of $40 \pm 2^\circ\text{C}$ and a humidity(RH) of 90~95%. Upon completion of the test, the measurement shall be made after the sample has been left in a normal temperature and normal humidity more than 1 hour.															

Test conditions :

The sample shall be reflow soldered onto the printed circuit board in every test.

文件编号 File Number	SRD-WI-3657	版本号 Version Number	A	页码 page	8/8
---------------------	-------------	-----------------------	---	------------	-----

8、注意事项 Note

①本承认书保证我司产品作为一个单体时的质量情况。当我司产品被安装到贵公司产品上时，请保证贵司的产品已根据贵司的规范进行了有效评估和确认。

This product specification guarantees the quality of our product as a single unit. Please make sure that your product is evaluated and confirmed against your specifications when our product is mounted to your product.

②如果贵司对我司产品的使用已超过了本承认书所界定的产品功能，那么对于由此引发的失效，我司将不予保证。

We cannot warrant against failure caused by any use of our product that deviates from the intended use as described in this product specification.

③为了保持终端电极的焊接性，并使包装材料保持良好状态，必须控制储存区的温度和湿度。

To maintain the solderability of terminal electrodes and to keep the packing material in good condition, temperature and humidity in the storage area should be controlled.

※建议的条件：-10 ~ +40℃，30~70%RH。

Recommended conditions: -10 ~ +40℃，30~70%RH.

※储存超过六个月的，应在实际使用前进行焊接检验。

In case of storage over 6 months, solderability shall be checked before actual usage.

※即使在理想的储存条件下，产品的可焊性也随着时间的推移而降低。因此，产品应从交货时算起，建议8个月之内使用完。

Even under ideal storage conditions, the weldability of the product decreases over time.

therefore, the product should be From the time of delivery, it is recommended that it be used within 8 months.

④本承认书在客户收到30天之内，必须签章返回，逾期视为默认。

The Specification Approval should be sent back to the supplier with customer's chop on it within 30 days after receiving it, or we will take it as approved by customer's automatically.

⑤如有特殊规格要求，请事前联络我司技术部人员。

In case of special specifications please contact our technical department prior staff.

X-ON Electronics

Largest Supplier of Electrical and Electronic Components

Click to view similar products for [Fixed Inductors](#) category:

Click to view products by [SOREDE](#) manufacturer:

Other Similar products are found below :

[CR32NP-100KC](#) [CR54NP-470LC](#) [70F224AI](#) [MGDQ4-00004-P](#) [MHQ1005P10NJ](#) [MHQ1005P1N0S](#) [MHQ1005P2N4S](#) [MHQ1005P3N6S](#)
[MHQ1005P5N1S](#) [MHQ1005P8N2J](#) [PE-53601NL](#) [PE-53602NL](#) [PG0936.113NLT](#) [9220-20](#) [9310-16](#) [PM06-2N7](#) [PM06-39NJ](#) [A01TK](#)
[1206CS-471XJ](#) [HC2-R47-R](#) [HC8-1R2-R](#) [HCF1305-3R3-R](#) [1206CS-151XG](#) [RCH664NP-140L](#) [RCH664NP-4R7M](#) [RCP1317NP-391L](#)
[RCR110DNP-331L](#) [DH2280-4R7M](#) [DS1608C-106](#) [B10TJ](#) [B82498B3101J000](#) [ELJ-RE27NJF2](#) [1812CS-153XJ](#) [1812CS-183XJ](#) [1812CS-](#)
[223XJ](#) [1812LS-104XJ](#) [1812LS-105XJ](#) [1812LS-124XJ](#) [1812LS-154XJ](#) [1812LS-223XJ](#) [1812LS-224XJ](#) [1812LS-563XJ](#) [1812LS-683XJ](#)
[1812LS-824XJ](#) [NIN-FB101JTR110F](#) [NIN-FB471JTR62F](#) [NIN-FC1R5JTR220F](#) [NIN-HCR15JTRF](#) [NIN-HCR33JTRF](#) [NIN-HDR22JTRF](#)