

# 瓷介电容器 Ceramic Capacitors

## 特性 Feature

- 容量范围 Wide capacitance range from 100pF to 10000pF
- 工作温度 Operating Temperature: -40℃~125℃
- 存储温度 Storage Temperature: -10℃~40℃

## 应用 Applications

瓷介电容器适用于电子设备的电源电路噪声抑制电路中，也可用于天线耦合跨接和旁路电路中。  
These products Can be used in noise suppression of power supply circuit for general electronic equipment, and might be used as antenna coupling, crossing and bypass circuit.

## 使用标准Applicable Standard

通过认证 APPROVAL	认证组织 ORGANIZATION	标准. SAFTY STANDARDS	证书 CERTIFICATE NO.
	UL CUL	UL60384-14	E154899
	CSA	CAN/CSA-E60384-14	2405436 2405437
	(VDE+ENEC)VD E	IEC 60384 -14	40036393 40036246
	SEMKO	EN60384-14	1914801
	KTC	K60384 - 14	HU03004-16006A HU03004-16007A HU03004-16008A
	NEMKO	EN60384-14	P19223823
	DEMKO	EN60384-14	D-03468-M1
	FIMKO	IEC 60384 -14	FI 40341
	SEV	IEC 60384 -14	19.0474 19.0475
	CQC	IEC 60384 -14	CQC15001124387 CQC15001124387 CQC15001127382

# 产品型号 Part Number

DCF 331 K 30 Y5P G 6 B L 0 □ □

## 型号 Type:

DCF: 交流圆片瓷介电容器  
DCG: 超高压瓷片电容器  
DCH: 高压圆片瓷介电容器

## 电容量 (Capacitance):

470: 47pF  
471: 470pF  
472: 2200pF  
103: 10000pF

## 电容量允许偏差

### Capacitance Tolerance:

M=20%      Z=+80%-20%  
K=±10%    J=±5%

## 尺寸代码 Size:

见规格详情  
See the specification

## 温度特性

### temperature characteristic:

Y5P, Y5U, Y5V

## 额定电压 Rated voltage:

N=1KVDC    P=2KVDC    R=3KVDC  
G=X1 400VAC    Y1 250VAC    Q=X1 400VAC/Y2 250VAC

## 电极材料:

**Electrode Material**  
Copper or Silver electrode

## 内部管理代码

**Interior managing**

## 位引线间距 Lead spacing:

5=5.0mm    7=7.5mm    0=10mm

## 引线式样 Lead style:

L、P  
见引线形状 see the lead style  
Figure1-2 and figure 1-5

## 位引线长度/包装方法/

### Lead length/package:

B=26.0±1.0mm, L=2.3±0.3mm  
D=4.5±0.5mm, J=3.2±0.3mm,  
W=3.4±0.3mm, K=2.8±0.5mm,  
F=12.7mm 编带/扇折, V=15.0mm 编带/扇折

## 引线直径 Lead diameter:

CP 线:  
6=0.55±0.05mm    8=0.78±0.05mm

## 脚型 Lead style

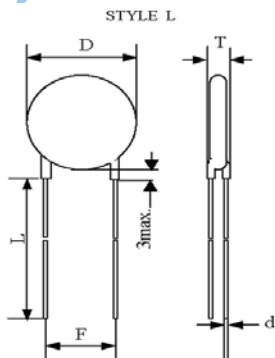

Figure 1-2

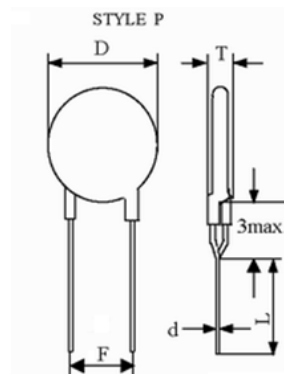

Figure 1-5

# 规格Specification

SHM 产品代码 SHM Part No.	额定电压 Rated voltage (VAC)	标称容量 Nominal capacitance (pF)	电容量允许 偏差范围 Tolerance (%)	温度特性 Temperature Characteristic	产品尺寸 (mm)				
					直径 Dmax. (mm)	厚度 Tmax. (mm)	引线间距 F (mm)	引线直径 d (mm)	散件/ 编带
DCF101K24Y5PG5LK4CV	Y1 250~	100	±10%	Y5P (B)	6.0	6.0	8.0	0.48±0.05	散件
DCF101K24Y5PG5LKACK	Y1 250~	100	±10%	Y5P (B)	6.0	6.0	10.0	0.48±0.05	散件
DCF101K24Y5PG5LLACK	Y1 250~	100	±10%	Y5P (B)	6.0	6.0	10.0	0.48±0.05	散件
DCF101K24Y5PG5LLACV	Y1 250~	100	±10%	Y5P (B)	6.0	6.0	10.0	0.48±0.05	散件
DCF101K24Y5PG5MLACK	Y1 250~	100	±10%	Y5P (B)	6.0	6.0	10.0	0.48±0.05	散件
DCF101K24Y5PG62L9CK	Y1 250~	100	±10%	Y5P (B)	6.0	6.0	9	0.55±0.05	散件
DCF101K24Y5PG6VH0EG	Y1 250~	100	±10%	Y5P (B)	6.0	6.0	10.0	0.55±0.05	编带
DCF101K26Y5PG62L0A0	Y1 250~	100	±10%	Y5P (B)	6.8	6.0	10.0	0.55±0.05	散件
DCF101K26Y5PG63H0BL	Y1 250~	100	±10%	Y5P (B)	6.8	6.0	10.0	0.55±0.05	散件
DCF101K26Y5PG9VPOCW	Y1 250~	100	±10%	Y5P (B)	6.8	6.0	10.0	0.58±0.05	编带
DCF102M26Y5UG62L0A0	Y1 250~	1000	±20%	Y5U (E)	6.8	6.0	10.0	0.55±0.05	散件
DCF102M26Y5UG6CL0A0	Y1 250~	1000	±20%	Y5U (E)	6.8	6.0	10.0	0.55±0.05	散件
DCF102M26Y5UG6CL0L0	Y1 250~	1000	±20%	Y5U (E)	6.8	6.0	10.0	0.55±0.05	散件
DCF102M26Y5UG6JL0A2	Y1 250~	1000	±20%	Y5U (E)	6.8	6.0	10.0	0.55±0.05	散件
DCF102M26Y5UG6WL0A0	Y1 250~	1000	±20%	Y5U (E)	6.8	6.0	10.0	0.55±0.05	散件
DCF102M26Y5UG6WL0A2	Y1 250~	1000	±20%	Y5U (E)	6.8	6.0	10.0	0.55±0.05	散件
DCF102M26Y5UG9VPOCW	Y1 250~	1000	±20%	Y5U (E)	6.8	6.0	10.0	0.58±0.05	编带
DCF102M26Y5UQ66L7A6	Y2 250~	1000	±20%	Y5U (E)	6.8	5.0	7.5	0.55±0.05	散件
DCF102M26Y5UQ6WL7A0	Y2 250~	1000	±20%	Y5U (E)	6.8	5.0	7.5	0.55±0.05	散件
DCF102M30Y5UQ6VHDA0	Y2 250~	1000	±20%	Y5U (E)	7.8	5.0	7.5	0.55±0.05	编带
DCF102M30Y5UQEYK7A0	Y2 250~	1000	±20%	Y5U (E)	7.8	5.0	7.5	0.58±0.05	编带
DCF102M34Y5UG6JK0AB	Y1 250~	1000	±20%	Y5U (E)	9.0	6.0	10.0	0.55±0.05	散件
DCF102M34Y5UG6VH0DA	Y1 250~	1000	±20%	Y5U (E)	9.0	6.0	10.0	0.55±0.05	编带
DCF102M34Y5UG6WK0A0	Y1 250~	1000	±20%	Y5U (E)	9.0	6.0	10.0	0.55±0.05	散件
DCF102M34Y5UG6WW0A0	Y1 250~	1000	±20%	Y5U (E)	9.0	6.0	10.0	0.55±0.05	散件
DCF103M56Y5VQ66L7A6	Y2 250~	10000	±20%	Y5V (F)	14.7	5.0	7.5	0.55±0.05	编带
DCF103M56Y5VQEYK7A0	Y2 250~	10000	±20%	Y5V (F)	14.7	5.0	7.5	0.58±0.05	编带
DCF103M69Y5VG8ULAL0	Y1 250~	10000	±20%	Y5V (F)	18.0	6.0	10.0	0.78±0.05	编带
DCF151K24Y5PG6VHAET	Y1 250~	150	±10%	Y5P (B)	6.0	6.0	10.0	0.55±0.05	编带
DCF152M30Y5UG66L0A2	Y1 250~	1500	±20%	Y5U (E)	7.8	6.0	10.0	0.55±0.05	散件
DCF152M30Y5VG6WL0A0	Y1 250~	1500	±20%	Y5V (F)	7.8	6.0	10.0	0.55±0.05	散件
DCF152M36Y5UG63P1A2	Y1 250~	1500	±20%	Y5U (E)	9.8	6.0	10.5	0.55±0.05	散件

DCF152M36Y5UG6JL0A0	Y1 250~	1500	±20%	Y5U(E)	9.8	6.0	10.0	0.55±0.05	散件
DCF152M36Y5UG6WP0A0	Y1 250~	1500	±20%	Y5U(E)	9.8	6.0	10.0	0.55±0.05	散件
DCF221K22Y5PG6KP9F2	Y1 250~	220	±10%	Y5P(B)	5.5	6.0	9	0.55±0.05	散件
DCF221K22Y5PG6VL9DD	Y1 250~	220	±10%	Y5P(B)	5.5	6.0	9	0.55±0.05	编带
DCF221K22Y5PQ62LDDD	Y2 250~	220	±10%	Y5P(B)	5.5	5.0	7.5	0.55±0.05	散件
DCF221K22Y5PQ6KLDDD	Y2 250~	220	±10%	Y5P(B)	5.5	5.0	7.5	0.55±0.05	散件
DCF221K22Y5PQ6ML7C9	Y2 250~	220	±10%	Y5P(B)	5.5	5.0	7.5	0.55±0.05	散件
DCF221K22Y5PQ6VHDET	Y2 250~	220	±10%	Y5P(B)	5.5	5.0	7.5	0.55±0.05	编带
DCF221K24Y5PG52LACK	Y1 250~	220	±10%	Y5P(B)	6.0	6.0	10.0	0.48±0.05	散件
DCF221K24Y5PG62K9G7	Y1 250~	220	±10%	Y5P(B)	6.0	6.0	9	0.55±0.05	散件
DCF221K24Y5PG62P9F2	Y1 250~	220	±10%	Y5P(B)	6.0	6.0	9	0.55±0.05	散件
DCF221K24Y5PG6KH9CK	Y1 250~	220	±10%	Y5P(B)	6.0	6.0	9	0.55±0.05	散件
DCF221K24Y5PG6KHACK	Y1 250~	220	±10%	Y5P(B)	6.0	6.0	10.0	0.55±0.05	散件
DCF221K24Y5PG6VHODA	Y1 250~	220	±10%	Y5P(B)	6.0	6.0	10.0	0.55±0.05	编带
DCF221K24Y5PG6VHOFD	Y1 250~	220	±10%	Y5P(B)	6.0	6.0	10.0	0.55±0.05	编带
DCF221K26Y5PG62L0A0	Y1 250~	220	±10%	Y5P(B)	6.8	6.0	10.0	0.55±0.05	散件
DCF221K26Y5PG6JK0A0	Y1 250~	220	±10%	Y5P(B)	6.8	6.0	10.0	0.55±0.05	散件
DCF221K26Y5PG6JL0A2	Y1 250~	220	±10%	Y5P(B)	6.8	6.0	10.0	0.55±0.05	散件
DCF221K26Y5PG6JP0A0	Y1 250~	220	±10%	Y5P(B)	6.8	6.0	10.0	0.55±0.05	散件
DCF221K26Y5PG6VHAF8	Y1 250~	220	±10%	Y5P(B)	6.8	6.0	10.0	0.55±0.05	编带
DCF221K26Y5PG6VKAA0	Y1 250~	220	±10%	Y5P(B)	6.8	6.0	10.0	0.55±0.05	编带
DCF221K26Y5PG6WK0A0	Y1 250~	220	±10%	Y5P(B)	6.8	6.0	10.0	0.55±0.05	散件
DCF221K26Y5PG6WL0A0	Y1 250~	220	±10%	Y5P(B)	6.8	6.0	10.0	0.55±0.05	散件
DCF221K26Y5PG6WL1A2	Y1 250~	220	±10%	Y5P(B)	6.8	6.0	10.5	0.55±0.05	散件
DCF221K26Y5PG6WP0A0	Y1 250~	220	±10%	Y5P(B)	6.8	6.0	10.0	0.55±0.05	散件
DCF221K26Y5PG73L0A0	Y1 250~	220	±10%	Y5P(B)	6.8	6.0	10.0	0.65±0.05	散件
DCF221K26Y5PG9VP0L0	Y1 250~	220	±10%	Y5P(B)	6.8	6.0	10.0	0.58±0.05	编带
DCF221K26Y5PQ62L7BL	Y2 250~	220	±10%	Y5P(B)	6.8	5.0	7.5	0.55±0.05	散件
DCF221K30Y5PG6VH0BT	Y1 250~	220	±10%	Y5P(B)	7.8	6.0	10.0	0.55±0.05	编带
DCF222M30Y5UQ6WL7A0	Y2 250~	2200	±20%	Y5U(E)	7.8	5.0	7.5	0.55±0.05	散件
DCF222M30Y5VQ6VL7BU	Y2 250~	2200	±20%	Y5V(F)	7.8	5.0	7.5	0.55±0.05	编带
DCF222M34Y5UG65L0A0	Y1 250~	2200	±20%	Y5U(E)	9.0	6.0	10.0	0.55±0.05	散件
DCF222M34Y5UG6BL0L0	Y1 250~	2200	±20%	Y5U(E)	9.0	6.0	10.0	0.55±0.05	散件
DCF222M34Y5UG6JK0A0	Y1 250~	2200	±20%	Y5U(E)	9.0	6.0	10.0	0.55±0.05	散件
DCF222M34Y5UG6JL0A0	Y1 250~	2200	±20%	Y5U(E)	9.0	6.0	10.0	0.55±0.05	散件
DCF222M34Y5UG6VL7BU	Y1 250~	2200	±20%	Y5U(E)	9.0	6.0	7.5	0.55±0.05	编带
DCF222M34Y5UG6WK0A0	Y1 250~	2200	±20%	Y5U(E)	9.0	6.0	10.0	0.55±0.05	散件

DCF222M34Y5UG6WL0A2	Y1 250~	2200	±20%	Y5U(E)	9.0	6.0	10.0	0.55±0.05	散件
DCF222M34Y5UG6WL0L0	Y1 250~	2200	±20%	Y5U(E)	9.0	6.0	10.0	0.55±0.05	散件
DCF222M34Y5UGEVK7A0	Y1 250~	2200	±20%	Y5U(E)	9.0	6.0	7.5	0.58±0.05	编带
DCF222M34Y5UQ6VL7BU	Y2 250~	2200	±20%	Y5U(E)	9.0	5.0	7.5	0.55±0.05	编带
DCF222M34Y5UQ6WK7A0	Y2 250~	2200	±20%	Y5U(E)	9.0	5.0	7.5	0.55±0.05	散件
DCF222M34Y5UQ6WL7A0	Y2 250~	2200	±20%	Y5U(E)	9.0	5.0	7.5	0.55±0.05	散件
DCF222M34Y5UQ6WP7A0	Y2 250~	2200	±20%	Y5U(E)	9.0	5.0	7.5	0.55±0.05	散件
DCF222M34Y5VG6WL0A0	Y1 250~	2200	±20%	Y5V(F)	9.0	6.0	10.0	0.55±0.05	散件
DCF222M39Y5UGEUP0A0	Y1 250~	2200	±20%	Y5U(E)	10.5	6.0	10.0	0.58±0.05	编带
DCF331K26Y5PG6JL0A0	Y1 250~	330	±10%	Y5P(B)	6.8	6.0	10.0	0.55±0.05	散件
DCF331K26Y5PG6VHAEC	Y1 250~	330	±10%	Y5P(B)	6.8	6.0	10.0	0.55±0.05	编带
DCF331K26Y5PQ6JHDCH	Y2 250~	330	±10%	Y5P(B)	6.8	5.0	7.5	0.55±0.05	散件
DCF331K30Y5PG6JHAFW	Y1 250~	330	±10%	Y5P(B)	7.8	6.0	10.0	0.55±0.05	散件
DCF331K30Y5PG6KHAFW	Y1 250~	330	±10%	Y5P(B)	7.8	6.0	10.0	0.55±0.05	散件
DCF332M39Y5UG6JK0L0	Y1 250~	3300	±20%	Y5U(E)	10.5	6.0	10.0	0.55±0.05	散件
DCF332M39Y5VG6WL0A0	Y1 250~	3300	±20%	Y5V(F)	10.5	6.0	10.0	0.55±0.05	散件
DCF470K26Y5PG6LHADP	Y1 250~	47	±10%	Y5P(B)	6.8	6.0	10.0	0.55±0.05	散件
DCF470K26Y5PG6MH0AD	Y1 250~	47	±10%	Y5P(B)	6.8	6.0	10.0	0.55±0.05	散件
DCF471K26Y5PG6JL0A2	Y1 250~	470	±10%	Y5P(B)	6.8	6.0	10.0	0.55±0.05	散件
DCF471K26Y5PG6JP0A0	Y1 250~	470	±10%	Y5P(B)	6.8	6.0	10.0	0.55±0.05	散件
DCF471K26Y5PG6WH0A1	Y1 250~	470	±10%	Y5P(B)	6.8	6.0	10.0	0.55±0.05	散件
DCF471K26Y5PG9VP0CW	Y1 250~	470	±10%	Y5P(B)	6.8	6.0	10.0	0.58±0.05	编带
DCF471K30Y5PG5LKACH	Y1 250~	470	±10%	Y5P(B)	7.8	6.0	10.0	0.48±0.05	散件
DCF471K30Y5PG62L0A8	Y1 250~	470	±10%	Y5P(B)	7.8	6.0	10.0	0.55±0.05	散件
DCF471K30Y5PQ6DL7A1	Y2 250~	470	±10%	Y5P(B)	7.8	5.0	7.5	0.55±0.05	散件
DCF471K30Y5PQ6WP7A0	Y2 250~	470	±10%	Y5P(B)	7.8	5.0	7.5	0.55±0.05	散件
DCF471K34Y5PG6JK0AB	Y1 250~	470	±10%	Y5P(B)	9.0	6.0	10.0	0.55±0.05	散件
DCF471K34Y5PG6JL0A3	Y1 250~	470	±10%	Y5P(B)	9.0	6.0	10.0	0.55±0.05	散件
DCF471K34Y5PG6VH0DA	Y1 250~	470	±10%	Y5P(B)	9.0	6.0	10.0	0.55±0.05	编带
DCF471M26Y5UG6VH0B8	Y1 250~	470	±20%	Y5U(E)	6.8	6.0	10.0	0.55±0.05	编带
DCF471M26Y5UG6WK0A0	Y1 250~	470	±20%	Y5U(E)	6.8	6.0	10.0	0.55±0.05	散件
DCF471M26Y5UG9VP0L0	Y1 250~	470	±20%	Y5U(E)	6.8	6.0	10.0	0.58±0.05	编带
DCF472M39Y5UQ6VL7A0	Y2 250~	4700	±20%	Y5U(E)	10.5	5.0	7.5	0.55±0.05	编带
DCF472M39Y5UQEVK7BB	Y2 250~	4700	±20%	Y5U(E)	10.5	5.0	7.5	0.58±0.05	编带
DCF472M39Y5UQEVL7A6	Y2 250~	4700	±20%	Y5U(E)	10.5	5.0	7.5	0.58±0.05	编带
DCF472M39Y5VQ6WL7A0	Y2 250~	4700	±20%	Y5V(F)	10.5	5.0	7.5	0.55±0.05	散件
DCF472M46Y5VG6WK0A0	Y1 250~	4700	±20%	Y5V(F)	12.3	6.0	10.0	0.55±0.05	散件

DCF472M46Y5VGCVL0L0	Y1 250~	4700	±20%	Y5V(F)	12. <sub>3</sub>	6.0	10.0	0.65±0.05	编带
DCF680K24Y5PG63HACK	Y1 250~	68	±10%	Y5P(B)	6.0	6.0	10.0	0.55±0.05	散件
DCF681K36Y5PG6VH0CW	Y1 250~	680	±10%	Y5P(B)	9.8	6.0	10.0	0.55±0.05	编带

## 电性能指标 Electrical Performance

序号 No.	项目名称 Item		技术要求 Specification	
1	容量和误差 C		@25°C, 1 kHz and 1 Vrms	参照规格表 See the specification
2	损耗系数 DF		@25°C, 1 kHz and 1 Vrms	2.5% max.
3	绝缘电阻 IR		@500 VDC, 60S	10000MΩ min
4	耐电压 Rate Voltage	X1/Y2	2600Vrms	无击穿或飞弧。 No visible damage
		X1/Y1	2500Vrms	
5	温度特性 temperature characteristic	Y5P	±10%	
		Y5U	+22% to -56%	
		Y5V	+22% to -82%	

## 标志 Marking

例如 e.g

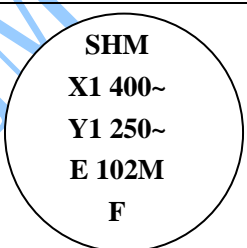
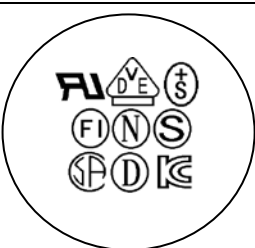
Y1 电容器	
正面	反面
	

Y2 电容器	
正面	反面

SHM  
X1 400~  
Y2 250~  
E 102M  
F



SHM®

SHM®

SHM®

## TAPING STYLE V

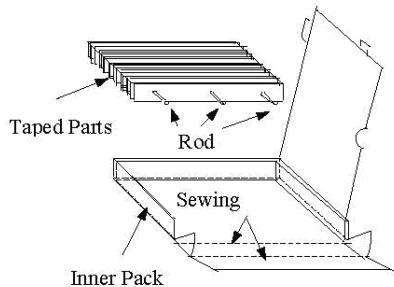

Symbol	Dimension(mm)
<b>P0</b>	<b>15.0±0.2</b>
<b>P</b>	<b>15.0±1.0</b>
<b>F</b>	<b>10.0±0.5</b>
<b>P1</b>	
<b>P2</b>	
<b>H0</b>	<b>16.0±0.5*1</b>
<b>H</b>	<b>20.0±0.5*2</b>
<b>W</b>	<b>18.0±0.5</b>
<b>W0</b>	<b>8.0min.</b>
<b>W1</b>	<b>9.0±0.3</b>
<b>W2</b>	<b>3.0max.</b>
<b>t</b>	<b>0.7±0.2</b>
<b>D</b>	To comply with individual sheet
<b>D0</b>	<b>4±0.2</b>
<b>d</b>	To comply with individual sheet
<b>l</b>	<b>2.0max.</b>
<b>T</b>	To comply with individual sheet
<b>ΔS</b>	<b>1.0 max.</b>
<b>Δh</b>	<b>1.0 max.</b>

1. \*1 打弯脚型以H0为准。

For kink lead only.

2. \*2 直脚产品以H为准。

For straight lead only.

**Figure 3**



## TAPING STYLE U

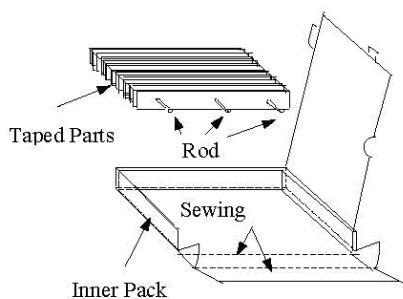
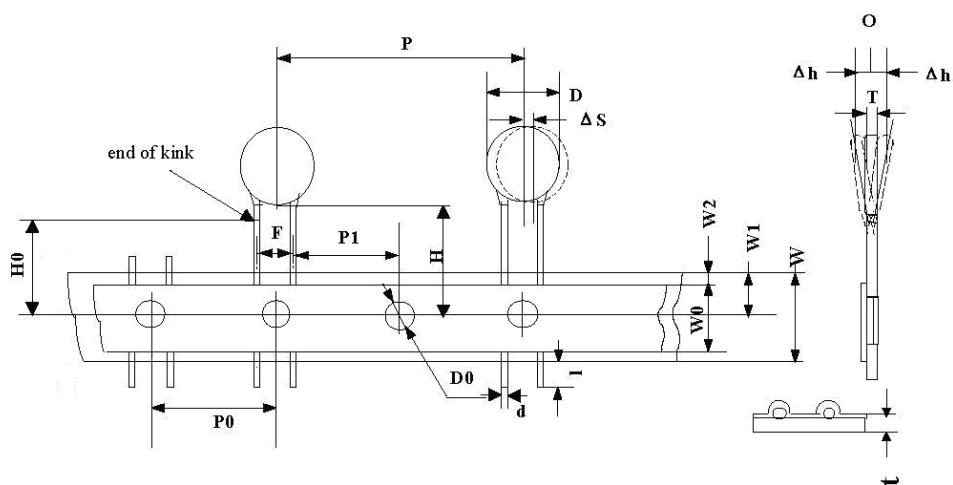

Symbol	Dimension(mm)
<b>P0</b>	<b>12.7±0.2</b>
<b>P</b>	<b>25.4±1.0</b>
<b>F</b>	<b>10.0±0.5</b>
<b>P1</b>	<b>7.7±0.4</b>
<b>P2</b>	
<b>H0</b>	<b>16.0±0.5*1</b>
<b>H</b>	<b>20.0±0.5*2</b>
<b>W</b>	<b>18.0±0.5</b>
<b>W0</b>	<b>8.0min.</b>
<b>W1</b>	<b>9.0±0.3</b>
<b>W2</b>	<b>3.0max.</b>
<b>t</b>	<b>0.7±0.2</b>
<b>D</b>	To comply with individual sheet
<b>D0</b>	<b>4±0.2</b>
<b>d</b>	To comply with individual sheet
<b>l</b>	<b>2.0max.</b>
<b>T</b>	To comply with individual sheet
<b>Δ S</b>	<b>1.0 max.</b>
<b>Δ h</b>	<b>1.0 max.</b>

1. \*1 打弯脚型以H0为准。

For kink lead only.

2. \*2 直脚产品以H为准。

For straight lead only.

**Figure 6**

## X-ON Electronics

Largest Supplier of Electrical and Electronic Components

*Click to view similar products for [Safety Capacitors](#) category:*

*Click to view products by [South HongMing](#) manufacturer:*

Other Similar products are found below :

[B32022B3223K026](#) [B32912A3104K026](#) [46KI3470DQM1K](#) [B32913A3154K](#) [B81123C1102M003](#) [MKPY2-.02230020P15](#)  
[46KN333000M1M](#) [46KN422000P0M](#) [DE1E3KX222MJ4BN01F](#) [46KR422000M1K](#) [HUB2200-S](#) [46KF268000M1M](#) [46KI3150NDM2M](#)  
[PHE840MD6220MD13R30](#) [PHE840MY6470MD14R06](#) [PHE845VD5470MR06](#) [R463N4100ZAM1K](#) [MKPX2R-1/400/10P27](#)  
[YP500101K040B20C2P](#) [YU0AH222M090DAMD0B](#) [LS1808N102K302NX080TM](#) [CY1471KE1IEB46X2A2](#) [CY1222ME5IEE48O2A2](#)  
[MPX474K31DTEV158G0](#) [CY1471ME19EE45W2A2](#) [MPX104K31D2KN158HF](#) [MPX224K31D2KN158G0](#) [PX104K2W1502](#)  
[YU1AH222M090DASD0H](#) [C47S1472K60C000](#) [MP2224K32C5J6LC](#) [H102M050FQ55250L750A](#) [MP2474K32D6R8LC](#)  
[MP2224K32C3J6LC](#) [MP2104K32C3J6LC](#) [PX334K2C1006](#) [YU0AC222M080L20C7B](#) [MP2473K27B2X6LC](#) [MP2224K32D4J8LC](#)  
[MP2684K32D6T8LC](#) [ST3Y1Y5U332M500VAC](#) [ST3Y1Y5V472M500VAC](#) [MP2474K32D4X8LC](#) [MP2474K32D4J8LC](#)  
[YU0AH332M110L4EB0B](#) [CY1681ME1IEE45S2A2](#) [Y1220J-E1I-B4-AC400V](#) [Y1120K-E1I-B4-AC400V](#) [MP2154K32D2R8LC](#)  
[ST1Y1Y5V222M500VAC](#)