

瓷介电容器 Ceramic Capacitors





特性 Feature

- 容量范围 Wide capacitance range from 100pF to 10000pF
- 工作温度 Operating Temperature: -40℃~125℃
- 存储温度 Storage Temperature: -10℃~40℃

应用 Applications

瓷介电容器适用于电子设备的电源电路噪声抑制电路中，也可用于天线耦合跨接和旁路电路中。
These products Can be used in noise suppression of power supply circuit for general electronic equipment, and might be used as antenna coupling, crossing and bypass circuit.

使用标准Applicable Standard

通过认证 APPROVAL	认证组织 ORGANIZATION	标准. SAFTY STANDARDS	证书 CERTIFICATE NO.
	UL CUL	UL60384-14	E154899
	CSA	CAN/CSA-E60384-14	2405436 2405437
	(VDE+ENEC)VD E	IEC 60384 -14	40036393 40036246
	SEMKO	EN60384-14	1914801
	KTC	K60384 - 14	HU03004-16006A HU03004-16007A HU03004-16008A
	NEMKO	EN60384-14	P19223823
	DEMKO	EN60384-14	D-03468-M1
	FIMKO	IEC 60384 -14	FI 40341
	SEV	IEC 60384 -14	19.0474 19.0475
	CQC	IEC 60384 -14	CQC15001124387 CQC15001124387 CQC15001127382

产品型号 Part Number

DCF 331 K 30 Y5P G 6 B L 0 □ □

型号 Type:

DCF: 交流圆片瓷介电容器
DCG: 超高压瓷片电容器
DCH: 高压圆片瓷介电容器

电容量 (Capacitance):

470: 47pF
471: 470pF
472: 2200pF
103: 10000pF

电容量允许偏差

Capacitance Tolerance:

M=20% Z=+80%-20%
K=±10% J=±5%

尺寸代码 Size:

见规格详情
See the specification

温度特性

temperature characteristic:

Y5P, Y5U, Y5V

额定电压 Rated voltage:

N=1KVDC P=2KVDC R=3KVDC
G=X1 400VAC Y1 250VAC Q=X1 400VAC/Y2 250VAC

电极材料:

Electrode Material
Copper or Silver electrode

内部管理代码

Interior managing

位引线间距 Lead spacing:

5=5.0mm 7=7.5mm 0=10mm

引线式样 Lead style:

L、P
见引线形状 see the lead style
Figure1-2 and figure 1-5

位引线长度/包装方法/

Lead length/package:

B=26.0±1.0mm, L=2.3±0.3mm
D=4.5±0.5mm, J=3.2±0.3mm,
W=3.4±0.3mm, K=2.8±0.5mm,
F=12.7mm 编带/扇折, V=15.0mm 编带/扇折

引线直径 Lead diameter:

CP 线:
6=0.55±0.05mm 8=0.78±0.05mm

脚型 Lead style

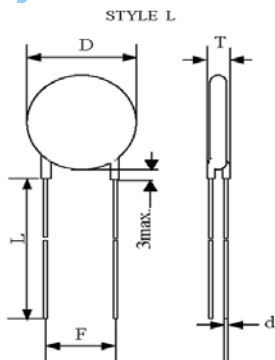

Figure 1-2

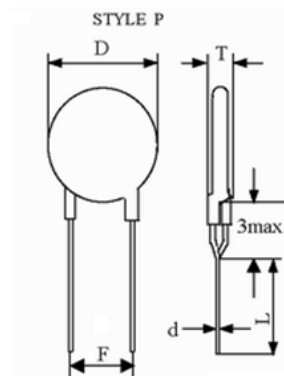

Figure 1-5

规格Specification

SHM 产品代码 SHM Part No.	额定电压 Rated voltage (VAC)	标称容量 Nominal capacitance (pF)	电容量允许偏差范围 Tolerance (%)	温度特性 Temperature Characteristic	产品尺寸(mm)				
					直径 Dmax. (mm)	厚度 Tmax. (mm)	引线间距 F(mm)	引线直径 d (mm)	散件/ 编带
DCF101K22Y5PG53L0A0	Y1 250~	100	±10%	Y5P(B)	5.5	6.0	10.0	0.48±0.05	散件
DCF101K26Y5PG63L0A0	Y1 250~	100	±10%	Y5P(B)	6.8	6.0	10.0	0.55±0.05	散件
DCF101K26Y5PG6JL0A0	Y1 250~	100	±10%	Y5P(B)	6.8	6.0	10.0	0.55±0.05	散件
DCF101K26Y5PG6JP0A0	Y1 250~	100	±10%	Y5P(B)	6.8	6.0	10.0	0.55±0.05	散件
DCF101K26Y5PG6UK0A0	Y1 250~	100	±10%	Y5P(B)	6.8	6.0	10.0	0.55±0.05	编带
DCF101K26Y5PG6VL0A0	Y1 250~	100	±10%	Y5P(B)	6.8	6.0	10.0	0.55±0.05	编带
DCF101K26Y5PG6WL0A0	Y1 250~	100	±10%	Y5P(B)	6.8	6.0	10.0	0.55±0.05	散件
DCF101K26Y5PG6WP0L0	Y1 250~	100	±10%	Y5P(B)	6.8	6.0	10.0	0.55±0.05	散件
DCF101M26Y5UG6WP0A0	Y1 250~	100	±20%	Y5U(E)	6.8	6.0	10.0	0.55±0.05	散件
DCF102K36Y5PQ6VL7A0	Y2 250~	1000	±10%	Y5P(B)	9.8	5.0	7.5	0.55±0.05	编带
DCF102K36Y5PQ6WL7A0	Y2 250~	1000	±10%	Y5P(B)	9.8	5.0	7.5	0.55±0.05	散件
DCF102K43Y5PG6BL0A0	Y1 250~	1000	±10%	Y5P(B)	11.5	6.0	10.0	0.55±0.05	散件
DCF102K43Y5PG6VP0A0	Y1 250~	1000	±10%	Y5P(B)	11.5	6.0	10.0	0.55±0.05	编带
DCF102M26Y5UG60L0A0	Y1 250~	1000	±20%	Y5U(E)	6.8	6.0	10.0	0.55±0.05	散件
DCF102M26Y5UG65L0A0	Y1 250~	1000	±20%	Y5U(E)	6.8	6.0	10.0	0.55±0.05	散件
DCF102M26Y5UG68L0A0	Y1 250~	1000	±20%	Y5U(E)	6.8	6.0	10.0	0.55±0.05	散件
DCF102M26Y5UG6AL0A0	Y1 250~	1000	±20%	Y5U(E)	6.8	6.0	10.0	0.55±0.05	散件
DCF102M26Y5UG6BL0A0	Y1 250~	1000	±20%	Y5U(E)	6.8	6.0	10.0	0.55±0.05	散件
DCF102M26Y5UG6JK0A0	Y1 250~	1000	±20%	Y5U(E)	6.8	6.0	10.0	0.55±0.05	散件
DCF102M26Y5UG6JL0A0	Y1 250~	1000	±20%	Y5U(E)	6.8	6.0	10.0	0.55±0.05	散件
DCF102M26Y5UG6JP0A0	Y1 250~	1000	±20%	Y5U(E)	6.8	6.0	10.0	0.55±0.05	散件
DCF102M26Y5UG6UL0A0	Y1 250~	1000	±20%	Y5U(E)	6.8	6.0	10.0	0.55±0.05	编带
DCF102M26Y5UG6VL0A0	Y1 250~	1000	±20%	Y5U(E)	6.8	6.0	10.0	0.55±0.05	编带
DCF102M26Y5UQ68L7A0	Y2 250~	1000	±20%	Y5U(E)	6.8	5.0	7.5	0.55±0.05	散件
DCF102M26Y5VG6BL0A0	Y1 250~	1000	±20%	Y5V(F)	6.8	6.0	10.0	0.55±0.05	散件
DCF102M26Y5VG6UP0A0	Y1 250~	1000	±20%	Y5V(F)	6.8	6.0	10.0	0.55±0.05	编带
DCF102M26Y5VG6WL0A0	Y1 250~	1000	±20%	Y5V(F)	6.8	6.0	10.0	0.55±0.05	散件
DCF102M26Y5VQ6VL7A0	Y2 250~	1000	±20%	Y5V(F)	6.8	5.0	7.5	0.55±0.05	编带
DCF102M30Y5UQ6JK7A0	Y2 250~	1000	±20%	Y5U(E)	7.8	5.0	7.5	0.55±0.05	散件
DCF102M30Y5UQ6VP7A0	Y2 250~	1000	±20%	Y5U(E)	7.8	5.0	7.5	0.55±0.05	编带
DCF102M30Y5UQ6WP7A0	Y2 250~	1000	±20%	Y5U(E)	7.8	5.0	7.5	0.55±0.05	散件
DCF102M34Y5UG6JL0A0	Y1 250~	1000	±20%	Y5U(E)	9.0	6.0	10.0	0.55±0.05	散件

DCF102M34Y5UG6JP0A0	Y1 250~	1000	±20%	Y5U(E)	9.0	6.0	10.0	0.55±0.05	散件
DCF102M34Y5UG6VK0A0	Y1 250~	1000	±20%	Y5U(E)	9.0	6.0	10.0	0.55±0.05	编带
DCF102M34Y5UG6VL0A0	Y1 250~	1000	±20%	Y5U(E)	9.0	6.0	10.0	0.55±0.05	编带
DCF103M56Y5UQ66L7A0	Y2 250~	10000	±20%	Y5U(E)	14.7	5.0	7.5	0.55±0.05	散件
DCF103M56Y5UQ6JK7A0	Y2 250~	10000	±20%	Y5U(E)	14.7	5.0	7.5	0.55±0.05	散件
DCF103M56Y5VQ68L7A0	Y2 250~	10000	±20%	Y5V(F)	14.7	5.0	7.5	0.55±0.05	散件
DCF103M56Y5VQ6JK0A0	Y2 250~	10000	±20%	Y5V(F)	14.7	5.0	10.0	0.55±0.05	散件
DCF103M56Y5VQ6UL7A0	Y2 250~	10000	±20%	Y5V(F)	14.7	5.0	7.5	0.55±0.05	编带
DCF103M69Y5VG6BL0AJ	Y1 250~	10000	±20%	Y5V(F)	18.0	6.0	10.0	0.55±0.05	散件
DCF103M69Y5VG8UL0L0	Y1 250~	10000	±20%	Y5V(F)	18.0	6.0	10.0	0.78±0.05	编带
DCF103Z56Y5VQ6JK7AB	Y2 250~	10000	+80%-20%	Y5V(F)	14.7	5.0	7.5	0.55±0.05	散件
DCF152M30Y5UG6BL0A0	Y1 250~	1500	±20%	Y5U(E)	7.8	6.0	10.0	0.55±0.05	散件
DCF152M30Y5UG6UK0A0	Y1 250~	1500	±20%	Y5U(E)	7.8	6.0	10.0	0.55±0.05	编带
DCF152M30Y5UQ6BL7A0	Y2 250~	1500	±20%	Y5U(E)	7.8	5.0	7.5	0.55±0.05	散件
DCF152M36Y5UG6BL0AA	Y1 250~	1500	±20%	Y5U(E)	9.8	6.0	10.0	0.55±0.05	散件
DCF152M36Y5UG6UL0A3	Y1 250~	1500	±20%	Y5U(E)	9.8	6.0	10.0	0.55±0.05	编带
DCF152M36Y5UG6WL0A0	Y1 250~	1500	±20%	Y5U(E)	9.8	6.0	10.0	0.55±0.05	散件
DCF221K22Y5PG6VL0A0	Y1 250~	220	±10%	Y5P(B)	5.5	6.0	10.0	0.55±0.05	编带
DCF221K24Y5PG5LL0A8	Y1 250~	220	±10%	Y5P(B)	6.0	6.0	10.0	0.48±0.05	散件
DCF221K24Y5PG6VL0DM	Y1 250~	220	±10%	Y5P(B)	6.0	6.0	10.0	0.55±0.05	编带
DCF221K26Y5PG6GL0A0	Y1 250~	220	±10%	Y5P(B)	6.8	6.0	10.0	0.55±0.05	散件
DCF221K26Y5PG6VL0A0	Y1 250~	220	±10%	Y5P(B)	6.8	6.0	10.0	0.55±0.05	编带
DCF221K26Y5PQ6BL7A6	Y2 250~	220	±10%	Y5P(B)	6.8	5.0	7.5	0.55±0.05	散件
DCF221K30Y5PG6JK0AB	Y1 250~	220	±10%	Y5P(B)	7.8	6.0	10.0	0.55±0.05	散件
DCF221K30Y5PG6VK0BT	Y1 250~	220	±10%	Y5P(B)	7.8	6.0	10.0	0.55±0.05	编带
DCF222M30Y5UQ6BL7A0	Y2 250~	2200	±20%	Y5U(E)	7.8	5.0	7.5	0.55±0.05	散件
DCF222M30Y5UQ6VL7A0	Y2 250~	2200	±20%	Y5U(E)	7.8	5.0	7.5	0.55±0.05	编带
DCF222M34Y5UG60L0L0	Y1 250~	2200	±20%	Y5U(E)	9.0	6.0	10.0	0.55±0.05	散件
DCF222M34Y5UG6BL0A0	Y1 250~	2200	±20%	Y5U(E)	9.0	6.0	10.0	0.55±0.05	散件
DCF222M34Y5UG6DL0A0	Y1 250~	2200	±20%	Y5U(E)	9.0	6.0	10.0	0.55±0.05	散件
DCF222M34Y5UG6UK0A0	Y1 250~	2200	±20%	Y5U(E)	9.0	6.0	10.0	0.55±0.05	编带
DCF222M34Y5UG6UL0A0	Y1 250~	2200	±20%	Y5U(E)	9.0	6.0	10.0	0.55±0.05	编带
DCF222M34Y5UG6UP0A0	Y1 250~	2200	±20%	Y5U(E)	9.0	6.0	10.0	0.55±0.05	编带
DCF222M34Y5UG6VL0A0	Y1 250~	2200	±20%	Y5U(E)	9.0	6.0	10.0	0.55±0.05	编带
DCF222M34Y5UG6WL0A0	Y1 250~	2200	±20%	Y5U(E)	9.0	6.0	10.0	0.55±0.05	散件
DCF222M34Y5UG6WP0A0	Y1 250~	2200	±20%	Y5U(E)	9.0	6.0	10.0	0.55±0.05	散件
DCF222M34Y5UGE4L0A0	Y1 250~	2200	±20%	Y5U(E)	9.0	6.0	10.0	0.58±0.05	散件

DCF222M34Y5UGEVL0A0	Y1 250~	2200	±20%	Y5U (E)	9.0	6.0	10.0	0.58±0.05	编带
DCF222M34Y5UGEWLOA0	Y1 250~	2200	±20%	Y5U (E)	9.0	6.0	10.0	0.58±0.05	散件
DCF222M34Y5UQ66L7A0	Y2 250~	2200	±20%	Y5U (E)	9.0	5.0	7.5	0.55±0.05	散件
DCF222M34Y5UQ6BL7A0	Y2 250~	2200	±20%	Y5U (E)	9.0	5.0	7.5	0.55±0.05	散件
DCF222M34Y5UQ6JK7A0	Y2 250~	2200	±20%	Y5U (E)	9.0	5.0	7.5	0.55±0.05	散件
DCF222M34Y5UQ6UP7A0	Y2 250~	2200	±20%	Y5U (E)	9.0	5.0	7.5	0.55±0.05	编带
DCF222M34Y5UQ6VJ7A0	Y2 250~	2200	±20%	Y5U (E)	9.0	5.0	7.5	0.55±0.05	编带
DCF222M34Y5UQEULO0A0	Y2 250~	2200	±20%	Y5U (E)	9.0	5.0	10.0	0.58±0.05	编带
DCF222M34Y5UQEVK7A0	Y2 250~	2200	±20%	Y5U (E)	9.0	5.0	7.5	0.58±0.05	编带
DCF222M34Y5UQEWK7A0	Y2 250~	2200	±20%	Y5U (E)	9.0	5.0	7.5	0.58±0.05	散件
DCF222M34Y5UQEWL7A0	Y2 250~	2200	±20%	Y5U (E)	9.0	5.0	7.5	0.58±0.05	散件
DCF222M34Y5VG60LOA2	Y1 250~	2200	±20%	Y5V (F)	9.0	6.0	10.0	0.55±0.05	散件
DCF222M34Y5VG6JK0A0	Y1 250~	2200	±20%	Y5V (F)	9.0	6.0	10.0	0.55±0.05	散件
DCF222M34Y5VG6UL0B8	Y1 250~	2200	±20%	Y5V (F)	9.0	6.0	10.0	0.55±0.05	编带
DCF222M34Y5VG6VLOBU	Y1 250~	2200	±20%	Y5V (F)	9.0	6.0	10.0	0.55±0.05	编带
DCF222M34Y5VG6WLOA2	Y1 250~	2200	±20%	Y5V (F)	9.0	6.0	10.0	0.55±0.05	散件
DCF222M34Y5VGEULO0A0	Y1 250~	2200	±20%	Y5V (F)	9.0	6.0	10.0	0.58±0.05	编带
DCF222M34Y5VGEUL0L0	Y1 250~	2200	±20%	Y5V (F)	9.0	6.0	10.0	0.58±0.05	编带
DCF222M34Y5VQ6JL7A0	Y2 250~	2200	±20%	Y5V (F)	9.0	5.0	7.5	0.55±0.05	散件
DCF222M36Y5UG6BL0A0	Y1 250~	2200	±20%	Y5U (E)	9.8	6.0	10.0	0.55±0.05	散件
DCF222M36Y5UG6UP0CW	Y1 250~	2200	±20%	Y5U (E)	9.8	6.0	10.0	0.55±0.05	编带
DCF222M36Y5UG7DK0A0	Y1 250~	2200	±20%	Y5U (E)	9.8	6.0	10.0	0.65±0.05	散件
DCF222M36Y5UG7JK0AB	Y1 250~	2200	±20%	Y5U (E)	9.8	6.0	10.0	0.65±0.05	散件
DCF222M36Y5UG7JL0AB	Y1 250~	2200	±20%	Y5U (E)	9.8	6.0	10.0	0.65±0.05	散件
DCF222M36Y5UQ6BL7A0	Y2 250~	2200	±20%	Y5U (E)	9.8	5.0	7.5	0.55±0.05	散件
DCF222M36Y5UQ6UL7A0	Y2 250~	2200	±20%	Y5U (E)	9.8	5.0	7.5	0.55±0.05	编带
DCF222M36Y5UQ6VK7GK	Y2 250~	2200	±20%	Y5U (E)	9.8	5.0	7.5	0.55±0.05	编带
DCF222M36Y5UQ6WL7A0	Y2 250~	2200	±20%	Y5U (E)	9.8	5.0	7.5	0.55±0.05	散件
DCF222M39Y5UG6DWOA2	Y1 250~	2200	±20%	Y5U (E)	10.5	6.0	10.0	0.55±0.05	散件
DCF222M39Y5UG6JK0A0	Y1 250~	2200	±20%	Y5U (E)	10.5	6.0	10.0	0.55±0.05	散件
DCF222M39Y5UG6JL0A0	Y1 250~	2200	±20%	Y5U (E)	10.5	6.0	10.0	0.55±0.05	散件
DCF222M39Y5UG6ULO0A0	Y1 250~	2200	±20%	Y5U (E)	10.5	6.0	10.0	0.55±0.05	编带
DCF222M39Y5UG6WLOA0	Y1 250~	2200	±20%	Y5U (E)	10.5	6.0	10.0	0.55±0.05	散件
DCF222M39Y5UG6WP0A0	Y1 250~	2200	±20%	Y5U (E)	10.5	6.0	10.0	0.55±0.05	散件
DCF222M39Y5UG9VPAGB	Y1 250~	2200	±20%	Y5U (E)	10.5	6.0	10.0	0.58±0.05	编带
DCF222M39Y5UQ6WP7A0	Y2 250~	2200	±20%	Y5U (E)	10.5	5.0	7.5	0.55±0.05	散件
DCF222M46Y5UG6WP0AA	Y1 250~	2200	±20%	Y5U (E)	12.3	6.0	10.0	0.55±0.05	散件

DCF331K26Y5PG6JK0A0	Y1 250~	330	±10%	Y5P(B)	6.8	6.0	10.0	0.55±0.05	散件
DCF331K26Y5PG6JPOA0	Y1 250~	330	±10%	Y5P(B)	6.8	6.0	10.0	0.55±0.05	散件
DCF331K26Y5PG6VLAFK	Y1 250~	330	±10%	Y5P(B)	6.8	6.0	10.0	0.55±0.05	编带
DCF331K30Y5PG63L0A0	Y1 250~	330	±10%	Y5P(B)	7.8	6.0	10.0	0.55±0.05	散件
DCF331K30Y5PG6VK0BT	Y1 250~	330	±10%	Y5P(B)	7.8	6.0	10.0	0.55±0.05	编带
DCF331K30Y5PG6VPAFVW	Y1 250~	330	±10%	Y5P(B)	7.8	6.0	10.0	0.55±0.05	编带
DCF331M26Y5UG6WLOA0	Y1 250~	330	±20%	Y5U(E)	6.8	6.0	10.0	0.55±0.05	散件
DCF331M30Y5UG63P1A2	Y1 250~	330	±20%	Y5U(E)	7.8	6.0	10.5	0.55±0.05	散件
DCF332M36Y5UQ6BL7A0	Y2 250~	3300	±20%	Y5U(E)	9.8	5.0	7.5	0.55±0.05	散件
DCF332M36Y5UQ6JK7A0	Y2 250~	3300	±20%	Y5U(E)	9.8	5.0	7.5	0.55±0.05	散件
DCF332M36Y5VQ6UP7A0	Y2 250~	3300	±20%	Y5V(F)	9.8	5.0	7.5	0.55±0.05	编带
DCF332M36Y5VQ6VLOA0	Y2 250~	3300	±20%	Y5V(F)	9.8	5.0	10.0	0.55±0.05	编带
DCF332M36Y5VQ6VL7A0	Y2 250~	3300	±20%	Y5V(F)	9.8	5.0	7.5	0.55±0.05	编带
DCF332M36Y5VQ6WL7A2	Y2 250~	3300	±20%	Y5V(F)	9.8	5.0	7.5	0.55±0.05	散件
DCF332M39Y5UG6BLOA0	Y1 250~	3300	±20%	Y5U(E)	10.5	6.0	10.0	0.55±0.05	散件
DCF332M39Y5UG6JK0A0	Y1 250~	3300	±20%	Y5U(E)	10.5	6.0	10.0	0.55±0.05	散件
DCF332M39Y5UG6WK0A0	Y1 250~	3300	±20%	Y5U(E)	10.5	6.0	10.0	0.55±0.05	散件
DCF332M39Y5UG6WLOA0	Y1 250~	3300	±20%	Y5U(E)	10.5	6.0	10.0	0.55±0.05	散件
DCF332M39Y5UG7JK0AB	Y1 250~	3300	±20%	Y5U(E)	10.5	6.0	10.0	0.65±0.05	散件
DCF332M46Y5UQ60L7AA	Y2 250~	3300	±20%	Y5U(E)	12.3	5.0	7.5	0.55±0.05	散件
DCF332M46Y5UQ6WP7A0	Y2 250~	3300	±20%	Y5U(E)	12.3	5.0	7.5	0.55±0.05	散件
DCF470K26Y5PG6ALOA0	Y1 250~	47	±10%	Y5P(B)	6.8	6.0	10.0	0.55±0.05	散件
DCF470K30SL G6VK0BT	Y1 250~	47	±10%	SL	7.8	6.0	10.0	0.55±0.05	编带
DCF471K26Y5PG6BLOA0	Y1 250~	470	±10%	Y5P(B)	6.8	6.0	10.0	0.55±0.05	散件
DCF471K26Y5PG6VLOA0	Y1 250~	470	±10%	Y5P(B)	6.8	6.0	10.0	0.55±0.05	编带
DCF471K26Y5PG6WLOA0	Y1 250~	470	±10%	Y5P(B)	6.8	6.0	10.0	0.55±0.05	散件
DCF471K26Y5PQ6VL7A0	Y2 250~	470	±10%	Y5P(B)	6.8	5.0	7.5	0.55±0.05	编带
DCF471K30Y5PQ6BL7A0	Y2 250~	470	±10%	Y5P(B)	7.8	5.0	7.5	0.55±0.05	散件
DCF471K30Y5PQ6VK7A0	Y2 250~	470	±10%	Y5P(B)	7.8	5.0	7.5	0.55±0.05	编带
DCF471K30Y5PQ6VL7A6	Y2 250~	470	±10%	Y5P(B)	7.8	5.0	7.5	0.58±0.05	编带
DCF471K34Y5PG62P0A0	Y1 250~	470	±10%	Y5P(B)	9.0	6.0	10.0	0.55±0.05	散件
DCF471K34Y5PG6JK0A0	Y1 250~	470	±10%	Y5P(B)	9.0	6.0	10.0	0.55±0.05	散件
DCF471K34Y5PG6ULOA0	Y1 250~	470	±10%	Y5P(B)	9.0	6.0	10.0	0.55±0.05	编带
DCF471K34Y5PG6UP0A0	Y1 250~	470	±10%	Y5P(B)	9.0	6.0	10.0	0.55±0.05	编带
DCF471K34Y5PG6VK0A0	Y1 250~	470	±10%	Y5P(B)	9.0	6.0	10.0	0.55±0.05	编带
DCF471K34Y5PG6WLOA0	Y1 250~	470	±10%	Y5P(B)	9.0	6.0	10.0	0.55±0.05	散件
DCF471K34Y5PGEVL0L0	Y1 250~	470	±10%	Y5P(B)	9.0	6.0	10.0	0.58±0.05	编带



DCF471M26Y5UG6BLOA0	Y1 250~	470	±20%	Y5U(E)	6.8	6.0	10.0	0.55±0.05	散件
DCF471M26Y5UG6JKOA0	Y1 250~	470	±20%	Y5U(E)	6.8	6.0	10.0	0.55±0.05	散件
DCF471M26Y5UG6VLAGA	Y1 250~	470	±20%	Y5U(E)	6.8	6.0	10.0	0.55±0.05	编带
DCF471M26Y5UG6WLOA0	Y1 250~	470	±20%	Y5U(E)	6.8	6.0	10.0	0.55±0.05	散件
DCF471M34Y5UG6WPOA0	Y1 250~	470	±20%	Y5U(E)	9.0	6.0	10.0	0.55±0.05	散件
DCF472M39Y5UQ6BL7A0	Y2 250~	4700	±20%	Y5U(E)	10.5	5.0	7.5	0.55±0.05	散件
DCF472M39Y5UQ6JK7A0	Y2 250~	4700	±20%	Y5U(E)	10.5	5.0	7.5	0.55±0.05	散件
DCF472M39Y5UQ6UL7A0	Y2 250~	4700	±20%	Y5U(E)	10.5	5.0	7.5	0.55±0.05	编带
DCF472M39Y5UQ6VL7BU	Y2 250~	4700	±20%	Y5U(E)	10.5	5.0	7.5	0.55±0.05	编带
DCF472M39Y5UQ6WK7A0	Y2 250~	4700	±20%	Y5U(E)	10.5	5.0	7.5	0.55±0.05	散件
DCF472M39Y5UQ6WL7A0	Y2 250~	4700	±20%	Y5U(E)	10.5	5.0	7.5	0.55±0.05	散件
DCF472M39Y5UQ6WP7A0	Y2 250~	4700	±20%	Y5U(E)	10.5	5.0	7.5	0.55±0.05	散件
DCF472M39Y5VQ6BLOA0	Y2 250~	4700	±20%	Y5V(F)	10.5	5.0	10.0	0.55±0.05	散件
DCF472M39Y5VQ6JK7A0	Y2 250~	4700	±20%	Y5V(F)	10.5	5.0	7.5	0.55±0.05	散件
DCF472M39Y5VQ6JL7A0	Y2 250~	4700	±20%	Y5V(F)	10.5	5.0	7.5	0.55±0.05	散件
DCF472M46Y5UG6BLOA0	Y1 250~	4700	±20%	Y5U(E)	12.3	6.0	10.0	0.55±0.05	散件
DCF472M46Y5UG6JLOA0	Y1 250~	4700	±20%	Y5U(E)	12.3	6.0	10.0	0.55±0.05	散件
DCF472M46Y5VG6BLOLO	Y1 250~	4700	±20%	Y5V(F)	12.3	6.0	10.0	0.55±0.05	散件
DCF472M46Y5VG6ULOBU	Y1 250~	4700	±20%	Y5V(F)	12.3	6.0	10.0	0.55±0.05	编带
DCF472M46Y5VG6VLOLO	Y1 250~	4700	±20%	Y5V(F)	12.3	6.0	10.0	0.55±0.05	编带
DCF472M46Y5VG6WLOA0	Y1 250~	4700	±20%	Y5V(F)	12.3	6.0	10.0	0.55±0.05	散件
DCF472M46Y5VGCWLOLO	Y1 250~	4700	±20%	Y5V(F)	12.3	6.0	10.0	0.65±0.05	散件
DCF472M53Y5UQ69L7A0	Y2 250~	4700	±20%	Y5U(E)	14.0	5.0	7.5	0.55±0.05	散件
DCF472M56Y5UG6WLOA0	Y1 250~	4700	±20%	Y5U(E)	14.7	6.0	10.0	0.55±0.05	散件
DCF472M56Y5UG6WPOA0	Y1 250~	4700	±20%	Y5U(E)	14.7	6.0	10.0	0.55±0.05	散件
DCF680K24Y5PG5LL9CV	Y1 250~	68	±10%	Y5P(B)	6.0	6.0	9.0	0.48±0.05	散件
DCF681K30Y5UG6JP0A0	Y1 250~	680	±10%	Y5U(E)	7.8	6.0	10.0	0.55±0.05	散件
DCF681K30Y5UG9VPAGB	Y1 250~	680	±10%	Y5U(E)	7.8	6.0	10.0	0.58±0.05	编带
DCF681K36Y5PG6BLOA0	Y1 250~	680	±10%	Y5P(B)	9.8	6.0	10.0	0.55±0.05	散件
DCF681K36Y5PG6JKOA0	Y1 250~	680	±10%	Y5P(B)	9.8	6.0	10.0	0.55±0.05	散件
DCF681K36Y5PG6WLOA0	Y1 250~	680	±10%	Y5P(B)	9.8	6.0	10.0	0.55±0.05	散件
DCF681K36Y5PGEULOAO	Y1 250~	680	±10%	Y5P(B)	9.8	6.0	10.0	0.58±0.05	编带
DCF681M30Y5UG63LOA0	Y1 250~	680	±20%	Y5U(E)	7.8	6.0	10.0	0.55±0.05	散件
DCF681M30Y5UG6JKOA0	Y1 250~	680	±20%	Y5U(E)	7.8	6.0	10.0	0.55±0.05	散件
DCF681M30Y5UG6UKOA0	Y1 250~	680	±20%	Y5U(E)	7.8	6.0	10.0	0.55±0.05	编带



电性能指标 Electrical Performance

序号 No.	项目名称 Item		技术要求 Specification	
1	容量和误差 C		@25°C, 1 kHz and 1 Vrms	参照规格表 See the specification
2	损耗系数 DF		@25°C, 1 kHz and 1 Vrms	2.5% max.
3	绝缘电阻 IR		@500 VDC, 60S	10000MΩmin
4	耐电压 Rate Voltage	X1/Y2	2600Vrms	无击穿或飞弧。 No visible damage
		X1/Y1	2500Vrms	
5	温度特性 temperature characteristic	Y5P		±10%
		Y5U		+22% to -56%
		Y5V		+22% to -82%

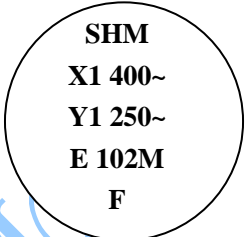
标志 Marking

例如 e.g

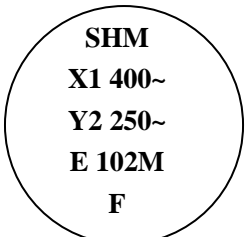
Y1 电容器	
正面	反面
	

Y2 电容器	
正面	反面
	

TAPING STYLE V

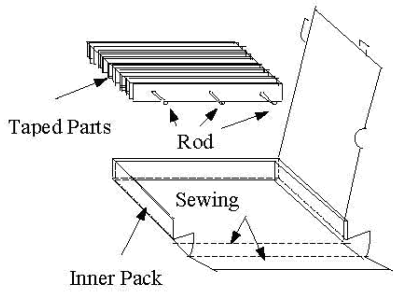
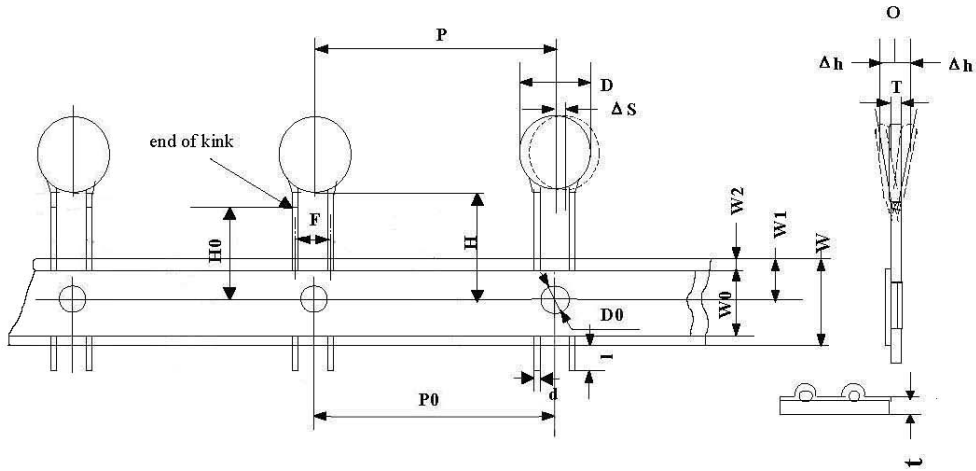

Symbol	Dimension(mm)
P0	15.0±0.2
P	15.0±1.0
F	10.0±0.5
P1	
P2	
H0	16.0±0.5*1
H	20.0±0.5*2
W	18.0±0.5
W0	8.0min.
W1	9.0±0.3
W2	3.0max.
t	0.7±0.2
D	To comply with individual sheet
D0	4±0.2
d	To comply with individual sheet
l	2.0max.
T	To comply with individual sheet
ΔS	1.0 max.
Δh	1.0 max.

1. *1 打弯脚型以H0为准。

For kink lead only.

2. *2 直脚产品以H为准。

For straight lead only.

Figure 3

TAPING STYLE U

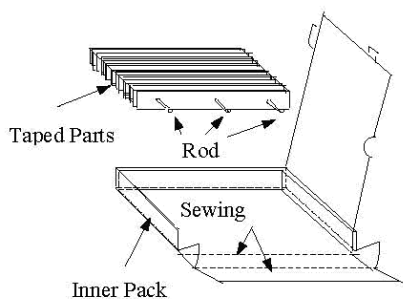
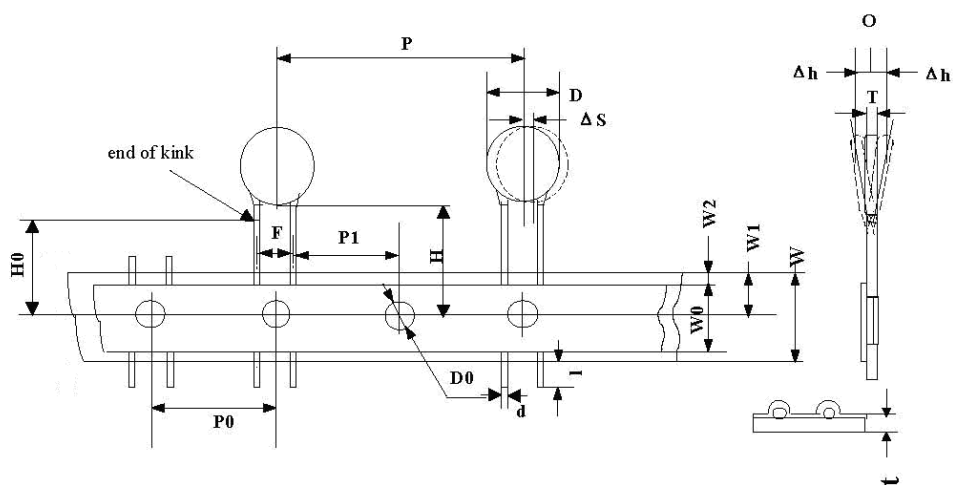

Symbol	Dimension(mm)
P0	12.7±0.2
P	25.4±1.0
F	10.0±0.5
P1	7.7±0.4
P2	
H0	16.0±0.5*1
H	20.0±0.5*2
W	18.0±0.5
W0	8.0min.
W1	9.0±0.3
W2	3.0max.
t	0.7±0.2
D	To comply with individual sheet
D0	4±0.2
d	To comply with individual sheet
l	2.0max.
T	To comply with individual sheet
Δ S	1.0 max.
Δ h	1.0 max.

1. *1 打弯脚型以H0为准。

For kink lead only.

2. *2 直脚产品以H为准。

For straight lead only.

Figure 6

X-ON Electronics

Largest Supplier of Electrical and Electronic Components

Click to view similar products for [Safety Capacitors](#) category:

Click to view products by [South HongMing](#) manufacturer:

Other Similar products are found below :

[B32022B3223K026](#) [B32912A3104K026](#) [B81123C1102M003](#) [MKPY2-.02230020P15](#) [46KN333000M1M](#) [46KN422000P0M](#)
[46KR422000M1K](#) [MP1125KRE6RLC](#) [MP2683KGC2XLC](#) [MP2124KGC3XLC](#) [MP2684KGD4XLC](#) [MP2474KGE1XLC](#) [46KF268000M1M](#)
[46KI3150NDM2M](#) [PHE840MD6220MD13R30](#) [PHE840MY6470MD14R06](#) [PHE845VD5470MR06](#) [R463N4100ZAM1K](#) [MKPX2R-](#)
[1/400/10P27](#) [YP500101K040B20C2P](#) [YU0AH222M090DAMD0B](#) [LS1808N102K302NX080TM](#) [CY1471KE1IEB46X2A2](#)
[CY1222ME5IEE48O2A2](#) [MPX474K31DTEV158G0](#) [Y2560K-D1I-B4-AC250V](#) [HMF222MG3BW](#) [CY1471ME19EE45W2A2](#)
[MPX104K31D2KN158HF](#) [MPX224K31D2KN158G0](#) [PX104K2W1502](#) [MP2224K32C5J6LC](#) [H102M050FQ55250L750A](#)
[MP2474K32D6R8LC](#) [MP2224K32C3J6LC](#) [MP2104K32C3J6LC](#) [PX334K2C1006](#) [YU0AC222M080L20C7B](#) [MP2473K27B2X6LC](#)
[MP2224K32D4J8LC](#) [MP2684K32D6T8LC](#) [ST3Y1Y5U332M500VAC](#) [ST3Y1Y5V472M500VAC](#) [MP2474K32D4X8LC](#)
[MP2474K32D4J8LC](#) [YU0AH332M110L4EB0B](#) [CY1681ME1IEE45S2A2](#) [Y1220J-E1I-B4-AC400V](#) [Y1120K-E1I-B4-AC400V](#)
[MP2154K32D2R8LC](#)