

DCM中压瓷介电容器

DCM Middle Voltage Ceramic Capacitors

特性 Feature

- 容量范围 Wide capacitance range from 1pF to 10000pF
- 工作温度 Operating Temperature: -25℃~85℃
- 存储温度 Storage Temperature: -10℃~40℃

应用 Applications

DCM 型中压圆片瓷介电容器的 I 类 (温度特性 CO 和 SL) 适用于调谐回路和需要补偿温度效应的电路中, II 类 (温度特性 Y5P、Y5U、Z5U、Y5V) 适用于旁路、滤波、耦合、隔直流等电路中。

In the class I (CO and SL Temperature characteristic), DCM capacitors allow the Temperature compensating disc capacitors to be used in critical circuit application such as tuned circuits, CLASS II(Y5P,Y5U,Z5U,Y5V Temperature characteristic) capacitors are fit for the circuit such as bypass, filter, coupling etc, Where a large amount of Capacitance is required and the circuit is less sensitive to Capacitance change with Temperature variations.

产品型号 Part Number

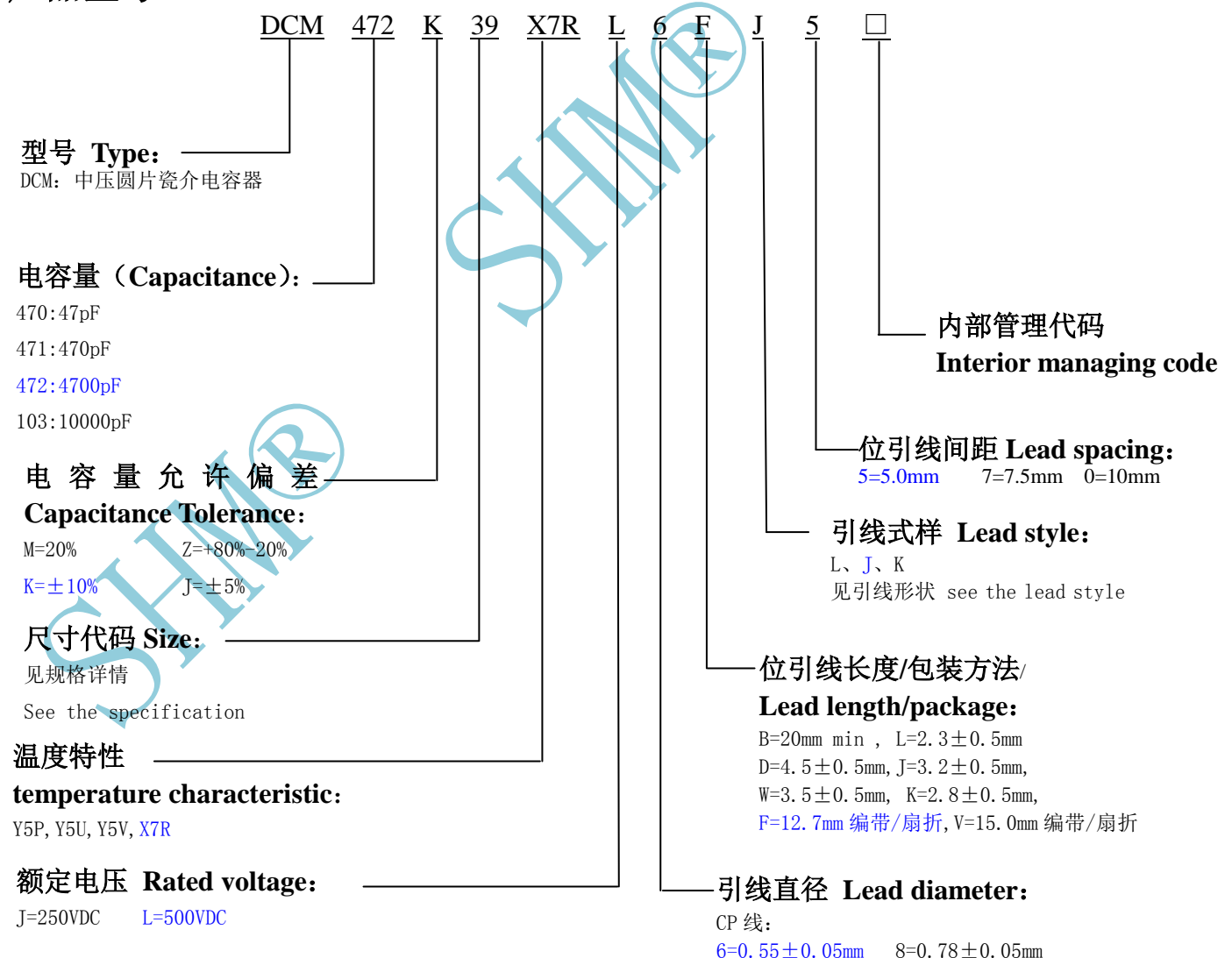

脚型 Lead style

STYLE: J

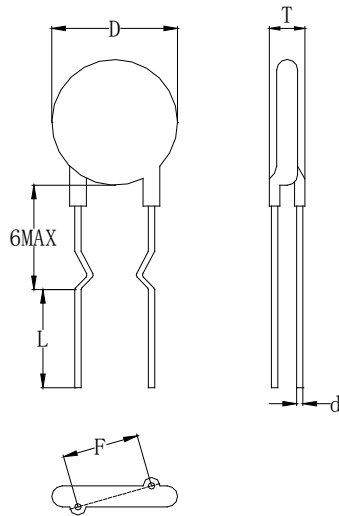

规格 Specification



SHM 产品代码 SHM Part No.	额定电压 Rated voltage (VDC)	标称容量 Nominal capacitance (pF)	电容量允许偏差范围 Tolerance (%)	温度特性 Temperature Characteristic	产品尺寸(mm)				
					直径 Dmax. (mm)	厚度 Tmax. (mm)	引线间距 F(mm)	引线直径 d (mm)	引线长度 L (mm)/编带方式
DCM472K39X7RL6FJ5B8	500	4700	±10%	X7R	10.5	4.0	5.0±0.5	0.55±0.05	F 编带

电性能指标 Electrical Performance

序号 No.	项目名称 Item	技术要求 Specification	
1	容量和误差 C	@25°C, 1 kHz and 1 Vrms	参照规格表 See the specification
2	损耗系数 DF	@25°C, 1 kHz and 1 Vrms	3.5% max.
3	绝缘电阻 IR	@500 VDC, 60S	10000MΩ min
4	耐电压 Rate Voltage	300%额定电压 (3*500VDC=1500VDC)	无击穿或飞弧。 No visible damage
5	温度特性 temperature characteristic	X7R	±15%
		Y5P	±10%
		Y5U	+22% to -56%
		Y5V	+22% to -82%

标志 Marking

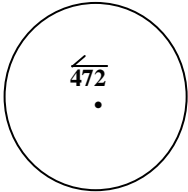
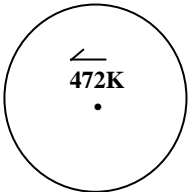
例如 e.g

产品	22#号产品及以下 ≤ 22#	24#, 26#号产品	30#产品以上 ≥30#
正面 Front			
反面 Back	空白 Blank	空白 Blank	空白 Blank

TAPING STYLE F

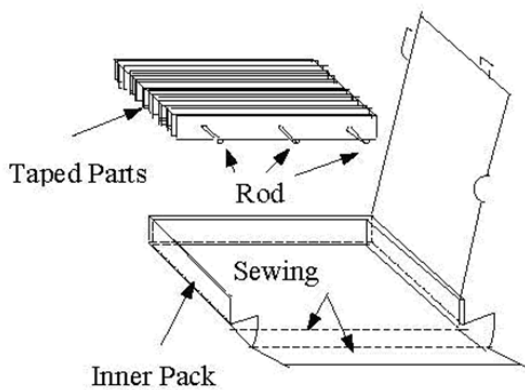
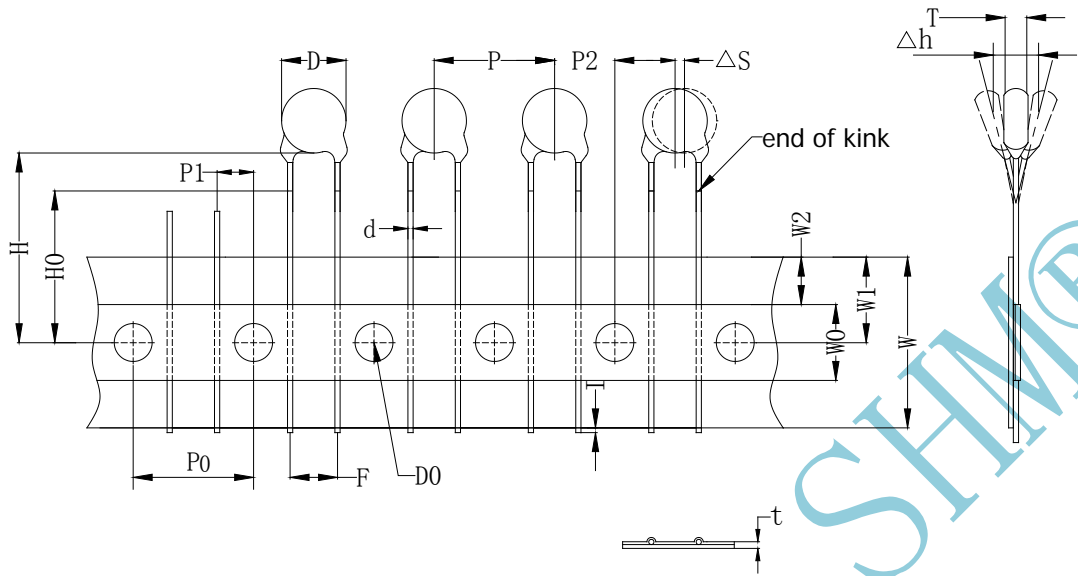

- 1.*打弯脚型以 H0 为准。
 For kink lead only.
 2.*直脚产品以 H 为准。
 For straight lead only.

Symbol	Dimension(mm)
P0	12.7±0.2
P	12.7±1.0
F	5.0±0.5
P1	3.85±0.4
P2	6.35±0.4
H0	17.0+1.0/0.5*1
H	20.0±1.0*2
W	18.0±0.5
W0	8.0min.
W1	9.0±0.3
W2	3.0max.
t	0.7±0.2
D	To comply with individual sheet
D0	4.0±0.2
d	To comply with individual sheet
l	2.0max.
T	To comply with individual sheet
ΔS	1.0max.
Δh	1.0max.

X-ON Electronics

Largest Supplier of Electrical and Electronic Components

Click to view similar products for [Safety Capacitors](#) category:

Click to view products by [South HongMing](#) manufacturer:

Other Similar products are found below :

[B32022B3223K026](#) [B32912A3104K026](#) [46KI3470DQM1K](#) [B32913A3154K](#) [B81123C1102M003](#) [MKPY2-.02230020P15](#)
[46KN333000M1M](#) [46KN422000P0M](#) [DE1E3KX222MJ4BN01F](#) [46KR422000M1K](#) [HUB2200-S](#) [46KF268000M1M](#) [46KI3150NDM2M](#)
[PHE840MD6220MD13R30](#) [PHE840MY6470MD14R06](#) [PHE845VD5470MR06](#) [R463N4100ZAM1K](#) [MKPX2R-1/400/10P27](#)
[YP500101K040B20C2P](#) [YU0AH222M090DAMD0B](#) [LS1808N102K302NX080TM](#) [CY1471KE1IEB46X2A2](#) [CY1222ME5IEE48O2A2](#)
[MPX474K31DTEV158G0](#) [CY1471ME19EE45W2A2](#) [MPX104K31D2KN158HF](#) [MPX224K31D2KN158G0](#) [PX104K2W1502](#)
[YU1AH222M090DASD0H](#) [C47S1472K60C000](#) [MP2224K32C5J6LC](#) [H102M050FQ55250L750A](#) [MP2474K32D6R8LC](#)
[MP2224K32C3J6LC](#) [MP2104K32C3J6LC](#) [PX334K2C1006](#) [YU0AC222M080L20C7B](#) [MP2473K27B2X6LC](#) [MP2224K32D4J8LC](#)
[MP2684K32D6T8LC](#) [ST3Y1Y5U332M500VAC](#) [ST3Y1Y5V472M500VAC](#) [MP2474K32D4X8LC](#) [MP2474K32D4J8LC](#)
[YU0AH332M110L4EB0B](#) [CY1681ME1IEE45S2A2](#) [Y1220J-E1I-B4-AC400V](#) [Y1120K-E1I-B4-AC400V](#) [MP2154K32D2R8LC](#)
[ST1Y1Y5V222M500VAC](#)