

# 压敏电阻器 Zinc oxide varistors



## 特性 Feature

- 电压范围 Wide operation voltage range from 18V to 1800V
- 工作温度 Operating Temperature: -40°C~125°C
- 存储温度 Storage Temperature: -10°C~40°C

## 应用 Applications

氧化锌压敏电阻器广泛应用于电子电器设备的瞬时过电压保护和浪涌吸收。  
Zinc oxide varistor is widely used in the instantaneous overvoltage protection and surge absorption of Electronic-electrical equipment.

## 使用标准Applicable Standard

通过认证 APPROVAL	认证组织 ORGANIZATION	标准. SAFTY STANDARDS	证书 CERTIFICATE NO.
	<b>UL CUL</b>	UL1449	E321851
	<b>VDE</b>	DIN EN 61051-1:2009 IEC 61051-1:2007 IEC 61051-2:1991 IEC 61051-2(ed.1);am1:2009-05 IEC 61051-2-2:1991	40027789
	<b>CQC</b>	GB/T10193-1997 GB/T10194-1997 GB4943.1-2011 GB8898-2011	CQC05001012670

## 产品型号Part Number

产品型号 Part No.: **ZVR 07 D 471 K L 6 3 5** □

产品尺寸 Size code: **07**

代号: 芯片直径 产品直径(D)  
Code disc diameter product diameter  
05 5mm±0.5mm 6mm±1mm  
07 7mm±0.5mm 8mm±1mm  
10 10mm±0.5mm 11mm±1.5mm  
14 14mm±0.5mm 15mm±1.5mm  
20 20mm±0.5mm 21mm±1.5mm

产品类别代码 Shape code: **D**  
代号 D: 圆片通用型产品  
D: disc for general

称压敏电压 varistor voltage: **471**  
For example:  
180=18x10<sup>0</sup> 471=47x10<sup>1</sup> 102=10x10<sup>2</sup>

内部管理代码: internal manage code

引线间距 lead space:  
5=5.0±0.5mm 7=7.5±0.5mm 0=10.0±0.5mm

引线长度/包装方法 lead length/package:  
3=3.5±0.5mm B= min. 25mm C=5.0±0.3mm  
F=12.7mm 编带/扇折,

引线直径 lead diameter:  
CP 线:  
6=0.58±0.04mm 8=0.78±0.05mm  
0=1.00±0.08mm

引线形状代码 lead style:  
L 型 见引线形状 see the lead style

压敏电压允许偏差  
Varistor voltage tolerance:  
J=±5% K=±10% M=±20%

# 脚型 Lead style



Figure 1-2



Figure 1-3

## 规格 Specification

SHM 产品代码 SHM Part no.	压敏电压 Varistor Voltage (V)	最大允许工作电压 Maximum Operating Voltage		最大限制电压 Maximum Clamping Voltage		最大峰值电流 Maximum Peak current 8/20 $\mu$ s Ip (A)		产品尺寸 dimensions (mm)				
		AC (V)	DC (V)	VC (V)	Ip (A)	1 Time	2 Time	直径 D (mm)	厚度 Tmax (mm)	引线间距 F (mm)	引线直径 d (mm)	引线长度 L (mm)/编带方式
ZVR05D471KK6F5A0	470	300	380	810	5	400	200	6 $\pm$ 1	5.8	5.0	0.55	F 型编带
ZVR07D201KL695A0	200	130	170	340	10	1250	800	8 $\pm$ 1	4.1	5.0	0.55	9.0 $\pm$ 1.0
ZVR07D241KK6F5A0	240	150	200	395	10	1250	800	8 $\pm$ 1	4.4	5.0	0.55	F 型编带
ZVR07D241KL6C5A0	240	150	200	395	10	1250	800	8 $\pm$ 1	4.4	5.0	0.55	3.2 $\pm$ 0.3
ZVR07D271KK6F5A0	270	175	225	455	10	1250	800	8 $\pm$ 1	4.6	5.0	0.55	F 型编带
ZVR07D271KL6C5A0	270	175	225	455	10	1250	800	8 $\pm$ 1	4.6	5.0	0.55	3.2 $\pm$ 0.3
ZVR07D331KL635A0	330	210	276	572	10	1250	800	8 $\pm$ 1	5.0	5.0	0.55	3.5 $\pm$ 0.5
ZVR07D391KK6F5F1	390	250	320	650	10	1250	800	8 $\pm$ 1	5.4	5.0	0.55	F 型编带
ZVR07D431KL6F5A0	430	275	350	710	10	1250	800	8 $\pm$ 1	5.6	5.0	0.55	F 型编带
ZVR07D431KL6F5F1	430	275	350	710	10	1250	800	8 $\pm$ 1	5.6	5.0	0.55	F 型编带
ZVR07D431KP635A0J	430	275	350	710	10	1750	1250	8 $\pm$ 1	5.6	5.0	0.55	3.5 $\pm$ 0.5
ZVR07D431KP6F5A0	430	275	350	710	10	1250	800	8 $\pm$ 1	5.6	5.0	0.55	F 型编带
ZVR07D431KP6F5A0J	430	275	350	710	10	1750	1250	8 $\pm$ 1	5.6	5.0	0.55	F 型编带
ZVR07D470KK6F5A0	47	30	38	93	2.5	250	125	8 $\pm$ 1	4.3	5.0	0.55	F 型编带
ZVR07D471KK635A0	470	300	385	775	10	1250	800	8 $\pm$ 1	5.8	5.0	0.55	3.5 $\pm$ 0.5
ZVR07D471KK6F5F1	470	300	385	775	10	1250	800	8 $\pm$ 1	5.8	5.0	0.55	F 型编带
ZVR07D471KL645A0	470	300	385	775	10	1250	800	8 $\pm$ 1	5.8	5.0	0.55	4.0 $\pm$ 0.5
ZVR07D471KL6B5A0	470	300	385	775	10	1250	800	8 $\pm$ 1	5.8	5.0	0.55	25min
ZVR07D471KL6C5A0	470	300	385	775	10	1250	800	8 $\pm$ 1	5.8	5.0	0.55	3.2 $\pm$ 0.3

ZVR07D471KL6F5A0	470	300	385	775	10	1250	800	8±1	5.8	5.0	0.55	F 型编带
ZVR07D471KL6F5F1	470	300	385	775	10	1250	800	8±1	5.8	5.0	0.55	F 型编带
ZVR07D471KP6F5A0	470	300	385	775	10	1250	800	8±1	5.8	5.0	0.55	F 型编带
ZVR07D511KJ6F5A0	510	320	430	845	10	1250	800	8±1	6.0	5.0	0.55	F 型编带
ZVR07D511KK6F5A0	510	320	430	845	10	1250	800	8±1	6.0	5.0	0.55	F 型编带
ZVR07D511KL635A0	510	320	430	845	10	1250	800	8±1	6.0	5.0	0.55	3.5±0.5
ZVR07D511KL645A0	510	320	430	845	10	1250	800	8±1	6.0	5.0	0.55	4.0±0.5
ZVR07D511KL835A0	510	320	430	845	10	1250	800	8±1	6.0	5.0	0.78	3.5±0.5
ZVR07D560KJ6B5A0	56	35	45	110	2.5	250	125	8±1	4.4	5.0	0.55	25min
ZVR07D561KK6V7A0	560	356	468	925	10	1250	800	8±1	6.2	7.5	0.55	V 型编带
ZVR07D561KL655A0	560	356	468	925	10	1250	800	8±1	6.2	5.0	0.55	5.0±0.5
ZVR07D561KP6F5A0	560	356	468	925	10	1250	800	8±1	6.2	5.0	0.55	F 型编带
ZVR10D241KK6V7A0	240	150	200	395	25	2500	1750	11±1	4.8	7.5	0.55	V 型编带
ZVR10D241KL638A0	240	150	200	395	25	2500	1750	11±1	4.8	8	0.55	3.5±0.5
ZVR10D271KL8V7A0	270	175	225	455	25	2500	1750	11±1	5.1	7.5	0.78	V 型编带
ZVR10D361KL837A0	360	230	300	595	25	2500	1750	11±1	5.7	7.5	0.78	3.5±0.5
ZVR10D391KL7B7A0	390	250	320	650	25	2500	1750	11±1	5.8	7.5	0.65	25min
ZVR10D391KL837A0	390	250	320	650	25	2500	1750	11±1	5.8	7.5	0.78	3.5±0.5
ZVR10D391KL8B7A0	390	250	320	650	25	2500	1750	11±1	5.8	7.5	0.78	25min
ZVR10D391KP857A0	390	250	320	650	25	2500	1750	11±1	5.8	7.5	0.78	5.0±0.5
ZVR10D431KL837A0	430	275	350	710	25	2500	1750	11±1	5.9	7.5	0.78	3.5±0.5
ZVR10D431KL837A0J	430	275	350	710	25	3500	2500	11±1	5.9	7.5	0.78	3.5±0.5
ZVR10D471KK837A0	470	300	385	775	25	2500	1750	11±1	6.0	7.5	0.78	3.5±0.5
ZVR10D471KK837F1	470	300	385	775	25	2500	1750	11±1	6.0	7.5	0.78	3.5±0.5
ZVR10D471KK8C7A0G	470	300	385	775	25	3500	2500	13±1	6.0	7.5	0.78	3.2±0.3
ZVR10D471KK8U7A0J	470	300	385	775	25	3500	2500	11±1	6.0	7.5	0.78	U 型编带
ZVR10D471KL6B8A0	470	300	385	775	25	2500	1750	11±1	6.0	8	0.55	25min
ZVR10D471KL82JA0	470	300	385	775	25	2500	1750	11±1	6.0	7.5	0.78	2.8±0.4
ZVR10D471KL837A0	470	300	385	775	25	2500	1750	11±1	6.0	7.5	0.78	3.5±0.5
ZVR10D471KL847A0	470	300	385	775	25	2500	1750	11±1	6.0	7.5	0.78	4.0±0.5
ZVR10D471KL877A0	470	300	385	775	25	2500	1750	11±1	6.0	7.5	0.78	7.0±0.5
ZVR10D471KL87FA0	470	300	385	775	25	2500	1750	11±1	6.0	7.7	0.78	7.0±0.5
ZVR10D471KL8B7A0	470	300	385	775	25	2500	1750	11±1	6.0	7.5	0.78	25min
ZVR10D471KL8C7A0	470	300	385	775	25	2500	1750	11±1	6.0	7.5	0.78	3.2±0.3

ZVR10D471KL8C7A0G	470	300	385	775	25	3500	2500	13±1	6.0	7.5	0.78	3.2±0.3
ZVR10D471KL8U7A0	470	300	385	775	25	2500	1750	11±1	6.0	7.5	0.78	U 型编带
ZVR10D471KL8V7A0	470	300	385	775	25	2500	1750	11±1	6.0	7.5	0.78	V 型编带
ZVR10D471KP7F5F1	470	300	385	775	25	2500	1750	11±1	6.0	5.0	0.65	F 型编带
ZVR10D511KK837A0J	510	320	430	840	25	3500	2500	11±1	6.2	7.5	0.78	3.5±0.5
ZVR10D511KL837A0	510	320	430	840	25	2500	1750	11±1	6.2	7.5	0.78	3.5±0.5
ZVR10D511KL8B7A0	510	320	430	840	25	2500	1750	11±1	6.2	7.5	0.78	25min
ZVR10D511KL8B7A0J	510	320	430	840	25	3500	2500	11±1	6.2	7.5	0.78	25min
ZVR10D561KK837A0	560	356	468	925	25	2500	1750	11±1	6.4	7.5	0.78	3.5±0.5
ZVR10D561KK837A0J	560	356	468	925	25	3500	2500	11±1	6.4	7.5	0.78	3.5±0.5
ZVR10D561KK837F1	560	356	468	925	25	2500	1750	11±1	6.4	7.5	0.78	3.5±0.5
ZVR10D561KK8C7A0G	560	356	468	925	25	3500	2500	13±1	6.4	7.5	0.78	3.2±0.3
ZVR10D561KKDV7A0J	560	356	468	925	25	3500	2500	11±1	6.4	7.5	0.78	V 型编带
ZVR10D561KL638A0	560	356	468	925	25	2500	1750	11±1	6.4	8	0.55	3.5±0.5
ZVR10D561KL648A0	560	356	468	925	25	2500	1750	11±1	6.4	8	0.55	4.0±0.5
ZVR10D561KL827A8J	560	356	468	925	25	3500	2500	11±1	6.4	7.5	0.78	2.8±0.4
ZVR10D561KL837A0	560	356	468	925	25	2500	1750	11±1	6.4	7.5	0.78	3.5±0.5
ZVR10D561KL837A0G	560	356	468	925	25	3500	2500	13±1	6.4	7.5	0.78	3.5±0.5
ZVR10D561KL837A0J	560	356	468	925	25	3500	2500	11±1	6.4	7.5	0.78	3.5±0.5
ZVR10D561KL837E0	560	356	468	925	25	2500	1750	11±1	6.4	7.5	0.78	3.5±0.5
ZVR10D561KL857A0	560	356	468	925	25	2500	1750	11±1	6.4	7.5	0.78	5.0±0.5
ZVR10D561KL8B7A0	560	356	468	925	25	2500	1750	11±1	6.4	7.5	0.78	25min
ZVR10D561KL8C7A0	560	356	468	925	25	2500	1750	11±1	6.4	7.5	0.78	3.2±0.3
ZVR10D561KL8C7A0G	560	356	468	925	25	3500	2500	13±1	6.4	7.5	0.78	3.2±0.3
ZVR10D561KL8D7A0	560	356	468	925	25	2500	1750	11±1	6.4	7.5	0.78	3.0±0.5
ZVR10D561KP8V7A0	560	356	468	925	25	2500	1750	11±1	6.4	7.5	0.78	V 型编带
ZVR10D621KL837A0	620	385	505	1025	25	2500	1750	11±1	6.6	7.5	0.78	3.5±0.5
ZVR10D621KL8D7A0G	620	385	505	1025	25	3500	2500	13±1	6.6	7.5	0.78	3.0±0.5
ZVR10D681KL738A0	680	420	565	1120	25	2500	1750	11±1	6.8	8	0.65	3.5±0.5
ZVR10D681KL837A0	680	420	565	1120	25	2500	1750	11±1	6.8	7.5	0.78	3.5±0.5
ZVR10D681KL8C7A0	680	420	565	1120	25	2500	1750	11±1	6.8	7.5	0.78	3.2±0.3
ZVR10D821KL837A0	820	510	670	1355	25	2500	1750	11±1	7.5	7.5	0.78	3.5±0.5
ZVR14D151KL8B7A0	150	95	125	250	50	4500	2500	15±1.5	4.5	7.5	0.78	25min
ZVR14D241KL8B7A0	240	150	200	395	50	4500	2500	15±1.5	4.8	7.5	0.78	25min

ZVR14D271KL877A0	270	175	225	455	50	4500	2500	15±1.5	5.1	7.5	0.78	7.0±0.5
ZVR14D471KK837A1	470	300	385	775	50	4500	2500	15±1.5	6.0	7.5	0.78	3.5±0.5
ZVR14D471KK8C7A0J	470	300	385	775	50	6000	4500	15±1.5	6.0	7.5	0.78	3.2±0.3
ZVR14D471KK8C7G1	470	300	385	775	50	4500	2500	15±1.5	6.0	7.5	0.78	3.2±0.3
ZVR14D471KL807A0	470	300	385	775	50	4500	2500	15±1.5	6.0	7.5	0.78	10.0±1.0
ZVR14D471KL837A0	470	300	385	775	50	4500	2500	15±1.5	6.0	7.5	0.78	3.5±0.5
ZVR14D471KL847A0	470	300	385	775	50	4500	2500	15±1.5	6.0	7.5	0.78	4.0±0.5
ZVR14D471KL857A0	470	300	385	775	50	4500	2500	15±1.5	6.0	7.5	0.78	5.0±0.5
ZVR14D471KL877A0	470	300	385	775	50	4500	2500	15±1.5	6.0	7.5	0.78	7.0±0.5
ZVR14D471KL8C7A0J	470	300	385	775	50	6000	4500	15±1.5	6.0	7.5	0.78	3.2±0.3
ZVR14D511KL837A0	510	320	430	840	50	4500	2500	15±1.5	6.2	7.5	0.78	3.5±0.5
ZVR14D511KL847A0	510	320	430	840	50	4500	2500	15±1.5	6.2	7.5	0.78	4.0±0.5
ZVR14D511KL8B7A0	510	320	430	840	50	4500	2500	15±1.5	6.2	7.5	0.78	25min
ZVR14D561KK837E0	560	356	468	925	50	4500	2500	15±1.5	6.4	7.5	0.78	3.5±0.5
ZVR14D561KK837F1	560	356	468	925	50	4500	2500	15±1.5	6.4	7.5	0.78	3.5±0.5
ZVR14D561KK8C7A0J	560	356	468	925	50	6000	4500	15±1.5	6.4	7.5	0.78	3.2±0.3
ZVR14D561KL837A0	560	356	468	925	50	4500	2500	15±1.5	6.4	7.5	0.78	3.5±0.5
ZVR14D561KL837A0J	560	356	468	925	50	6000	4500	15±1.5	6.4	7.5	0.78	3.5±0.5
ZVR14D561KL837E0	560	356	468	925	50	4500	2500	15±1.5	6.4	7.5	0.78	3.5±0.5
ZVR14D561KL887A0	560	356	468	925	50	4500	2500	15±1.5	6.4	7.5	0.78	8.0±1.0
ZVR14D561KL8C7A0J	560	356	468	925	50	6000	4500	15±1.5	6.4	7.5	0.78	3.2±0.3
ZVR14D621KB837FB	620	385	505	1025	50	4500	2500	15±1.5	6.6	7.5	0.78	3.5±0.5
ZVR14D621KB837GB	620	385	505	1025	50	4500	2500	15±1.5	6.6	7.5	0.78	3.5±0.5
ZVR14D621KK7Y7F1	620	385	505	1025	50	4500	2500	15±1.5	6.6	7.5	0.65	Y型编带
ZVR14D621KK837FB	620	385	505	1025	50	4500	2500	15±1.5	6.6	7.5	0.78	3.5±0.5
ZVR14D621KK837GB	620	385	505	1025	50	4500	2500	15±1.5	6.6	7.5	0.78	3.5±0.5
ZVR14D621KK8C8FB	620	385	505	1025	50	4500	2500	15±1.5	6.6	8	0.78	3.2±0.3
ZVR14D681KB837A0J	680	420	565	1120	50	6000	4500	15±1.5	6.8	7.5	0.78	3.5±0.5
ZVR14D681KK837A0	680	420	565	1120	50	4500	2500	15±1.5	6.8	7.5	0.78	3.5±0.5
ZVR14D681KK837E0	680	420	565	1120	50	4500	2500	15±1.5	6.8	7.5	0.78	3.5±0.5
ZVR14D681KK837G1	680	420	565	1120	50	4500	2500	15±1.5	6.8	7.5	0.78	3.5±0.5
ZVR14D681KL837A0J	680	420	565	1120	50	6000	4500	15±1.5	6.8	7.5	0.78	3.5±0.5
ZVR14D681KL8J7A0	680	420	565	1120	50	4500	2500	15±1.5	6.8	7.5	0.78	4.5±0.5
ZVR14D681KT837G1	680	420	565	1120	50	4500	2500	15±1.5	6.8	7.5	0.78	3.5±0.5

ZVR14D751KB837F1	750	460	615	1240	50	4500	2500	15±1.5	7.0	7.5	0.78	3.5±0.5
ZVR14D751KF837G1	750	460	615	1240	50	4500	2500	15±1.5	7.0	7.5	0.78	3.5±0.5
ZVR14D751KK837F1	750	460	615	1240	50	4500	2500	15±1.5	7.0	7.5	0.78	3.5±0.5
ZVR14D751KK837G1	750	460	615	1240	50	4500	2500	15±1.5	7.0	7.5	0.78	3.5±0.5
ZVR14D751KK8C7G1	750	460	615	1240	50	4500	2500	15±1.5	7.0	7.5	0.78	3.2±0.3
ZVR14D751KT8C7F1	750	460	615	1240	50	4500	2500	15±1.5	7.0	7.5	0.78	3.2±0.3
ZVR14D751KT8C7G1	750	460	615	1240	50	4500	2500	15±1.5	7.0	7.5	0.78	3.2±0.3
ZVR20D431KK830A0	430	275	350	710	100	6500	4000	21±1.5	6.4	10	0.78	3.5±0.5
ZVR20D751KL8B0A0	750	460	615	1240	100	6500	4000	21±1.5	7.3	10	0.78	25min

## 标志 Marking

例如 e.g

正面 front	背面 back
	

# 编带样式 Taping style

## TAPING STYLE F

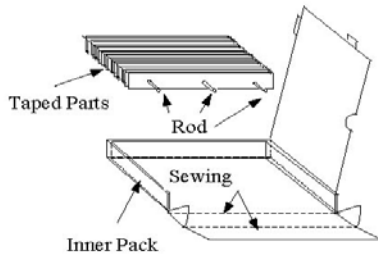
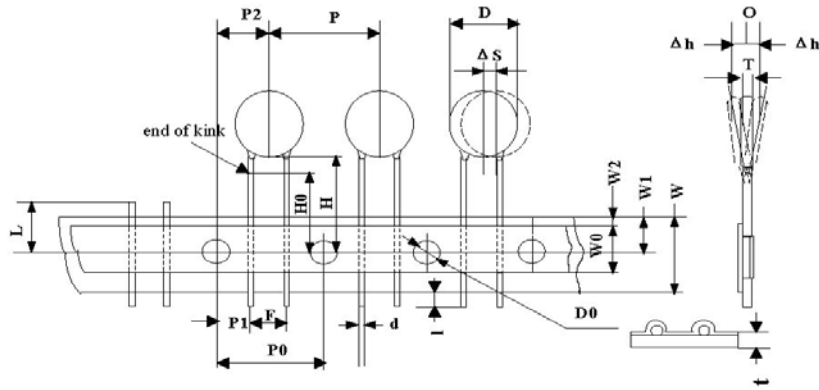

- 1.\* For lead styles of inside kink and outside kink only
2. The lead sharp shall change with lead style.

Symbol	Dimension(mm)
P0	12.7±0.2
P	12.7±1.0
F	5.0±0.5
P1	3.85±0.4
P2	6.35±0.4
H0	16.0±0.5*
H	20.0±0.5
W	18.0±0.5
W0	8.0min.
W1	9.0±0.3
W2	3.0max.
t	0.7±0.2
D	To comply with individual sheet
D0	4±0.2
d	To comply with individual sheet
l	2.0max.
L	11max.
T	To comply with individual sheet
Δ S	0.5max.
Δ h	0.5max.

Figure 2



## TAPING STYLE V

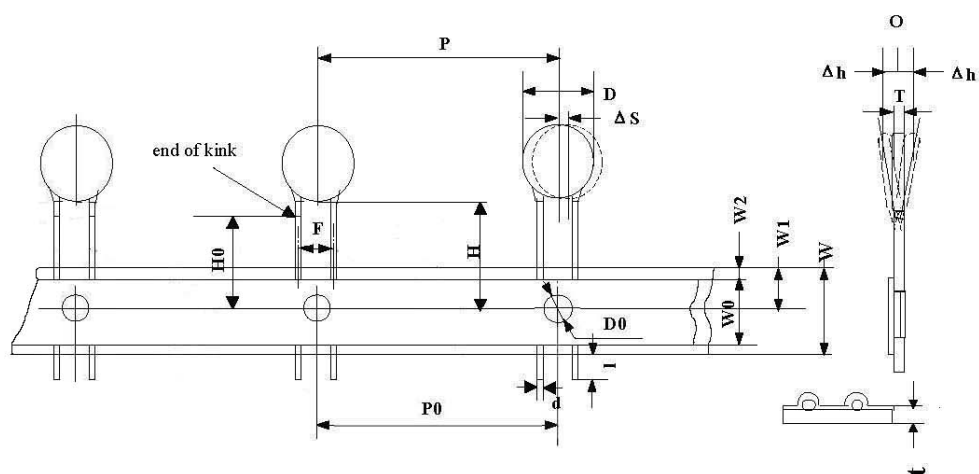

Symbol	Dimension(mm)
<b>P0</b>	<b>15.0±0.2</b>
<b>P</b>	<b>15.0±1.0</b>
<b>F</b>	<b>10.0±0.5</b>
<b>P1</b>	
<b>P2</b>	
<b>H0</b>	<b>16.0±0.5*1</b>
<b>H</b>	<b>20.0±0.5*2</b>
<b>W</b>	<b>18.0±0.5</b>
<b>W0</b>	<b>8.0min.</b>
<b>W1</b>	<b>9.0±0.3</b>
<b>W2</b>	<b>3.0max.</b>
<b>t</b>	<b>0.7±0.2</b>
<b>D</b>	To comply with individual sheet
<b>D0</b>	<b>4±0.2</b>
<b>d</b>	To comply with individual sheet
<b>l</b>	<b>2.0max.</b>
<b>T</b>	To comply with individual sheet
<b>ΔS</b>	<b>1.0 max.</b>
<b>Δh</b>	<b>1.0 max.</b>

1. \*1 打弯脚型以H0为准。

For kink lead only.

2. \*2 直脚产品以H为准。

For straight lead only.

**Figure 3**



# TAPING STYLE U

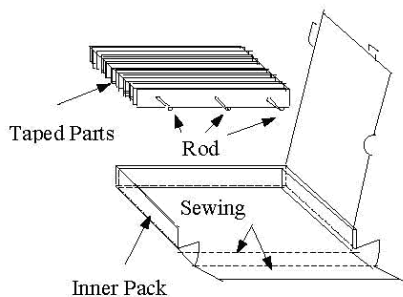
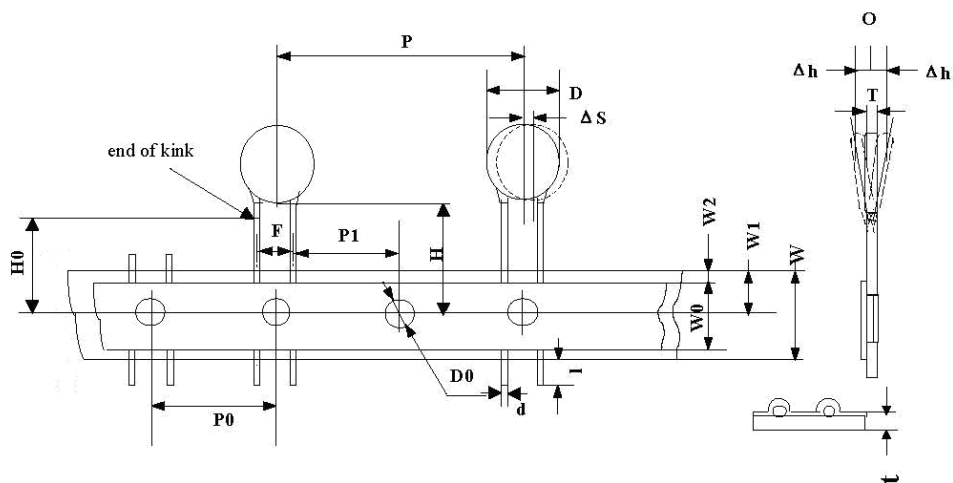

Symbol	Dimension(mm)
P0	12.7±0.2
P	25.4±1.0
F	10.0±0.5
P1	7.7±0.4
P2	
H0	16.0±0.5*1
H	20.0±0.5*2
W	18.0±0.5
W0	8.0min.
W1	9.0±0.3
W2	3.0max.
t	0.7±0.2
D	To comply with individual sheet
D0	4±0.2
d	To comply with individual sheet
l	2.0max.
T	To comply with individual sheet
ΔS	1.0 max.
Δh	1.0 max.

1. \*1 打弯脚型以H0为准。

For kink lead only.

2. \*2 直脚产品以H为准。

For straight lead only.

Figure 6

## X-ON Electronics

Largest Supplier of Electrical and Electronic Components

*Click to view similar products for [Varistors](#) category:*

*Click to view products by [South HongMing](#) manufacturer:*

Other Similar products are found below :

[R71ZOV151HC](#) [B72205S271K111](#) [B72214S251K151](#) [NTE1V020](#) [NTE1V130](#) [25FN511K](#) [S10K11G5S5](#) [ERZ-C14DK361U](#) [ERZ-C20DK221U](#) [207869-1](#) [AS-13](#) [B72540E 350K 62](#) [B72590D360A60](#) [B72650M301K93](#) [B72670M1140K72](#) [TVZ18EC271KBS](#) [TVZ20EB911KBS](#) [TVZ25D201KBS](#) [TVZ25D241KBS](#) [VDRH20X230BSE](#) [VZ07D220KBS](#) [VZ40D241KQ-N](#) [VZ40D241K](#) [VZ25D511KBS-N](#) [VZ20E511KBSX](#) [VZ20E221KBSX](#) [VZ10D471KBS-N](#) [20A9FN241K](#) [B72650M350K72](#) [TVZ25D301KBS](#) [TVZ20EC911KBS](#) [TVZ20EBN911KBS](#) [TVZ18EC471KBS](#) [B72220S350K101](#) [NTE1V030](#) [NTE1V275](#) [NTE2V015](#) [NTE2V035](#) [NTE2V115](#) [VZ20D391KBS-N](#) [VZ10D241KBS-N](#) [VZ07D390KBS-N](#) [VDRH14V060TSE](#) [VDRH20X300BKE](#) [V300LT4PX1841](#) [NTE1V017](#) [NTE1V115](#) [NTE1V150](#) [NTE1V300](#) [NTE2V025](#)