

Product Specification

Part Name : OEL Display Module
Customer Part ID :
WiseChip Part ID : UG-6032CSWBGA1
Doc No. : SAS1-12003-B

Customer:

Approved by

CONFIDENTIAL

From: WiseChip Semiconductor Inc.

Approved by

WiseChip Semiconductor Inc.

8, Kebei RD 2, Science Park, Chu-Nan, Taiwan 350, R.O.C.

Notes:

1. Please contact WiseChip Semiconductor Inc. before assigning your product based on this module specification
2. The information contained herein is presented merely to indicate the characteristics and performance of our products. No responsibility is assumed by WiseChip Semiconductor Inc. for any intellectual property claims or other problems that may result from application based on the module described herein.



Revised History

Project Number	Revision	Revision Content	Revised on
UG-6032CSWBGA1	A	New	May 16, 2017
UG-6032CSWBGA1	B	Page 1 Section 1.2 - Correct Module size - Correct Panel size	June 8, 2017
CONFIDENTIAL			



Contents

Revision History.....i
Contents.....ii
1. Basic Specifications..... 1~3
1.1 Display Specifications 1
1.2 Mechanical Specifications..... 1
1.3 Active Area / Memory Mapping & Pixel Construction 1
1.4 Mechanical Drawing..... 2
1.5 Pin Definition 3
2. Absolute Maximum Ratings 4
3. Optics & Electrical Characteristics 5~8
3.1 Optics Characteristics 5
3.2 DC Characteristics 5
3.3 AC Characteristics 6
3.3.1 Serial Interface Timing Characteristics (4-wire SPI) 6
3.3.2 Serial Interface Timing Characteristics (3-wire SPI) 7
3.3.3 I2C Interface Timing Characteristics..... 8
4. Functional Specification..... 9~13
4.1 Commands 9
4.2 Power down and Power up Sequence 9
4.2.1 Power up Sequence 9
4.2.2 Power down Sequence 9
4.3 Reset Circuit 9
4.4 Application Circuit 10
4.4.1 4-wire Serial Interface 10
4.4.2 3-wire Serial Interface 11
4.4.3 I2C Interface 12
4.5 Actual Application Example 13
5. Reliability 15
5.1 Contents of Reliability Tests 15
5.2 Failure Check Standard 16
6. Outgoing Quality Control Specifications..... 17~20
6.1 Environment Required 17
6.2 Sampling Plan 17
6.3 Criteria & Acceptable Quality Level 17
6.3.1 Cosmetic Check (Display Off) in Non-Active Area..... 17
6.3.2 Cosmetic Check (Display Off) in Active Area..... 19
6.3.3 Pattern Check (Display On) in Active Area..... 20
7. Package Specifications..... 21
8. Precautions When Using These OEL Display Modules 22~23
8.1 Handling Precautions 22
8.2 Storage Precautions..... 22
8.3 Designing Precautions 23
8.4 Precautions when disposing of the OEL display modules 23
8.5 Other Precautions..... 23
Warranty..... 24
Notice..... 24

CONFIDENTIAL

1. Basic Specifications

1.1 Display Specifications

- 1) Display Mode : Passive Matrix
- 2) Display Color : Monochrome (White)
- 3) Drive Duty : 1/32 Duty

1.2 Mechanical Specifications

- 1) Outline Drawing : According to the annexed outline drawing
- 2) Number of Pixels : 160 × 32
- 3) Module Size : 113.30 × 14.94 × 0.3 (mm)
- 4) Panel Size : 55.30 × 14.94 × 0.3 (mm)
- 5) Active Area : 45.096 × 9.00 (mm)
- 6) Pixel Pitch : 0.282 × 0.282 (mm)
- 7) Pixel Size : 0.258 × 0.258 (mm)
- 8) Weight : TBD (g) ± 10%

1.3 Active Area / Memory Mapping & Pixel Construction

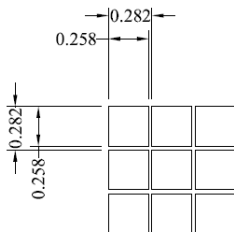
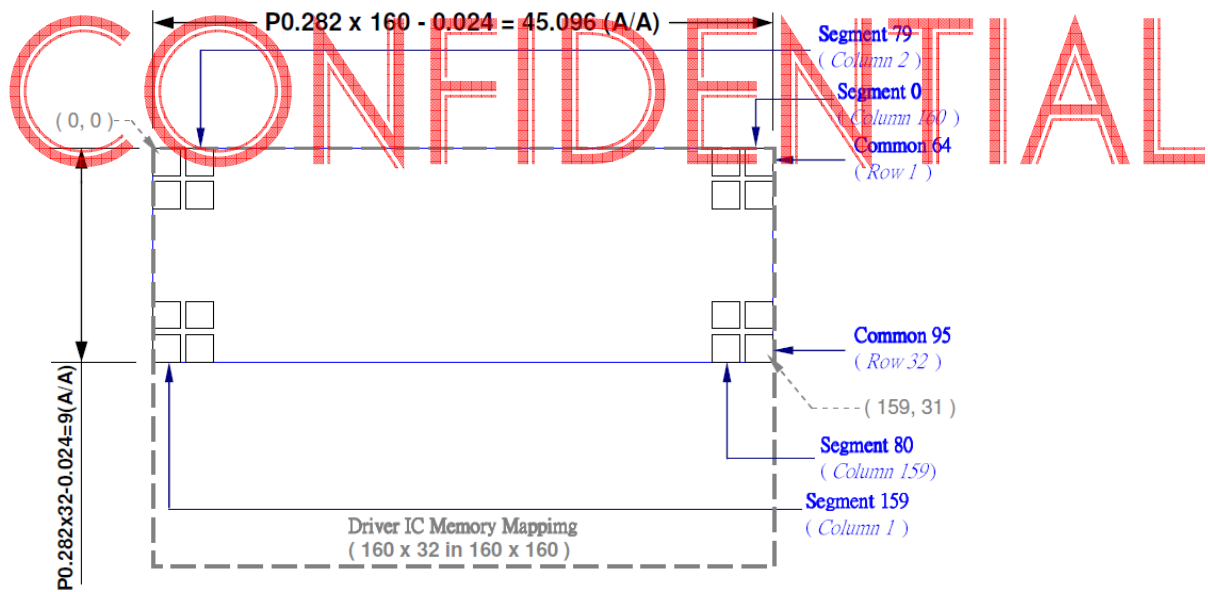

Detail Pixel
Scale (10:1)

1.4 Mechanical Drawing

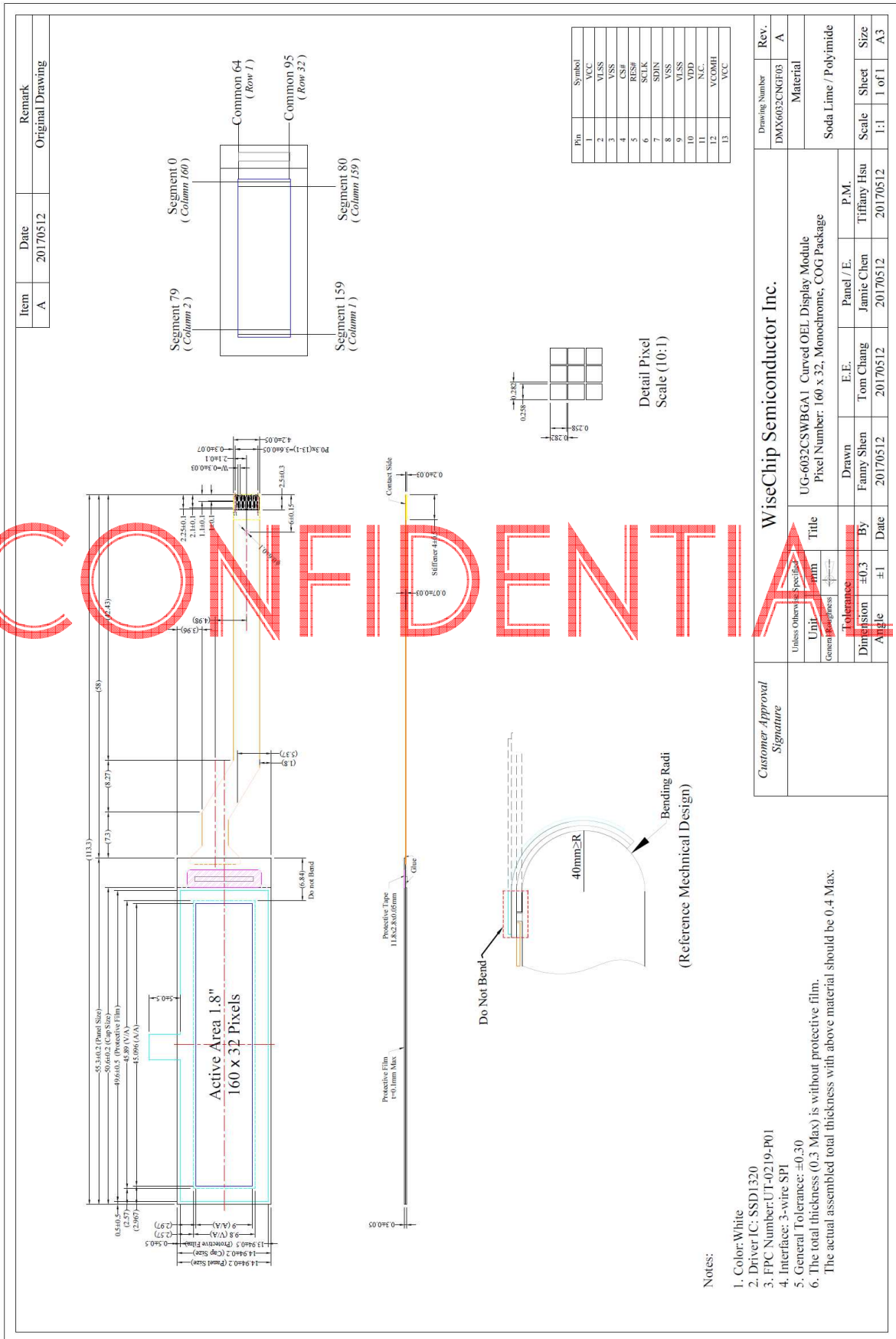

The drawing contained herein is the exclusive property of WiseChip. It is not allowed to copy, reproduce and/or disclose in any form without permission of WiseChip.

1.5 Pin Definition

Pin Number	Symbol	I/O	Function
Power Supply			
1, 13	VCC	P	Power Supply for OEL Panel This is the most positive voltage supply pin of the chip. It must be supplied externally.
2, 9	VLSS	P	Ground of Analog Circuit This is an analog ground pin. It should be connected to V_{SS} externally.
3, 8	VSS	P	Ground of Logic Circuit This is a ground pin. It acts as a reference for the logic pins. It must be connected to external ground.
10	VDD	P	Power Supply for Logic This is a voltage supply pin. It must be connected to external source.
Driver			
12	VCOMH	O	Voltage Output High Level for COM Signal This pin is the input pin for the voltage output high level for COM signals. A capacitor should be connected between this pin and V_{SS} .
Interface			
4	CS#	I	Chip Select This pin is the chip select input. The chip is enabled for MCU communication only when CS# is pulled low.
5	RES#	I	Power Reset for Controller and Driver This pin is reset signal input. When the pin is low, initialization of the chip is executed. Keep this pin pull high during normal operation.
6	SCLK	I	Serial Clock Input Signal The transmission of information in the bus is following a clock signal. Each transmission of data bit is taken place during a single clock period of this pin.
7	SDIN	I	Serial Data Input Signal This pin acts as a communication channel. The input data through SDIN are latched at the rising edge of SCLK in the sequence of MSB first and converted to 8-bit parallel data and handled at the rising edge of last serial clock. SDIN is identified to display data or command by D/C# bit data at the rising of first SCLK.
Reserve			
11	N.C.	-	Reserved Pin The N.C. pin between function pins are reserved for compatible and flexible design.



2. Absolute Maximum Ratings

Parameter	Symbol	Min	Max	Unit	Notes
Supply Voltage for Logic	V _{DD}	-0.3	4	V	1, 2
Supply Voltage for Display	V _{CC}	0	14	V	1, 2
Operating Temperature	T _{OP}	-40	60	°C	
Storage Temperature	T _{STG}	-40	75	°C	3
Life Time (600 cd/m ²)		3,000	-	hour	4

Note 1: All the above voltages are on the basis of "V_{SS} = 0V".

Note 2: When this module is used beyond the above absolute maximum ratings, permanent breakage of the module may occur. Also, for normal operations, it is desirable to use this module under the conditions according to Section 3. "Optics & Electrical Characteristics". If this module is used beyond these conditions, malfunctioning of the module can occur and the reliability of the module may deteriorate.

Note 3: V_{CC} = 12.0V, T_a = 25°C, 50% Checkerboard.

Software configuration follows Section 4.5 Initialization.

End of lifetime is specified as 50% of initial brightness reached. The average operating lifetime at room temperature is estimated by the accelerated operation at high temperature conditions.

CONFIDENTIAL

3. Optics & Electrical Characteristics

3.1 Optics Characteristics

Characteristics	Symbol	Conditions	Min	Typ	Max	Unit
Brightness	L_{br}	Note 7	420	600	-	cd/m ²
C.I.E. (White)	(x)	C.I.E. 1931	0.25	0.29	0.33	
	(y)		0.29	0.33	0.37	
Dark Room Contrast	CR		-	>10,000:1	-	
Viewing Angle			-	Free	-	degree

* Optical measurement taken at $V_{DD} = 3.0V$, $V_{CC} = 12.0V$.
Software configuration follows Section 4.5 Initialization.

3.2 DC Characteristics

Characteristics	Symbol	Conditions	Min	Typ	Max	Unit
Supply Voltage for Logic	V_{DD}		1.65	2.8	3.5	V
Supply Voltage for Display	V_{CC}	Note 4	11.5	12.0	12.5	V
High Level Input	V_{IH}		$0.8 \times V_{DD}$	-	V_{DD}	V
Low Level Input	V_{IL}		0	-	$0.2 \times V_{DD}$	V
High Level Output	V_{OH}	$I_{OUT} = 100\mu A, 10MHz$	$0.9 \times V_{DD}$	-	V_{DD}	V
Low Level Output	V_{OL}	$I_{OUT} = 100\mu A, 10MHz$	0	-	$0.1 \times V_{DD}$	V
Operating Current for V_{DD}	I_{DD}		-	350	700	μA
Operating Current for V_{CC}	I_{CC}	Note 5	-	13.3	16.6	mA
		Note 6	-	20.5	25.6	mA
		Note 7	-	36.7	45.9	mA
Sleep Mode Current for V_{DD}	$I_{DD, SLEEP}$		-	-	10	μA
Sleep Mode Current for V_{CC}	$I_{CC, SLEEP}$		-	-	10	μA

Note 4: Brightness (L_{br}) and Supply Voltage for Display (V_{CC}) are subject to the change of the panel characteristics and the customer's request.

Note 5: $V_{DD} = 3.0V$, $V_{CC} = 12.0V$, 30% Display Area Turn on.

Note 6: $V_{DD} = 3.0V$, $V_{CC} = 12.0V$, 50% Display Area Turn on.

Note 7: $V_{DD} = 3.0V$, $V_{CC} = 12.0V$, 100% Display Area Turn on.

* Software configuration follows Section 4.5 Initialization.

3.3 AC Characteristics

Serial Interface Timing Characteristics: (3-wire SPI)

Symbol	Description	Min	Max	Unit
t_{cycle}	Clock Cycle Time	66	-	ns
t_{CSS}	Chip Select Setup Time	20	-	ns
t_{CSH}	Chip Select Hold Time	10	-	ns
t_{DSW}	Write Data Setup Time	15	-	ns
t_{DHW}	Write Data Hold Time	15	-	ns
t_{CLKL}	Clock Low Time	20	-	ns
t_{CLKH}	Clock High Time	20	-	ns
t_R	Rise Time	-	15	ns
t_F	Fall Time	-	15	ns

* ($V_{DD} - V_{SS} = 1.65V$ to $3.5V$, $T_a = 25^\circ C$)

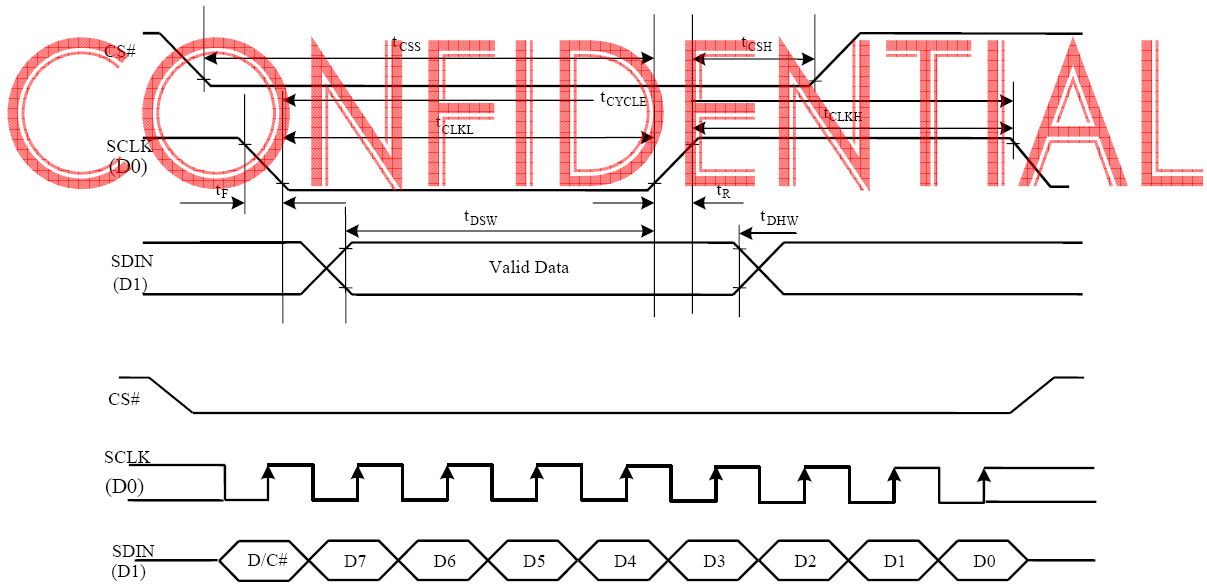

4. Functional Specification

4.1 Commands

Refer to the Technical Manual for the SSD1320

4.2 Power down and Power up Sequence

To protect OEL panel and extend the panel life time, the driver IC power up/down routine should include a delay period between high voltage and low voltage power sources during turn on/off. It gives the OEL panel enough time to complete the action of charge and discharge before/after the operation.

4.2.1 Power up Sequence:

1. Power up V_{DD}
2. Send Display off command
3. Initialization
4. Clear Screen
5. Power up V_{CC}
6. Delay 100ms
(When V_{CC} is stable)
7. Send Display on command

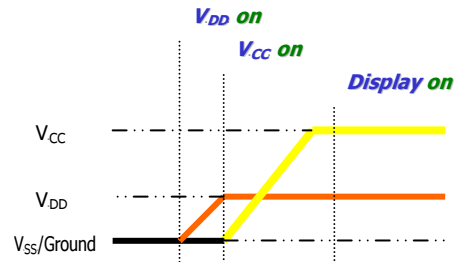

4.2.2 Power down Sequence:

1. Send Display off command
2. Power down V_{CC}
3. Delay 100ms
(When V_{CC} is reach 0 and panel is completely discharges)
4. Power down V_{DD}

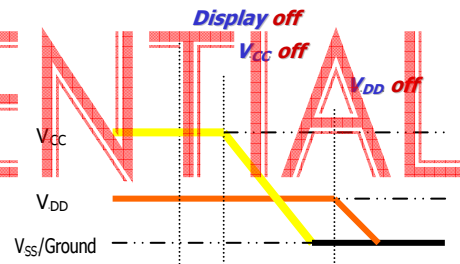

Note 8:

- 1) Since an ESD protection circuit is connected between V_{DD} and V_{CC} inside the driver IC, V_{CC} becomes lower than V_{DD} whenever V_{DD} is ON and V_{CC} is OFF.
- 2) V_{CC} should be kept float (disable) when it is OFF.
- 3) Power Pins (V_{DD} , V_{CC}) can never be pulled to ground under any circumstance.
- 4) V_{DD} should not be power down before V_{CC} power down.

4.3 Reset Circuit

When RES# input is low, the chip is initialized with the following status:

1. Display is OFF
2. 160x160 Display Mode
3. Normal segment and display data column and row address mapping (SEG0 mapped to column address 00h and COM0 mapped to row address 00h)
4. Shift register data clear in serial interface
5. Display start line is set at display RAM address 0
6. Column address counter is set at 0
7. Normal scan direction of the COM outputs
8. Contrast control register is set at 7Fh
9. Normal display mode (Equivalent to A4h command)

4.4 Application Circuit

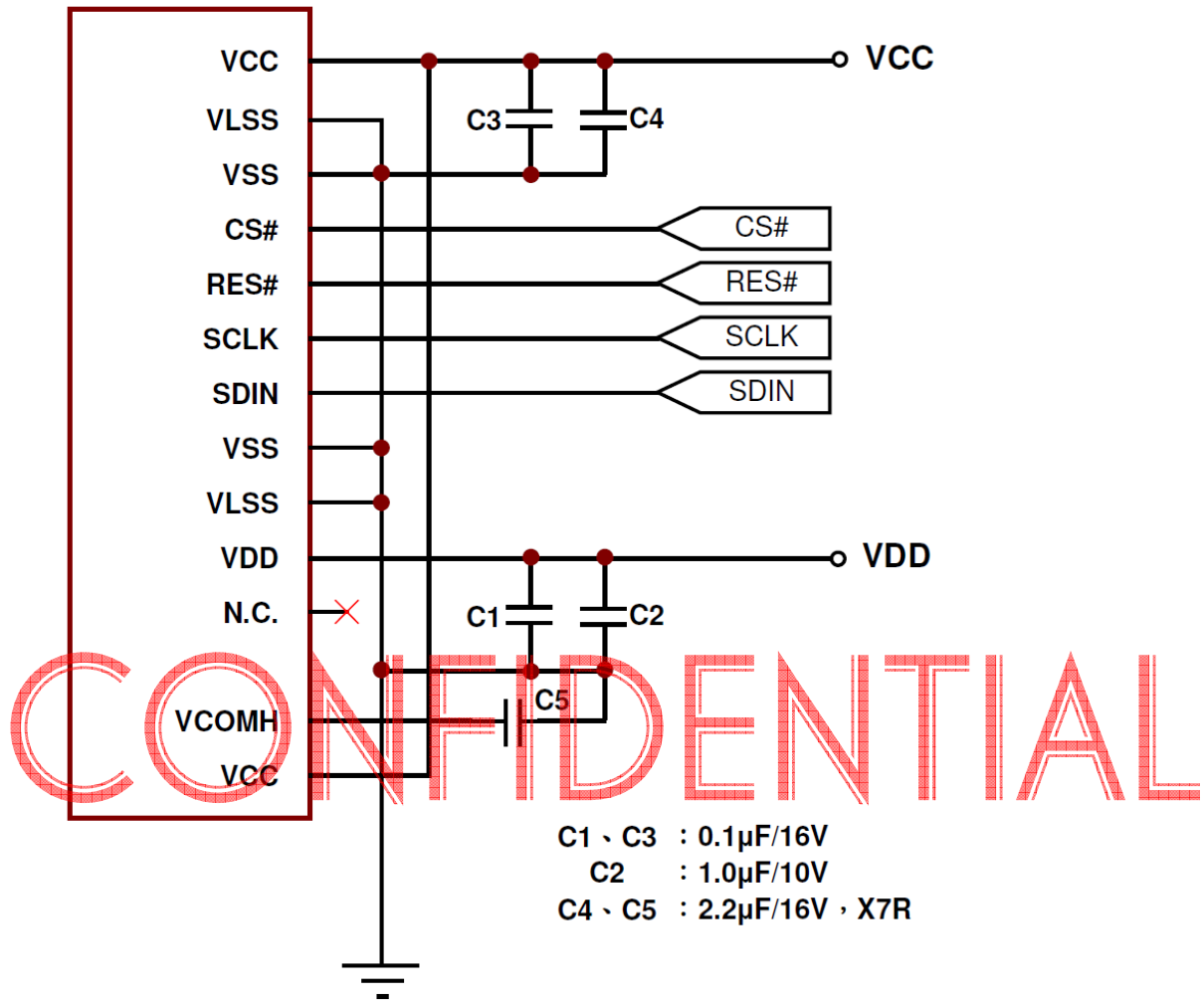

4.5 Actual Application Example

Command usage and explanation of an actual example

<Power up Sequence>

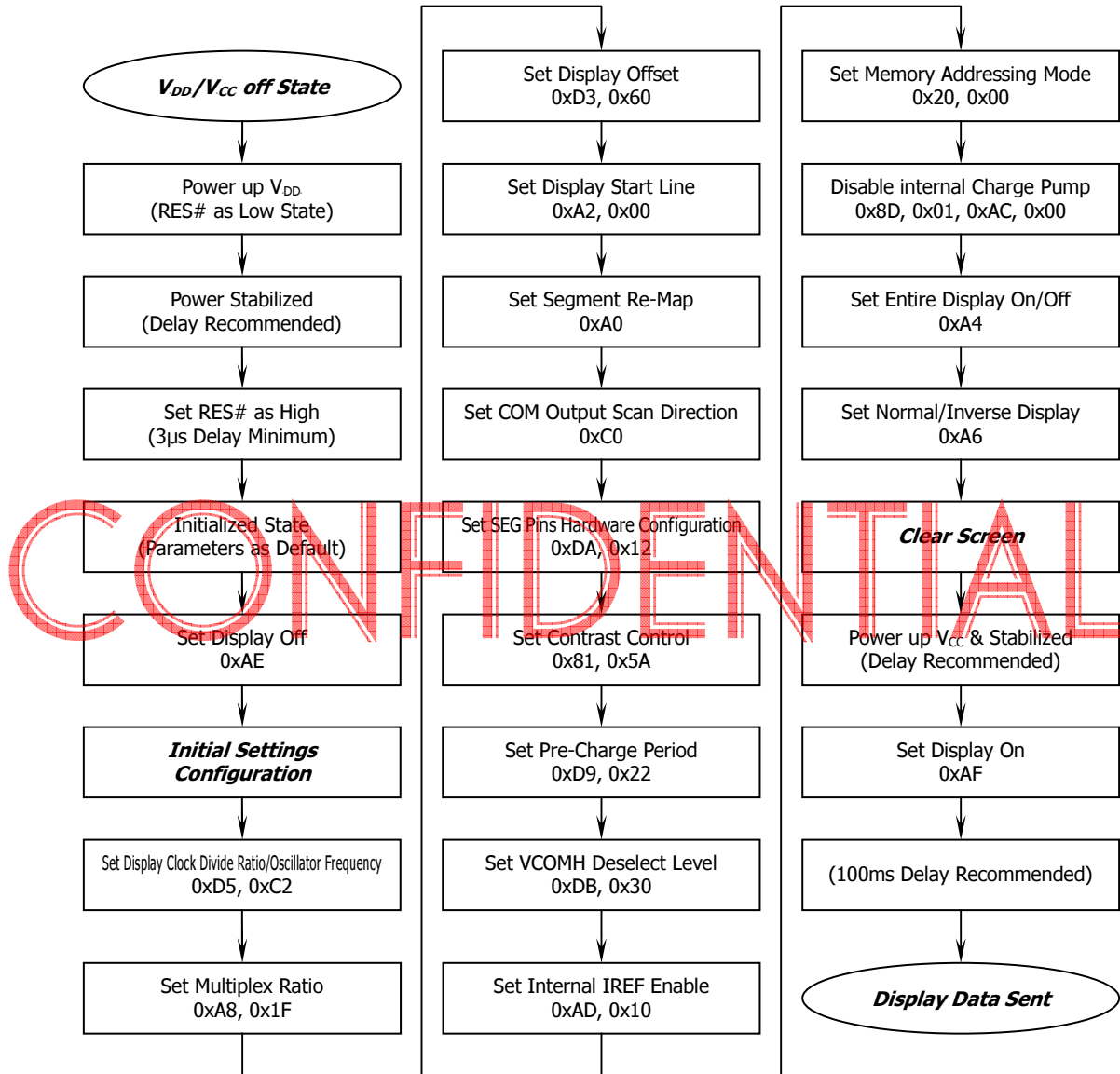

If the noise is accidentally occurred at the displaying window during the operation, please reset the display in order to recover the display function.

<Power down Sequence>

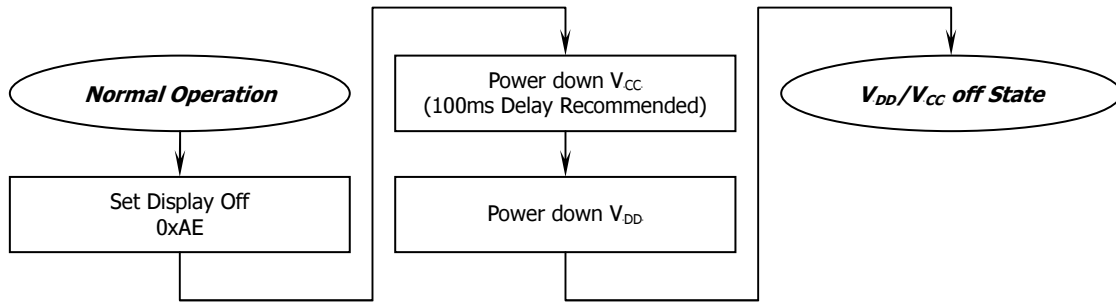

<Entering Sleep Mode>

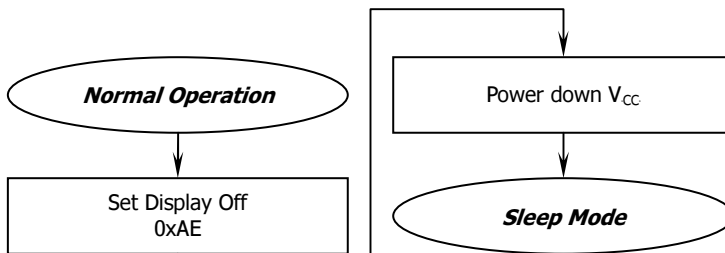

<Exiting Sleep Mode>

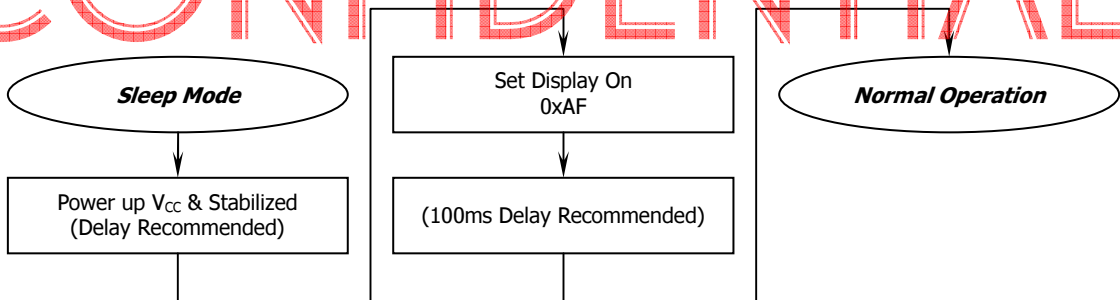

CONFIDENTIAL

5. Reliability

5.1 Contents of Reliability Tests

Item	Conditions	Criteria
High Temperature Operation	60°C, 96 hrs	The operational functions work.
Low Temperature Operation	-40°C, 96 hrs	
High Temperature Storage	75°C, 96 hrs	
Low Temperature Storage	-40°C, 96 hrs	
High Temperature/Humidity Operation	60°C, 90% RH, 96 hrs	
Thermal Shock	-40°C ↔ 75°C, 10 cycles 60 minutes dwell	
Bending Test	R40mm bending test, 10 times (Note 9)	

* No moisture condensation is observed during tests.

Note 9: Method of bend test

One end of an OLED panel is fixed on a cylinder of 40mm radius with the sealing film side down like the schematic diagram below.

After 10 times bending, whether abnormalities of display appears or not is checked by lighting inspection.

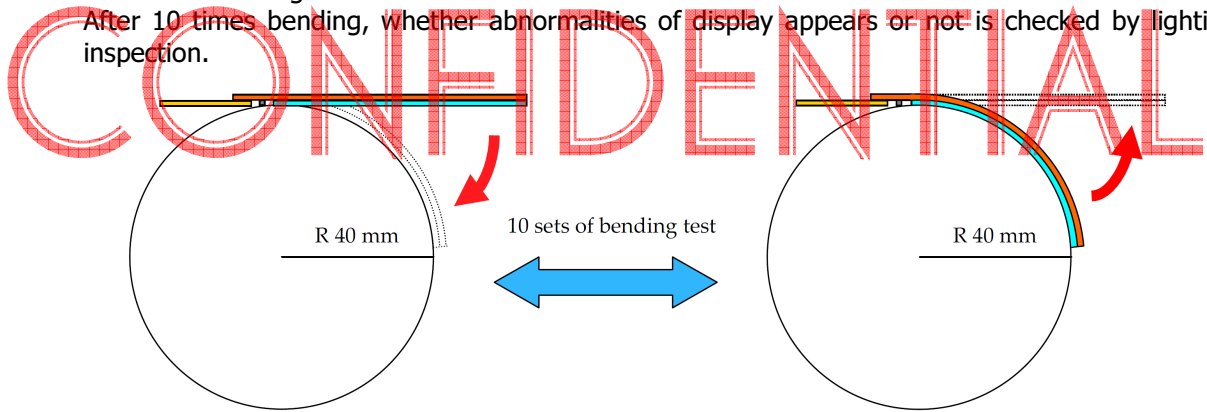

Bend characteristics

1. Bend area

- Display surface
- Viewing area
- Sealing film area

2. forbidden bend area

- IC assemble area
- No sealing film area

3. Bend direction

- Longer panel side enable
- Shorter panel side unable

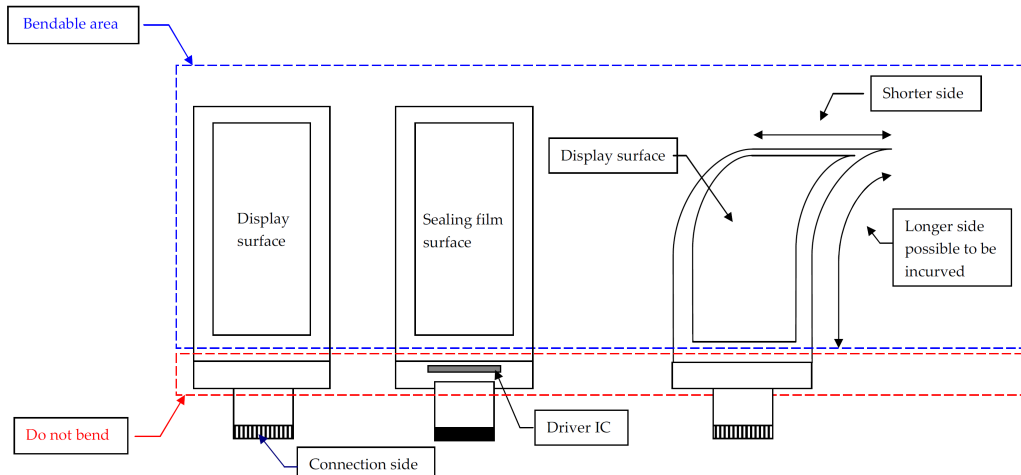



5.2 Failure Check Standard

After the completion of the described reliability test, the samples were left at room temperature for 2 hrs prior to conducting the failure test at $23\pm 5^{\circ}\text{C}$; $55\pm 15\%$ RH.

CONFIDENTIAL

6. Outgoing Quality Control Specifications

6.1 Environment Required

Customer’s test & measurement are required to be conducted under the following conditions:

- Temperature: 23 ± 5°C
- Humidity: 55 ± 15% RH
- Fluorescent Lamp: 30W
- Distance between the Panel & Lamp: ≥ 50cm
- Distance between the Panel & Eyes of the Inspector: ≥ 30cm
- Finger glove (or finger cover) must be worn by the inspector.
- Inspection table or jig must be anti-electrostatic.



6.2 Sampling Plan

Level II, Normal Inspection, Single Sampling, MIL-STD-105E

6.3 Criteria & Acceptable Quality Level

Partition	AQL	Definition
Major	0.65	Defects in Pattern Check (Display On)
Minor	1.0	Defects in Cosmetic Check (Display Off)

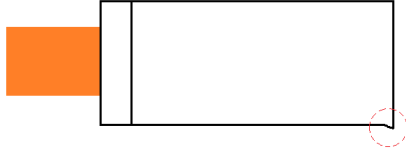
6.3.1 Cosmetic Check (Display Off) in Non-Active Area

Check Item	Classification	Criteria
Display Panel Burr	Minor	 <p>Within dimension tolerance, Ignore for Any. Out of dimension tolerance, Not Allowable.</p>
Copper Exposed (Even Pin or Film)	Minor	Not Allowable by Naked Eye Inspection
Film or Trace Damage	Minor	

6.3.1 Cosmetic Check (Display Off) in Non-Active Area (Continued)

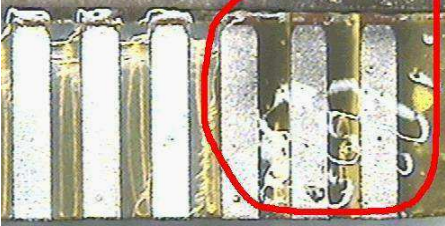
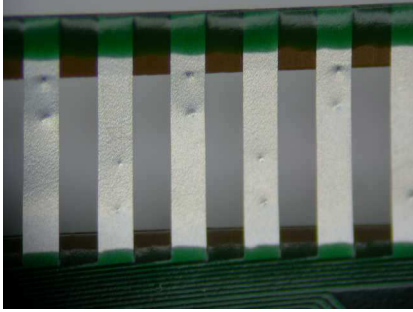
Check Item	Classification	Criteria
Glue or Contamination on Pin (Couldn't Be Removed by Alcohol)	Minor	
Probe Mark on Terminal Lead	Acceptable	
Ink Marking on Back Side of panel (Exclude on Film)	Acceptable	Ignore for Any

CONFIDENTIAL

6.3.2 Cosmetic Check (Display Off) in Active Area

It is recommended to execute in clear room environment (class 10k) if actual in necessary.

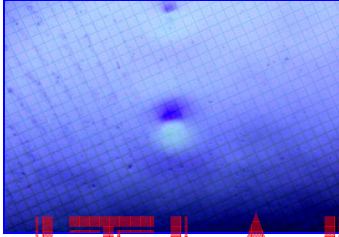
Check Item	Classification	Criteria
Any Dirt & Scratch on Protective Film	Acceptable	Ignore for not Affect the Panel
Scratches, Fiber, Line-Shape Defect (On Display)	Minor	$W \leq 0.1$ Ignore $W > 0.1$ $L \leq 2$ $n \leq 1$ $L > 2$ $n = 0$
Dirt, Black Spot, Foreign Material, (On Display)	Minor	$\Phi \leq 0.1$ Ignore $0.1 < \Phi \leq 0.25$ $n \leq 1$ $0.25 < \Phi$ $n = 0$
Dent, Bubbles, White spot (Any Transparent Spot on Display)	Minor	$\Phi \leq 0.5$ → Ignore if no Influence on Display $0.5 < \Phi$ $n = 0$ 
Fingerprint, Flow Mark (On Panel)	Minor	Not Allowable

CONFIDENTIAL

* Protective film should not be tear off when cosmetic check.

** Definition of W & L & Φ (Unit: mm): $\Phi = (a + b) / 2$

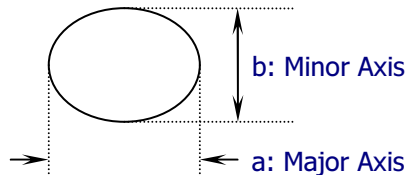
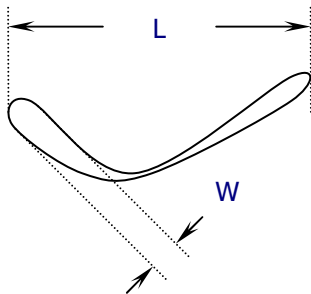

6.3.3 Pattern Check (Display On) in Active Area

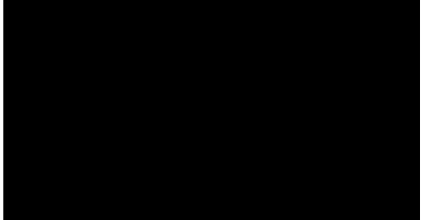
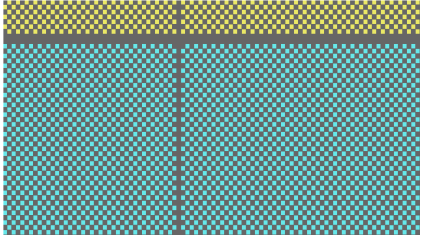
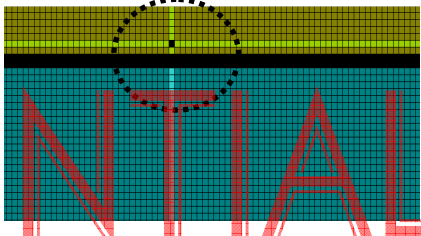
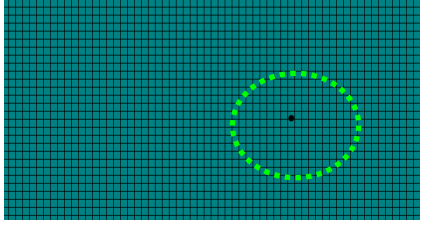
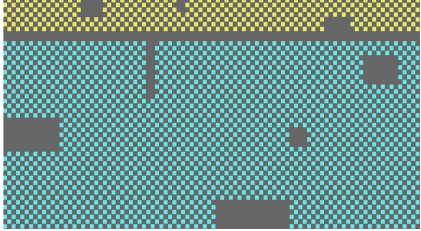
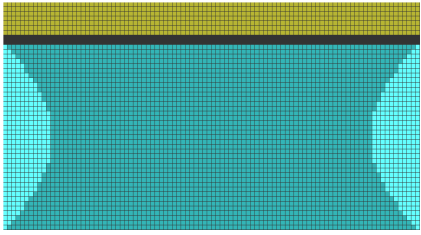
Check Item	Classification	Criteria
No Display	Major	
Missing Line	Major	
Pixel Short	Major	
Darker Pixel	Major	
Wrong Display	Major	
Un-uniform	Major	

CONFIDENTIAL

7. Package Specifications

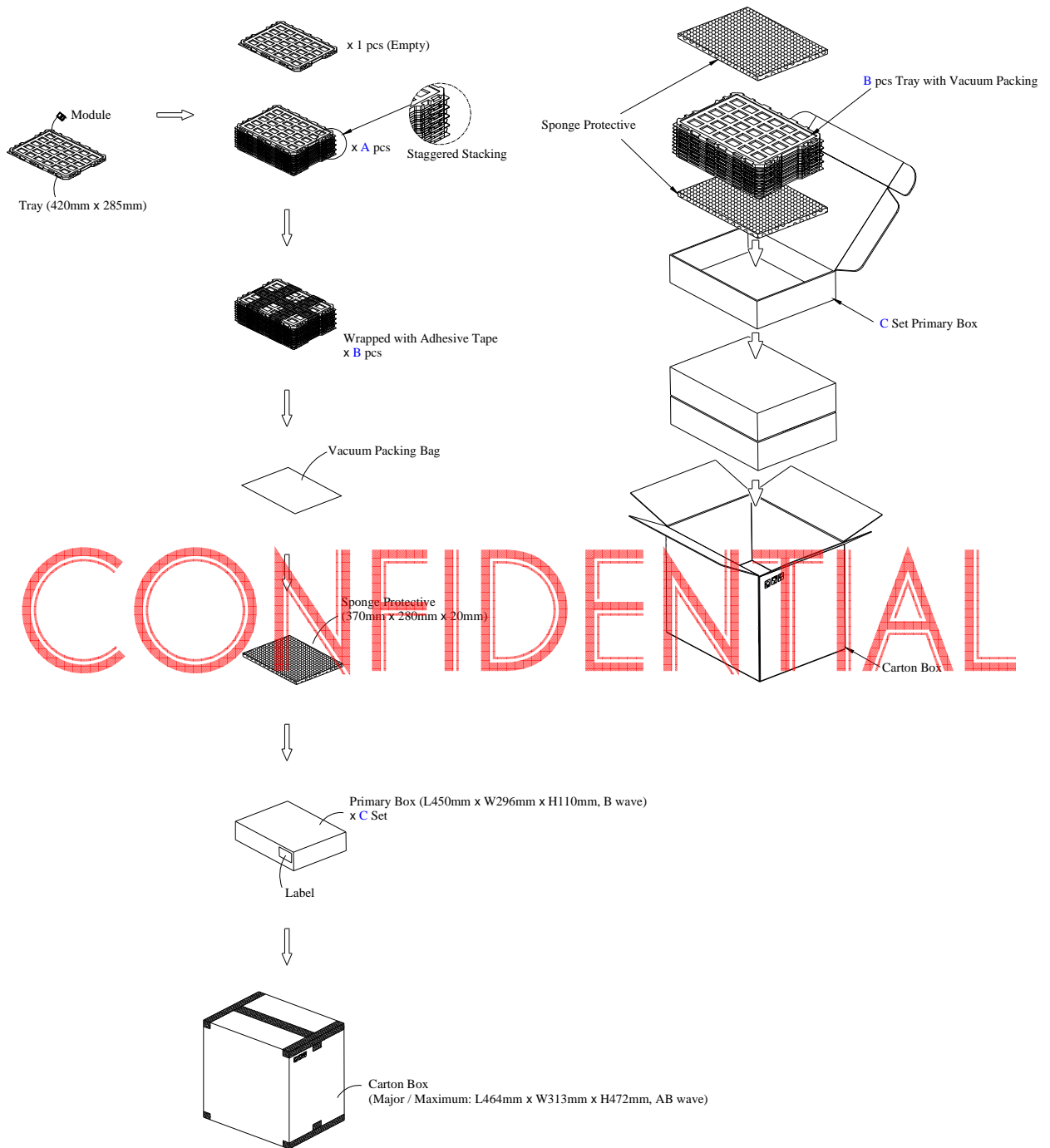

CONFIDENTIAL

Item	Quantity	
Module	TBD	per Primary Box
Holding Trays (A)	TBD	per Primary Box
Total Trays (B)	TBD	per Primary Box (Including 1 Empty Tray)
Primary Box (C)	1~4	per Carton (4 as Major / Maximum)

8. Precautions When Using These OEL Display Modules

8.1 Handling Precautions

- 1) Even the display is being made of plastic, do not apply mechanical impacts such as dropping or striking the module.
- 2) If the display is broken by some accident and the internal organic substance leaks out, be careful not to inhale nor lick the organic substance.
- 3) If pressure is applied to the display surface or its neighborhood of the OEL display module, the cell structure may be damaged and be careful not to apply pressure to these sections.
- 4) The substrate of the OEL display module is soft but easily crack. Please be careful when handling the OEL display module.
- 5) When the surface of the substrate of the OEL display module has soil, clean the surface. It takes advantage of by using following adhesion tape.
 - * Scotch Mending Tape No. 810 or an equivalent
 Never try to breathe upon the soiled surface nor wipe the surface using cloth containing solvent such as ethyl alcohol, since the surface of the substrate will become cloudy. Also, pay attention that the following liquid and solvent may spoil the substrate:
 - * Water
 - * Ketone
 - * Aromatic Solvents
- 6) Hold OEL display module very carefully when placing OEL display module into the system housing. Do not apply excessive stress or pressure to OEL display module. And, do not over bend the display and FPC tails with electrode pattern layouts. These stresses will influence the display performance.

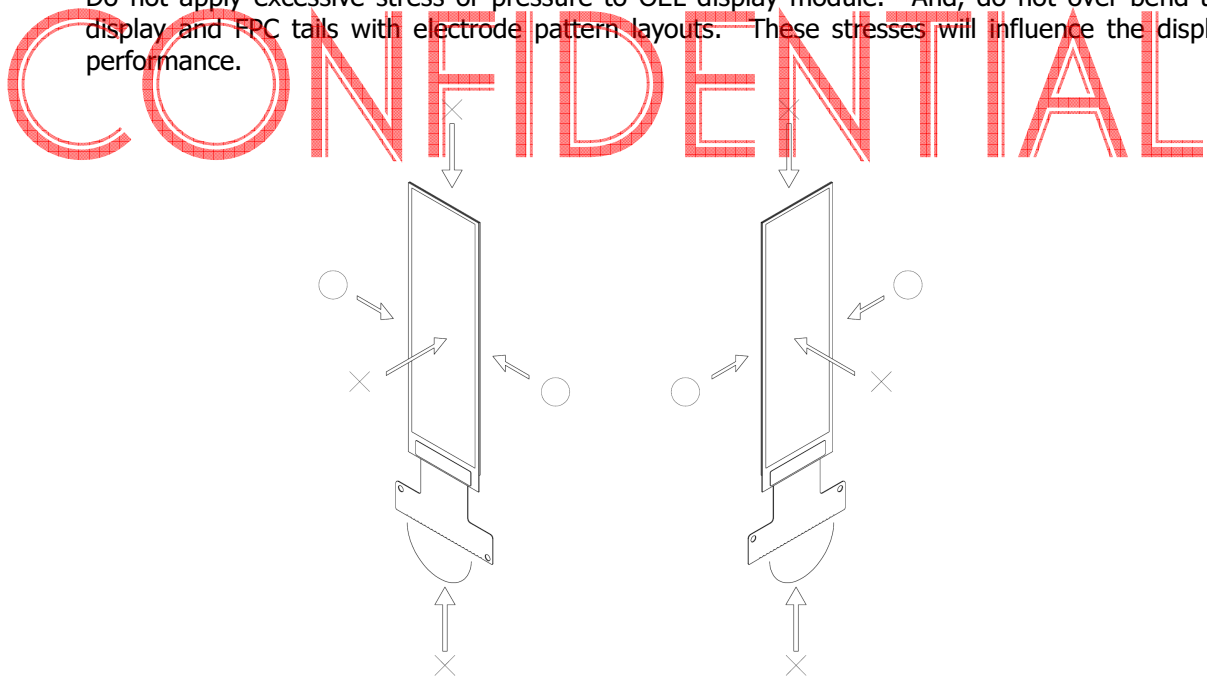

- 7) Do not apply stress to the driver IC and the surrounding molded sections.
- 8) Do not disassemble nor modify the OEL display module.
- 9) Do not apply input signals while the logic power is off.
- 10) Pay sufficient attention to the working environments when handing OEL display modules to prevent occurrence of element breakage accidents by static electricity.
 - * Be sure to make human body grounding when handling OEL display modules.
 - * Be sure to ground tools to use or assembly such as soldering irons.
 - * To suppress generation of static electricity, avoid carrying out assembly work under dry environments.
 - * Protective film is being applied to the surface of the display panel of the OEL display module. Be careful since static electricity may be generated when exfoliating the protective film.
- 11) Protection film is being applied to the surface of the display panel and removes the protection film before assembling it. At this time, if the OEL display module has been stored for a long period of

time, residue adhesive material of the protection film may remain on the surface of the display panel after removed of the film. In such case, remove the residue material by the method introduced in the above Section 5).

- 12) If electric current is applied when the OEL display module is being dewed or when it is placed under high humidity environments, the electrodes may be corroded and be careful to avoid the above.

8.2 Storage Precautions

- 1) When storing OEL display modules, put them in static electricity preventive bags avoiding exposure to direct sun light nor to lights of fluorescent lamps. and, also, avoiding high temperature and high humidity environment or low temperature (less than 0°C) environments. (We recommend you to store these modules in the packaged state when they were shipped from WiseChip Semiconductor Inc.)
At that time, be careful not to let water drops adhere to the packages or bags nor let dewing occur with them.
- 2) If electric current is applied when water drops are adhering to the surface of the OEL display module, when the OEL display module is being dewed or when it is placed under high humidity environments, the electrodes may be corroded and be careful about the above.

8.3 Designing Precautions

- 1) The absolute maximum ratings are the ratings which cannot be exceeded for OEL display module, and if these values are exceeded, panel damage may be happen.
- 2) To prevent occurrence of malfunctioning by noise, pay attention to satisfy the V_{IL} and V_{IH} specifications and, at the same time, to make the signal line cable as short as possible.
- 3) We recommend you to install excess current preventive unit (fuses, etc.) to the power circuit (V_{DD}). (Recommend value: 0.5A)
- 4) Pay sufficient attention to avoid occurrence of mutual noise interference with the neighboring devices.
- 5) As for EMI, take necessary measures on the equipment side basically.
- 6) When fastening the OEL display module, fasten the external plastic housing section.
- 7) If power supply to the OEL display module is forcibly shut down by such errors as taking out the main battery while the OEL display panel is in operation, we cannot guarantee the quality of this OEL display module.
- 8) The electric potential to be connected to the rear face of the IC chip should be as follows: [SSD1320](#)
* Connection (contact) to any other potential than the above may lead to rupture of the IC.

8.4 Precautions when disposing of the OEL display modules

- 1) Request the qualified companies to handle industrial wastes when disposing of the OEL display modules. Or, when burning them, be sure to observe the environmental and hygienic laws and regulations.

8.5 Other Precautions

- 1) When an OEL display module is operated for a long of time with fixed pattern may remain as an after image or slight contrast deviation may occur.
Nonetheless, if the operation is interrupted and left unused for a while, normal state can be restored. Also, there will be no problem in the reliability of the module.
- 2) To protect OEL display modules from performance drops by static electricity rapture, etc., do not touch the following sections whenever possible while handling the OEL display modules.
 - * Pins and electrodes
 - * Pattern layouts such as the FPC
- 3) With this OEL display module, the OEL driver is being exposed. Generally speaking, semiconductor elements change their characteristics when light is radiated according to the

principle of the solar battery. Consequently, if this OEL driver is exposed to light, malfunctioning may occur.

- * Design the product and installation method so that the OEL driver may be shielded from light in actual usage.
 - * Design the product and installation method so that the OEL driver may be shielded from light during the inspection processes.
- 4) Although this OEL display module stores the operation state data by the commands and the indication data, when excessive external noise, etc. enters into the module, the internal status may be changed. It therefore is necessary to take appropriate measures to suppress noise generation or to protect from influences of noise on the system design.
 - 5) We recommend you to construct its software to make periodical refreshment of the operation statuses (re-setting of the commands and re-transference of the display data) to cope with catastrophic noise.

CONFIDENTIAL

Warranty:

The warranty period shall last twelve (12) months from the date of delivery. Buyer shall be completed to assemble all the processes within the effective twelve (12) months. WiseChip Semiconductor Inc. shall be liable for replacing any products which contain defective material or process which do not conform to the product specification, applicable drawings and specifications during the warranty period. All products must be preserved, handled and appearance to permit efficient handling during warranty period. The warranty coverage would be exclusive while the returned goods are out of the terms above.

Notice:

No part of this material may be reproduced or duplicated in any form or by any means without the written permission of WiseChip Semiconductor Inc. WiseChip Semiconductor Inc. reserves the right to make changes to this material without notice. WiseChip Semiconductor Inc. does not assume any liability of any kind arising out of any inaccuracies contained in this material or due to its application or use in any product or circuit and, further, there is no representation that this material is applicable to products requiring high level reliability, such as, medical products. Moreover, no license to any intellectual property rights is granted by implication or otherwise, and there is no representation or warranty that anything made in accordance with this material will be free from any patent or copyright infringement of a third party. This material or portions thereof may contain technology or the subject relating to strategic products under the control of Foreign Exchange and Foreign Trade Law of Taiwan and may require an export license from the Ministry of International Trade and Industry or other approval from another government agency.

© WiseChip Semiconductor Inc. 2017, All rights reserved.

All other product names mentioned herein are trademarks and/or registered trademarks of their respective companies.

X-ON Electronics

Largest Supplier of Electrical and Electronic Components

Click to view similar products for [Display Development Tools](#) category:

Click to view products by [SparkFun](#) manufacturer:

Other Similar products are found below :

[KIT 60121-3](#) [S5U13U11P00C100](#) [MAX14521EEVKIT](#) [KIT 60145-3](#) [S5U13748P00C100](#) [DFR0413](#) [3248](#) [DLPLCR90EVM](#)
[MAX20069EVKIT#](#) [KIT95000-3](#) [LCD-16396](#) [PIM370](#) [1109](#) [MCIMX-LVDS1](#) [MIKROE-2449](#) [MIKROE-2453](#) [131](#) [DEV-13628](#) [1590](#)
[MIKROE-2269](#) [1601](#) [1770](#) [1947](#) [1983](#) [1987](#) [2050](#) [2218](#) [2219](#) [2260](#) [2345](#) [2418](#) [2423](#) [2454](#) [2455](#) [2478](#) [2674](#) [SK-220RD-PI](#) [FIT0477](#) [333](#)
[1774](#) [334](#) [TE-M321-SDK](#) [DFR0428](#) [cs-epapersk-03](#) [338](#) [DEV-14442](#) [FIT0478](#) [cs-paperino-01](#) [OM-E-OLE](#) [ALTHSMCMIPILCD](#)