AT42QT1010 Data Sheet

Introduction

The AT42QT1010 is a digital burst mode charge-transfer sensor that is capable of detecting near proximity or touch, making it ideal for implementing touch controls.

The QT1010 is designed specifically for human interfaces like control panels, appliances, toys, lighting controls, or anywhere a mechanical switch or button may be found. It includes all hardware and signal processing functions necessary to provide stable sensing under a wide variety of changing conditions. Only a single low-cost capacitor is required for operation.

Features

- Number of Keys:
 - One – configurable as either a single key or a proximity sensor
- Technology:
 - Patented spread-spectrum charge-transfer (direct mode)
- Key outline sizes:
 - 6 mm × 6 mm or larger (panel thickness dependent); widely different sizes and shapes possible
- Electrode design:
 - Solid or ring electrode shapes
- PCB Layers required:
 - One
- Electrode materials:
 - Etched copper, silver, carbon, Indium Tin Oxide (ITO)
- Electrode substrates:
 - PCB, FPCB, plastic films, glass
- Panel materials:
 - Plastic, glass, composites, painted surfaces (low particle density metallic paints possible)
- Panel thickness:
 - Up to 12 mm glass, 6 mm plastic (electrode size and Cs dependent)
- Key sensitivity:
 - Settable via capacitor (Cs)
- Interface:
 - Digital output, active high
- Moisture tolerance:
 - Increased moisture tolerance based on hardware design and firmware tuning
- Operating Voltage:

- 1.8 V – 5.5 V; 17 μ A at 1.8 V typical
- Package:
 - 6-pin SOT23-6 RoHS compliant
 - 8-pin UDFN/USON RoHS compliant
- Signal processing:
 - Self-calibration, auto drift compensation, noise filtering
- Applications:
 - Control panels, consumer appliances, proximity sensor applications, toys, lighting controls, mechanical switch or button,
- Patents:
 - QTouch[®] technology (patented charge-transfer method)
 - HeartBeat (monitors health of device)

Table of Contents

Introduction.....	1
Features.....	1
1. Pinout and Schematic.....	5
1.1. Pinout Configurations.....	5
1.2. Pin Descriptions.....	5
1.3. Schematics.....	6
2. Overview of the AT42QT1010.....	8
2.1. Introduction.....	8
2.2. Basic Operation.....	8
2.3. Electrode Drive.....	8
2.4. Sensitivity.....	8
3. Operation Specifics.....	10
3.1. Run Modes.....	10
3.2. Threshold.....	11
3.3. Max On-duration.....	12
3.4. Detect Integrator.....	12
3.5. Forced Sensor Recalibration.....	12
3.6. Drift Compensation.....	12
3.7. Response Time.....	13
3.8. Spread Spectrum.....	13
3.9. Output Features.....	13
4. Circuit Guidelines.....	15
4.1. More Information.....	15
4.2. Sample Capacitor.....	15
4.3. UDFN/USON Package Restrictions.....	15
4.4. Power Supply and PCB Layout.....	15
4.5. Power On.....	16
5. Specifications.....	17
5.1. Absolute Maximum Specifications.....	17
5.2. Recommended Operating Conditions.....	17
5.3. AC Specifications.....	17
5.4. Signal Processing.....	19
5.5. DC Specifications.....	20
5.6. Mechanical Dimensions.....	21
5.7. Part Marking.....	23
5.8. Part Number.....	23
5.9. Moisture Sensitivity Level (MSL).....	24
6. Associated Documents.....	25

7. Revision History.....	26
The Microchip Web Site.....	27
Customer Change Notification Service.....	27
Customer Support.....	27
Microchip Devices Code Protection Feature.....	27
Legal Notice.....	28
Trademarks.....	28
Quality Management System Certified by DNV.....	29
Worldwide Sales and Service.....	30

1. Pinout and Schematic

1.1 Pinout Configurations

1.1.1 6-pin SOT23-6

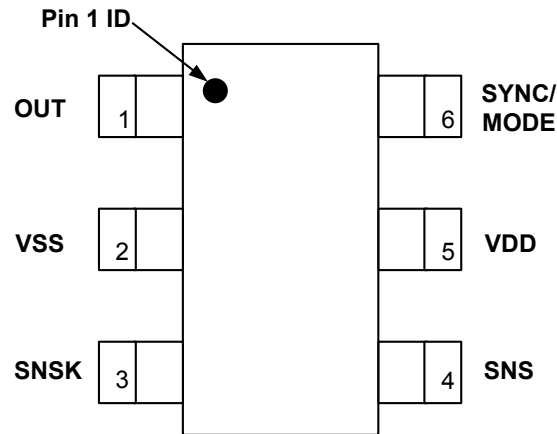

1.1.2 8-pin UDFN/USON

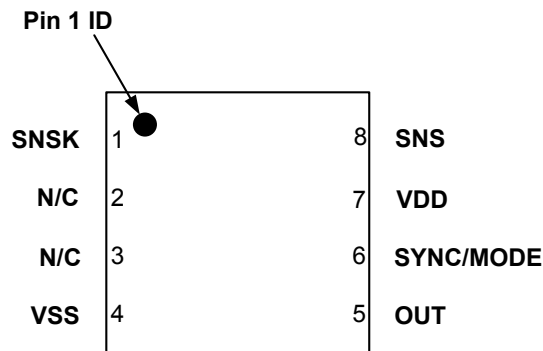

1.2 Pin Descriptions

1.2.1 6-pin SOT23-6

Table 1-1. Pin Listing

Name	Pin	Type	Comments	If Unused, Connect To...
OUT	1	O	Output state	—
VSS	2	P	Supply ground	—
SNSK	3	I/O	Sense pin	Cs + Key
SNS	4	I/O	Sense pin	Cs
VDD	5	P	Power	—
SYNC	6	I	SYNC and Mode Input	Pin is either SYNC/Slow/Fast Mode, depending on logic level applied (see Section 3.1)

Legend: I = Input only, O = Output only, push-pull, I/O = Input/output, OD = Open drain output, P = Ground or power

1.2.2 8-pin UDFN/USON

Table 1-2. Pin Listing

Name	Pin	Type	Comments	If Unused, Connect To...
SNSK	1	I/O	Sense pin	Cs + Key
N/C	2	—	No connection	—
N/C	3	—	No connection	—
VSS	4	P	Supply ground	—
OUT	5	O	Output state	—
SYNC/ MODE	6	I	SYNC and Mode Input	Pin is either SYNC/Slow/Fast Mode, depending on logic level applied (see Section 3.1)
VDD	7	P	Power	—
SNS	8	I/O	Sense pin	Cs

Legend: I = Input only, O = Output only, push-pull, I/O = Input/output, OD = Open drain output, P = Ground or power

1.3 Schematics

1.3.1 6-pin SOT23-6

Figure 1-1. Basic Circuit Configuration



Note: A bypass capacitor should be tightly wired between Vdd and Vss and kept close to pin 5.

1.3.2 8-pin UDFN/USON

Figure 1-2. Basic Circuit Configuration



Note: A bypass capacitor should be tightly wired between Vdd and Vss and kept close to pin 5.

2. Overview of the AT42QT1010

2.1 Introduction

The AT42QT1010 is a digital burst mode charge-transfer sensor that is capable of detecting near-proximity or touch, making it ideal for implementing touch controls.

With the proper electrode and circuit design, the self-contained digital IC will project a touch or proximity field to several centimeters through any dielectric like glass, plastic, stone, ceramic, and even most kinds of wood. It can also turn small metal-bearing objects into intrinsic sensors, making them responsive to proximity or touch. This capability, coupled with its ability to self-calibrate, can lead to entirely new product concepts.

The QT1010 is designed specifically for human interfaces like control panels, appliances, toys, lighting controls, or anywhere a mechanical switch or button may be found. It includes all hardware and signal processing functions necessary to provide stable sensing under a wide variety of changing conditions. Only a single low-cost capacitor is required for operation.

2.2 Basic Operation

[Figure 1-1](#) and [Figure 1-2](#) show basic circuits.

The QT1010 employs bursts of charge-transfer cycles to acquire its signal. Burst mode permits power consumption in the microamp range, dramatically reduces RF emissions, lowers susceptibility to EMI, and yet permits excellent response time. Internally the signals are digitally processed to reject impulse noise, using a “consensus” filter which requires four consecutive confirmations of a detection before the output is activated.

The QT switches and charge measurement hardware functions are all internal to the QT1010.

2.3 Electrode Drive

For optimum noise immunity, the electrode should only be connected to SNSK.

In all cases, the rule $C_s \gg C_x$ must be observed for proper operation; a typical load capacitance (C_x) ranges from 5–20 pF while C_s is usually about 2–50 nF.

Increasing amounts of C_x destroy gain; therefore, it is important to limit the amount of stray capacitance on both SNS terminals. This can be done, for example, by minimizing trace lengths and widths, and keeping these traces away from power or ground traces or copper pours.

The traces and any components associated with SNS and SNSK will become touch sensitive and should be treated with caution to limit the touch area to the desired location.

A series resistor, R_s , should be placed in line with SNSK to the electrode to suppress ESD and EMC effects.

2.4 Sensitivity

2.4.1 Introduction

The sensitivity on the QT1010 is a function of things like the value of C_s , electrode size and capacitance, electrode shape and orientation, the composition and aspect of the object to be sensed, the thickness

and composition of any overlying panel material, and the degree of ground coupling of both sensor and object.

2.4.2 Increasing Sensitivity

In some cases it may be desirable to increase sensitivity; for example, when using the sensor with very thick panels having a low dielectric constant, or when the device is used as a proximity sensor. Sensitivity can often be increased by using a larger electrode or reducing panel thickness. Increasing electrode size can have diminishing returns, since high values of C_x will reduce sensor gain.

The value of C_s also has a dramatic effect on sensitivity, and this can be increased in value with the trade-off of slower response time and more power. Increasing the electrode's surface area will not substantially increase touch sensitivity if its diameter is already much larger in surface area than the object being detected. Panel material can also be changed to one having a higher dielectric constant, which will better help to propagate the field.

In the case of proximity detection, usually the object being detected is on an approaching hand, so a larger surface area can be effective.

Ground planes around and under the electrode and its SNSK trace will cause high C_x loading and destroy gain. The possible signal-to-noise ratio benefits of ground area are more than negated by the decreased gain from the circuit so ground areas around electrodes are discouraged. Metal areas near the electrode will reduce the field strength and increase C_x loading and should be avoided, if possible. Keep ground away from the electrodes and traces.

2.4.3 Decreasing Sensitivity

In some cases the QT1010 may be too sensitive. In this case gain can be easily lowered further by decreasing C_s .

2.4.4 Proximity Sensing

By increasing the sensitivity, the QT1010 can be used as a very effective proximity sensor, allowing the presence of a nearby object (typically a hand) to be detected.

In this scenario, as the object being sensed is typically a hand, very large electrode sizes can be used, which is extremely effective in increasing the sensitivity of the detector. In this case, the value of C_s will also need to be increased to ensure improved sensitivity, as mentioned in [Section 2.4.2](#). Note that, although this affects the responsiveness of the sensor, it is less of an issue in proximity sensing applications; in such applications it is necessary to detect simply the presence of a large object, rather than a small, precise touch.

3. Operation Specifics

3.1 Run Modes

3.1.1 Introduction

The QT1010 has three running modes which depend on the state of the SYNC pin (high or low).

3.1.2 Fast Mode

The QT1010 runs in Fast mode if the SYNC pin is permanently high. In this mode the QT1010 runs at maximum speed at the expense of increased current consumption. Fast mode is useful when speed of response is the prime design requirement. The delay between bursts in Fast mode is approximately 1 ms, as shown in the following figure.

Figure 3-1. Fast Mode Bursts (SYNC Held High)



3.1.3 Low Power Mode

The QT1010 runs in Low Power (LP) mode if the SYNC pin is held low. In this mode it sleeps for approximately 80 ms at the end of each burst, saving power but slowing response. On detecting a possible key touch, it temporarily switches to Fast mode until either the key touch is confirmed or found to be spurious (via the detect integration process). It then returns to LP mode after the key touch is resolved, as shown in the following figure.

Figure 3-2. Low Power Mode (SYNC Held Low)

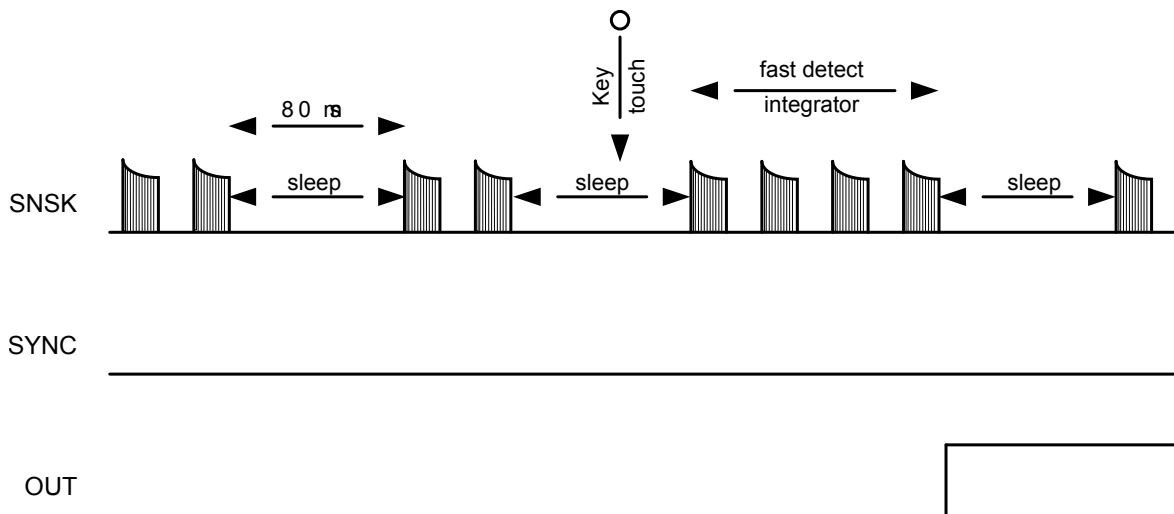

3.1.4 SYNC Mode

It is possible to synchronize the device to an external clock source by placing an appropriate waveform on the SYNC pin. SYNC mode can synchronize multiple QT1010 devices to each other to prevent cross-

interference, or it can be used to enhance noise immunity from low frequency sources such as 50Hz or 60Hz mains signals.

The SYNC pin is sampled at the end of each burst. If the device is in Fast mode and the SYNC pin is sampled high, then the device continues to operate in Fast mode (Figure 3-1). If SYNC is sampled low, then the device goes to sleep. From then on, it will operate in SYNC mode (Figure 3-2). Therefore, to guarantee entry into SYNC mode, the low period of the SYNC signal should be longer than the burst length (Figure 3-3).

Figure 3-3. SYNC Mode (Triggered by SYNC Edges)



However, once SYNC mode has been entered, if the SYNC signal consists of a series of short pulses ($>10 \mu\text{s}$), then a burst will only occur on the falling edge of each pulse (Figure 3-4) instead of on each change of SYNC signal, as normal (Figure 3-3).

In SYNC mode, the device will sleep after each measurement burst (just as in LP mode) but will be awakened by a change in the SYNC signal in either direction, resulting in a new measurement burst. If SYNC remains unchanged for a period longer than the LP mode sleep period (about 80 ms), the device will resume operation in either Fast or LP mode depending on the level of the SYNC pin (Figure 3-3).

There is no Detect Integrator (DI) in SYNC mode (each touch is a detection), but the Max On-duration will depend on the time between SYNC pulses, refer to [Max On-duration](#) and [Section 3.4](#). Recalibration timeout is a fixed number of measurements so it will vary with the SYNC period.

Figure 3-4. SYNC Mode (Short Pulses)

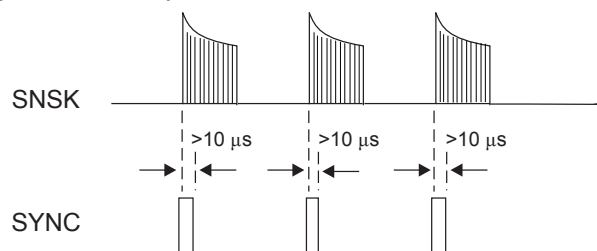

3.2 Threshold

The internal signal threshold level is fixed at 10 counts of change with respect to the internal reference level, which in turn adjusts itself slowly in accordance with the drift compensation mechanism.

The QT1010 employs a hysteresis dropout of two counts of the delta between the reference and threshold levels.

3.3 Max On-duration

If an object or material obstructs the sense pad, the signal may rise enough to create a detection, preventing further operation. To prevent this, the sensor includes a timer which monitors detections. If a detection exceeds the timer setting, the sensor performs a full recalibration. This is known as the Max On-duration feature and is set to ~60s (at 3V in LP mode). This will vary slightly with C_s and if SYNC mode is used. As the internal timebase for Max On-duration is determined by the burst rate, the use of SYNC can cause dramatic changes in this parameter depending on the SYNC pulse spacing. For example, at 60Hz SYNC mode the Max On-duration will be ~6s at 3V.

3.4 Detect Integrator

It is desirable to suppress detections generated by electrical noise or from quick brushes with an object. To accomplish this, the QT1010 incorporates a Detect Integration (DI) counter that increments with each detection until a limit is reached, after which the output is activated. If no detection is sensed prior to the final count, the counter is reset immediately to zero. In the QT1010, the required count is four. In LP mode the device will switch to Fast mode temporarily in order to resolve the detection more quickly; after a touch is either confirmed or denied, the device will revert back to normal LP mode operation automatically.

The DI can also be viewed as a “consensus filter” that requires four successive detections to create an output.

3.5 Forced Sensor Recalibration

The QT1010 has no recalibration pin; a forced recalibration is accomplished when the device is powered up or after the recalibration timeout. However, supply drain is low so it is a simple matter to treat the entire IC as a controllable load; driving the QT1010's Vdd pin directly from another logic gate or a microcontroller port will serve as both power and “forced recalibration”. The source resistance of most CMOS gates and microcontrollers is low enough to provide direct power without problem.

3.6 Drift Compensation

Signal drift can occur because of changes in C_x and C_s over time. It is crucial that drift be compensated for; otherwise, false detections, non-detections, and sensitivity shifts will follow.

Drift compensation ([Figure 3-5](#)) is performed by making the reference level track the raw signal at a slow rate, but only while there is no detection in effect. The rate of adjustment must be performed slowly, otherwise legitimate detections could be ignored. The QT1010 drift compensates using a slew-rate limited change to the reference level; the threshold and hysteresis values are slaved to this reference.

Once an object is sensed, the drift compensation mechanism ceases since the signal is legitimately high, and therefore should not cause the reference level to change.

Figure 3-5. Drift Compensation

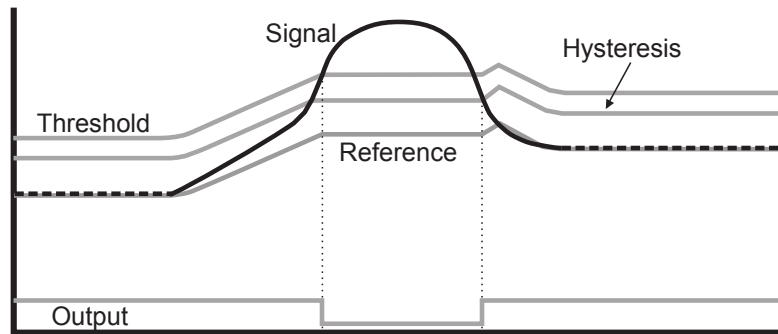

The QT1010 drift compensation is asymmetric; the reference level drift-compensates in one direction faster than it does in the other. Specifically, it compensates faster for decreasing signals than for increasing signals. Increasing signals should not be compensated for quickly, since an approaching finger could be compensated for partially or entirely before even approaching the sense electrode. However, an obstruction over the sense pad, for which the sensor has already made full allowance, could suddenly be removed leaving the sensor with an artificially elevated reference level and thus become insensitive to touch. In this latter case, the sensor will compensate for the object's removal very quickly, usually in only a few seconds.

With large values of C_s and small values of C_x , drift compensation will appear to operate more slowly than with the converse. Note that the positive and negative drift compensation rates are different.

3.7 Response Time

The QT1010's response time is highly dependent on run mode and burst length, which in turn is dependent on C_s and C_x . With increasing C_s , response time slows, while increasing levels of C_x reduce response time. The response time will also be a lot slower in LP or SYNC mode due to a longer time between burst measurements.

3.8 Spread Spectrum

The QT1010 modulates its internal oscillator by $\pm 7.5\%$ during the measurement burst. This spreads the generated noise over a wider band, reducing emission levels. This also reduces susceptibility since there is no longer a single fundamental burst frequency.

3.9 Output Features

3.9.1 Output

The output of the QT1010 is active-high upon detection.

The output will remain active-high for the duration of the detection, or until the Max On-duration expires, whichever occurs first. If a Max On-duration timeout occurs first, the sensor performs a full recalibration and the output becomes inactive (low) until the next detection.

3.9.2 HeartBeat Output

The QT1010 output has a HeartBeat "health" indicator superimposed on it in all modes. This operates by taking the output pin into a three-state mode for $15\ \mu\text{s}$, once before every QT burst. This output state can be used to determine that the sensor is operating properly, using one of several simple methods, or it can be ignored.

The HeartBeat indicator can be sampled by using a pull-up resistor on the OUT pin (Figure 3-6), and feeding the resulting positive-going pulse into a counter, flip flop, one-shot, or other circuit. The pulses will only be visible when the chip is not detecting a touch.

Figure 3-6. Obtaining HeartBeat Pulses with a Pull-up Resistor (SOT23-6)

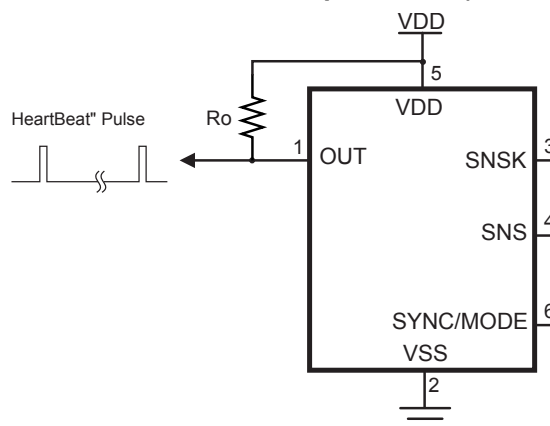

If the sensor is wired to a microcontroller as shown in Figure 3-7, the microcontroller can reconfigure the load resistor to either Vss or Vdd depending on the output state of the QT1010, so that the pulses are evident in either state.

Figure 3-7. Using a Microcontroller to Obtain HeartBeat Pulses in Either Output State (SOT23-6)

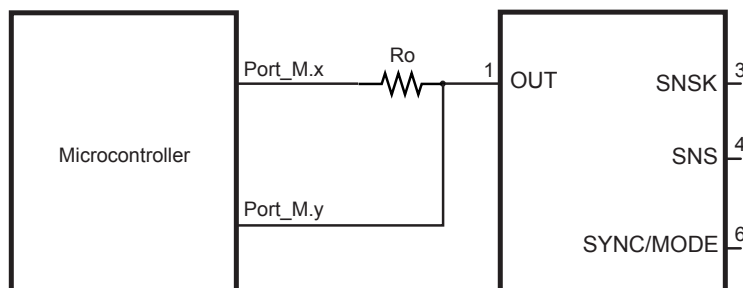

Electromechanical devices like relays will usually ignore the short HeartBeat pulse. The pulse also has too low a duty cycle to visibly affect LEDs. It can be filtered completely if desired, by adding an RC filter to the output, or if interfacing directly and only to a high-impedance CMOS input, by doing nothing or at most adding a small noncritical capacitor from OUT to Vss.

3.9.3 Output Drive

The OUT pin is active high and can sink or source up to 2 mA. When a large value of Cs (>20 nF) is used, the OUT current should be limited to <1 mA to prevent gain-shifting side effects, which happen when the load current creates voltage drops on the die and bonding wires; these small shifts can materially influence the signal level to cause detection instability.

4. Circuit Guidelines

4.1 More Information

Refer to Application Note QTAN0002, "Secrets of a Successful QTouch[®] Design", and the "Touch Sensors Design Guide" (both downloadable from <http://www.microchip.com>), for more information on construction and design methods.

4.2 Sample Capacitor

C_s is the charge sensing sample capacitor. The required C_s value depends on the thickness of the panel and its dielectric constant. Thicker panels require larger values of C_s. Typical values are 2 nF to 50 nF depending on the sensitivity required; larger values of C_s demand higher stability and better dielectric to ensure reliable sensing.

The C_s capacitor should be a stable type, such as X7R ceramic or PPS film. For more consistent sensing from unit to unit, 5% tolerance capacitors are recommended. X7R ceramic types can be obtained in 5% tolerance at little or no extra cost. In applications where high sensitivity (long burst length) is required, the use of PPS capacitors is recommended.

For battery powered operation, a higher value sample capacitor is recommended (typical value 8.2 nF).

4.3 UDFN/USON Package Restrictions

The central pad on the underside of the UDFN/USON chip is connected to ground. Do not run any tracks underneath the body of the chip, only ground.

4.4 Power Supply and PCB Layout

See [Section 5.2](#) for the power supply range. At 3V, current drain averages less than 500 μ A in Fast mode.

If the power supply is shared with another electronic system, care should be taken to ensure that the supply is free of digital spikes, sags, and surges which can adversely affect the QT1010. The QT1010 will track slow changes in V_{dd}, but it can be badly affected by rapid voltage fluctuations. It is highly recommended that a separate voltage regulator be used just for the QT1010 to isolate it from power supply shifts caused by other components.

If desired, the supply can be regulated using a Low Dropout (LDO) regulator, although such regulators often have poor transient line and load stability. See Application Note QTAN0002, "Secrets of a Successful QTouch[®] Design" for further information.

Parts placement: The chip should be placed to minimize the SNSK trace length to reduce low frequency pickup, and to reduce stray C_x, which degrades gain. The C_s and R_s resistors (see [Figure 1-1](#)) should be placed as close to the body of the chip as possible so that the trace between R_s and the SNSK pin is very short, thereby reducing the antenna-like ability of this trace to pick up high frequency signals and feed them directly into the chip. A ground plane can be used under the chip and the associated discrete components, but the trace from the R_s resistor and the electrode should not run near ground to reduce loading.

For best EMC performance, the circuit should be made entirely with SMT components.

Electrode trace routing: Keep the electrode trace (and the electrode itself) away from other signal, power, and ground traces including over or next to ground planes. Adjacent switching signals can induce noise onto the sensing signal; any adjacent trace or ground plane next to, or under, the electrode trace will cause an increase in C_x load and desensitize the device.

Note: For proper operation, a 100 nF (0.1 μF) ceramic bypass capacitor must be used directly between V_{dd} and V_{ss} to prevent latch-up if there are substantial V_{dd} transients; for example, during an ESD event. The bypass capacitor should be placed very close to the V_{ss} and V_{dd} pins.

4.5 Power On

On initial power up, the QT1010 requires approximately 100 ms to power on to allow power supplies to stabilize. During this time the OUT pin state is not valid and should be ignored.

5. Specifications

5.1 Absolute Maximum Specifications

Operating temperature	−40°C to +85°C
Storage temperature	−55°C to +125°C
Vdd	0 to +6.5 V
Max continuous pin current, any control or drive pin	±20 mA
Short circuit duration to Vss, any pin	Infinite
Short circuit duration to Vdd, any pin	Infinite
Voltage forced onto any pin	−0.6V to (Vdd + 0.6) V
<p>CAUTION: Stresses beyond those listed under Absolute Maximum Specifications may cause permanent damage to the device. This is a stress rating only and functional operation of the device at these or other conditions beyond those indicated in the operational sections of this specification is not implied. Exposure to absolute maximum specification conditions for extended periods may affect device reliability.</p>	

5.2 Recommended Operating Conditions

Vdd	+1.8 to 5.5 V
Short-term supply ripple + noise	±20 mV
Long-term supply stability	±100 mV
Cs value	2 to 50 nF
Cx value	5 to 50 pF

5.3 AC Specifications

Table 5-1. Vdd = 3.0 V, Cs = 4.7 nF, Cx = 5 pF, Ta = recommended range, unless otherwise noted

Parameter	Description	Min	Typ	Max	Units	Notes
Trc	Recalibration time	–	200	–	ms	Cs, Cx dependent
Tpc	Charge duration	–	3.05	–	µs	±7.5% spread spectrum variation
Tpt	Transfer duration	–	9.0	–	µs	±7.5% spread spectrum variation
Tg1	Time between end of burst and start of the next (Fast mode)	–	1.2	–	ms	

Parameter	Description	Min	Typ	Max	Units	Notes
Tg2	Time between end of burst and start of the next (LP mode)	–	80	–	ms	Increases with decreasing Vdd See Figure 5-1
Tbl	Burst length	–	2.45	–	ms	Vdd, Cs and Cx dependent. See Section 4.2 for capacitor selection.
Tr	Response time	–	–	100	ms	
Thb	HeartBeat pulse width	–	15	–	µs	

Figure 5-1. Tg2 Time Between Bursts (LP Mode)

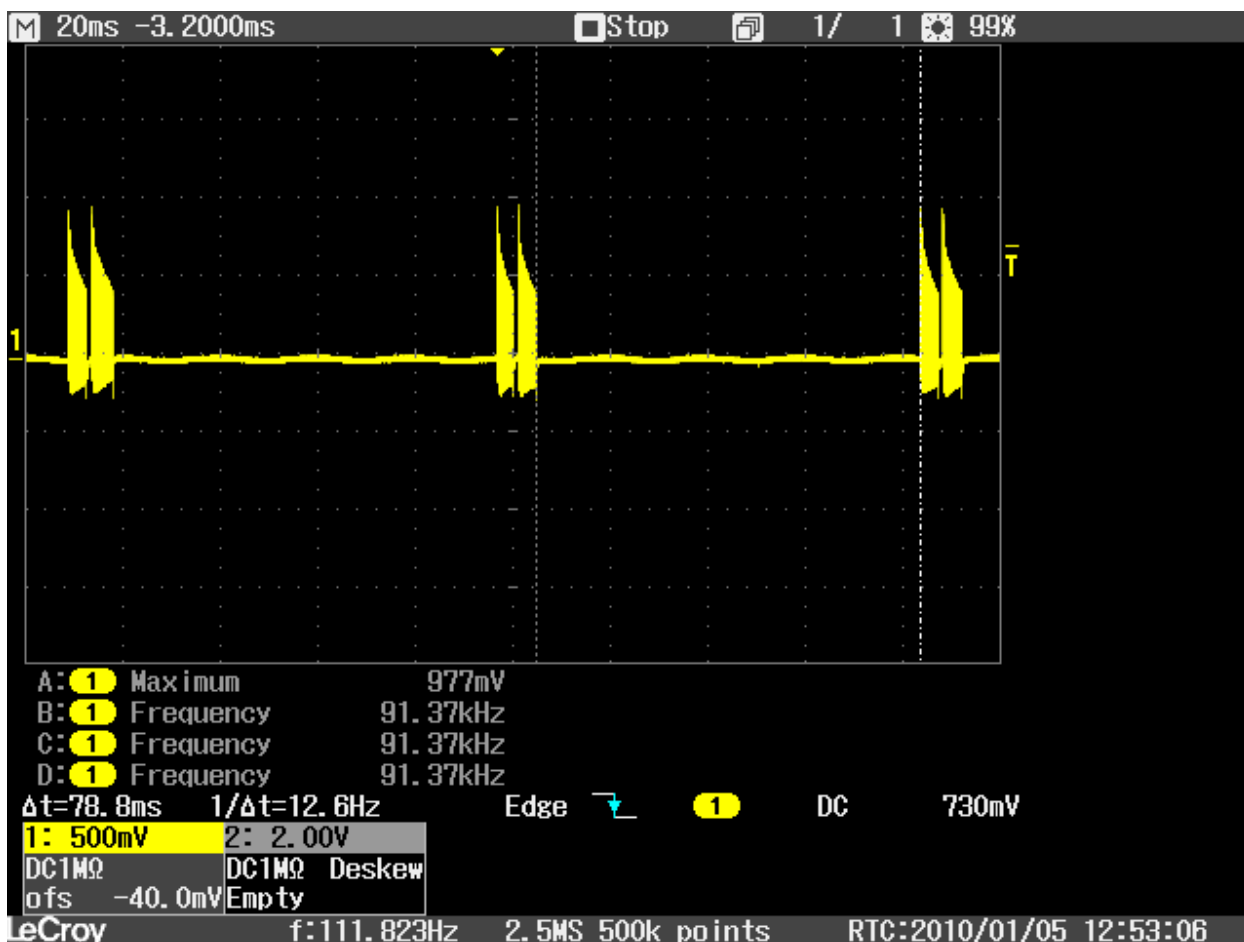
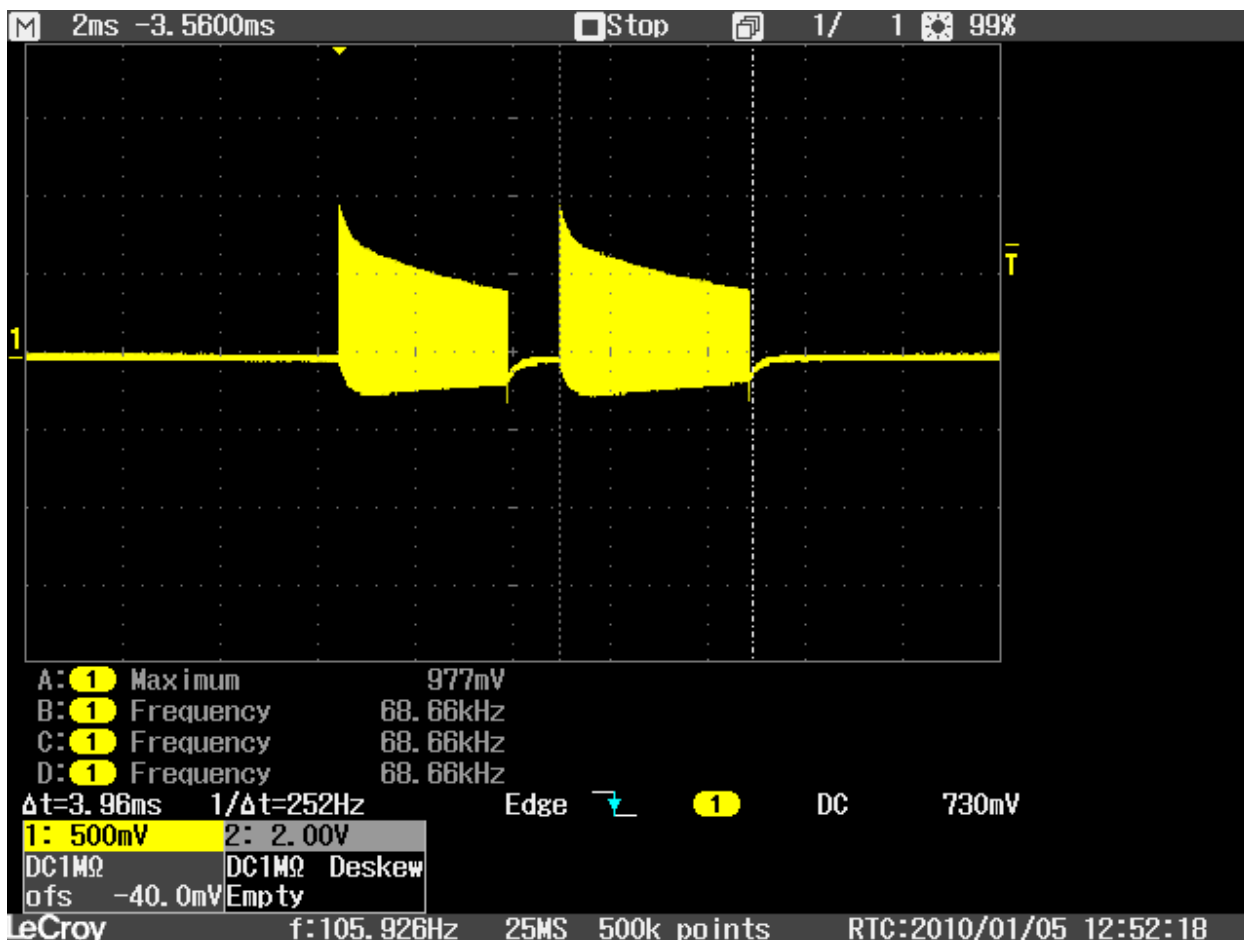

Figure 5-2. Tbl Burst Length



5.4 Signal Processing

Table 5-2. Vdd = 3.0V, Cs = 4.7 nF, Cx = 5 pF, Ta = recommended range, unless otherwise noted

Description	Min	Typ	Max	Units	Notes
Threshold differential	10			counts	
Hysteresis	2			counts	
Consensus filter length	4			samples	
Max on-duration	60			seconds	(At 3 V in LP mode) Will vary in SYNC mode and with Vdd

5.5 DC Specifications

Table 5-3. Vdd = 3.0V, Cs = 4.7 nF, Cx = 5 pF, Ta = recommended range, unless otherwise noted

Parameter	Description	Min	Typ	Max	Units	Notes
Vdd	Supply voltage	1.8		5.5	V	
Idd	Supply current, Fast mode	–	203.0 246.0 378.5 542.5 729.0	–	μA	1.8 V 2.0 V 3.0 V 4.0 V 5.0 V
Iddl	Supply current, LP mode	–	16.5 19.5 34.0 51.5 73.5	–	μA	1.8 V 2.0 V 3.0 V 4.0 V 5.0 V
Vdds	Supply turn-on slope	10	–	–	V/s	Required for proper start-up
Vil	Low input logic level	–	–	0.2 × Vdd 0.3 × Vdd	V	Vdd = 1.8 V – 2.4 V Vdd = 2.4 V – 5.5 V
Vhl	High input logic level	0.7 × Vdd 0.6 × Vdd	–	–	V	Vdd = 1.8 V – 2.4 V Vdd = 2.4 V – 5.5 V
Vol	Low output voltage	–	–	0.5	V	OUT, 4 mA sink
Voh	High output voltage	2.3	–	–	V	OUT, 1 mA source
Iil	Input leakage current	–	<0.05	1	μA	
Cx	Load capacitance range	2	–	50	pF	
Ar	Acquisition resolution	–	9	14	bits	

5.6 Mechanical Dimensions

5.6.1 6-pin SOT23-6

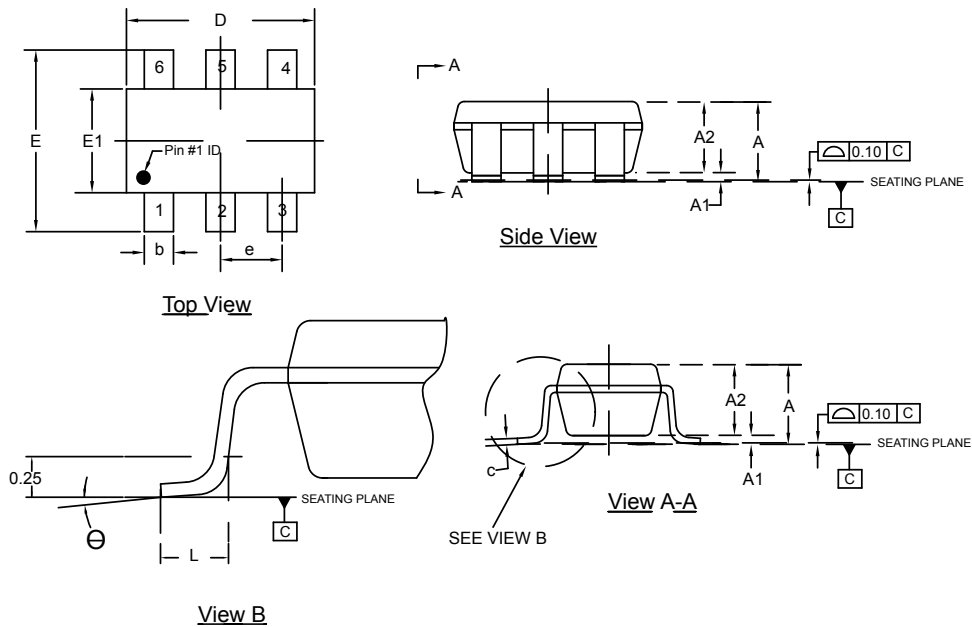

COMMON DIMENSIONS
(Unit of Measure = mm)

SYMBOL	MIN	NOM	MAX	NOTE
A	–	–	1.45	
A1	0	–	0.15	
A2	0.90	–	1.30	
D	2.80	2.90	3.00	2
E	2.60	2.80	3.00	
E1	1.50	1.60	1.75	
L	0.30	0.45	0.55	
e	0.95 BSC			
b	0.30	–	0.50	3
c	0.09	–	0.20	
q	0°	–	8°	

- Notes:
1. This package is compliant with JEDEC specification MO-178 Variation AB.
 2. Dimension D does not include mold Flash, protrusions or gate burrs. Mold Flash, protrusion or gate burrs shall not exceed 0.25 mm per end.
 3. Dimension b does not include dambar protrusion. Allowable dambar protrusion shall not cause the lead width to exceed the maximum b dimension by more than 0.08 mm
 4. Die is facing down after trim/form.

1/25/13

<p>Package Drawing Contact: packagedrawings@atmel.com</p>	<p>TITLE</p> <p>6ST1, 6-lead, 2.90 x 1.60 mm Plastic Small Outline Package (SOT23)</p>	<p>GPC</p> <p>TAQ</p>	<p>DRAWING NO.</p> <p>6ST1</p>	<p>REV.</p> <p>B</p>

Note: For the most current package drawings, please see the Microchip Packaging Specification located at <http://www.microchip.com/packaging>

5.6.2 8-pin UDFN/USON



Note: For the most current package drawings, please see the Microchip Packaging Specification located at <http://www.microchip.com/packaging>

5.7 Part Marking

5.7.1 AT42QT1010– 6-pin SOT23-6

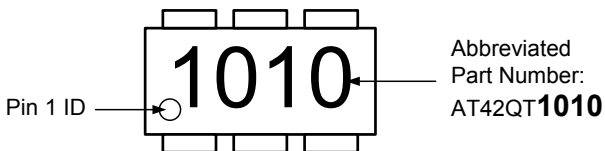

Note: Samples of the AT42QT1010 may also be marked T10E.

5.7.2 AT42QT1010 – 8-pin UDFN/USON

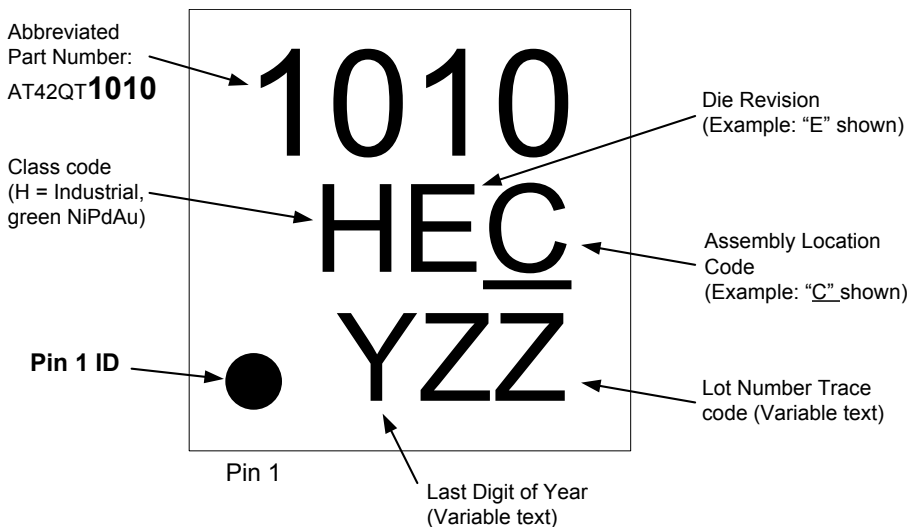

Note: Samples of the AT42QT1010 may also be marked T10

5.8 Part Number

Part Number	Description
AT42QT1010 ⁽¹⁾	6-pin SOT23 RoHS compliant IC
AT42QT1010-TSHR	6-pin SOT23 RoHS compliant IC
AT42QT1010-MAH	8-pin UDFN/USON RoHS compliant IC

Notes: 1. Marking details:
 Top mark 1st line: ddddTY
 Top mark 2nd line: wwxxx

dddd= device, special code
 T= Type
 Y= Year last digit
 ww= calendar workweek
 xxx = trace code

5.9 Moisture Sensitivity Level (MSL)

MSL Rating	Peak Body Temperature	Specifications
MSL1	260°C	IPC/JEDEC J-STD-020

6. Associated Documents

For additional information, refer to the following document (downloadable from the Touch Technology area of the Microchip website, www.microchip.com):

- Touch Sensors Design Guide
- QTAN0002 – Secrets of a Successful QTouch[®] Design

7. Revision History

Revision No.	History
Revision A – May 2009	Initial release
Revision B – August 2009	Update for chip revision 2.2
Revision C – August 2009	Minor update for clarity
Revision D – January 2010	Power specifications updated for revision 2.4.1
Revision E – January 2010	Part markings updated
Revision F – February 2010	MSL specification revised Other minor updates
Revision G – March 2010	Update for chip revision 2.6 • Migration advice added
Revision H – May 2010	UDFN/USON package added
Revision I – May 2013	Applied new template
DS40001946A – August 2017	Part marking clarification added. Replaces Atmel document 9541I.

The Microchip Web Site

Microchip provides online support via our web site at <http://www.microchip.com/>. This web site is used as a means to make files and information easily available to customers. Accessible by using your favorite Internet browser, the web site contains the following information:

- **Product Support** – Data sheets and errata, application notes and sample programs, design resources, user's guides and hardware support documents, latest software releases and archived software
- **General Technical Support** – Frequently Asked Questions (FAQ), technical support requests, online discussion groups, Microchip consultant program member listing
- **Business of Microchip** – Product selector and ordering guides, latest Microchip press releases, listing of seminars and events, listings of Microchip sales offices, distributors and factory representatives

Customer Change Notification Service

Microchip's customer notification service helps keep customers current on Microchip products. Subscribers will receive e-mail notification whenever there are changes, updates, revisions or errata related to a specified product family or development tool of interest.

To register, access the Microchip web site at <http://www.microchip.com/>. Under "Support", click on "Customer Change Notification" and follow the registration instructions.

Customer Support

Users of Microchip products can receive assistance through several channels:

- Distributor or Representative
- Local Sales Office
- Field Application Engineer (FAE)
- Technical Support

Customers should contact their distributor, representative or Field Application Engineer (FAE) for support. Local sales offices are also available to help customers. A listing of sales offices and locations is included in the back of this document.

Technical support is available through the web site at: <http://www.microchip.com/support>

Microchip Devices Code Protection Feature

Note the following details of the code protection feature on Microchip devices:

- Microchip products meet the specification contained in their particular Microchip Data Sheet.
- Microchip believes that its family of products is one of the most secure families of its kind on the market today, when used in the intended manner and under normal conditions.
- There are dishonest and possibly illegal methods used to breach the code protection feature. All of these methods, to our knowledge, require using the Microchip products in a manner outside the operating specifications contained in Microchip's Data Sheets. Most likely, the person doing so is engaged in theft of intellectual property.
- Microchip is willing to work with the customer who is concerned about the integrity of their code.

- Neither Microchip nor any other semiconductor manufacturer can guarantee the security of their code. Code protection does not mean that we are guaranteeing the product as “unbreakable.”

Code protection is constantly evolving. We at Microchip are committed to continuously improving the code protection features of our products. Attempts to break Microchip’s code protection feature may be a violation of the Digital Millennium Copyright Act. If such acts allow unauthorized access to your software or other copyrighted work, you may have a right to sue for relief under that Act.

Legal Notice

Information contained in this publication regarding device applications and the like is provided only for your convenience and may be superseded by updates. It is your responsibility to ensure that your application meets with your specifications. MICROCHIP MAKES NO REPRESENTATIONS OR WARRANTIES OF ANY KIND WHETHER EXPRESS OR IMPLIED, WRITTEN OR ORAL, STATUTORY OR OTHERWISE, RELATED TO THE INFORMATION, INCLUDING BUT NOT LIMITED TO ITS CONDITION, QUALITY, PERFORMANCE, MERCHANTABILITY OR FITNESS FOR PURPOSE. Microchip disclaims all liability arising from this information and its use. Use of Microchip devices in life support and/or safety applications is entirely at the buyer’s risk, and the buyer agrees to defend, indemnify and hold harmless Microchip from any and all damages, claims, suits, or expenses resulting from such use. No licenses are conveyed, implicitly or otherwise, under any Microchip intellectual property rights unless otherwise stated.

Trademarks

The Microchip name and logo, the Microchip logo, AnyRate, AVR, AVR logo, AVR Freaks, BeaconThings, BitCloud, CryptoMemory, CryptoRF, dsPIC, FlashFlex, flexPWR, Heldo, JukeBlox, KeeLoq, KeeLoq logo, Klear, LANCheck, LINK MD, maXStylus, maXTouch, MediaLB, megaAVR, MOST, MOST logo, MPLAB, OptoLyzer, PIC, picoPower, PICSTART, PIC32 logo, Prochip Designer, QTouch, RightTouch, SAM-BA, SpyNIC, SST, SST Logo, SuperFlash, tinyAVR, UNI/O, and XMEGA are registered trademarks of Microchip Technology Incorporated in the U.S.A. and other countries.

ClockWorks, The Embedded Control Solutions Company, EtherSynch, Hyper Speed Control, HyperLight Load, IntelliMOS, mTouch, Precision Edge, and Quiet-Wire are registered trademarks of Microchip Technology Incorporated in the U.S.A.

Adjacent Key Suppression, AKS, Analog-for-the-Digital Age, Any Capacitor, AnyIn, AnyOut, BodyCom, chipKIT, chipKIT logo, CodeGuard, CryptoAuthentication, CryptoCompanion, CryptoController, dsPICDEM, dsPICDEM.net, Dynamic Average Matching, DAM, ECAN, EtherGREEN, In-Circuit Serial Programming, ICSP, Inter-Chip Connectivity, JitterBlocker, KlearNet, KlearNet logo, Mindi, MiWi, motorBench, MPASM, MPF, MPLAB Certified logo, MPLIB, MPLINK, MultiTRAK, NetDetach, Omniscient Code Generation, PICDEM, PICDEM.net, PICKit, PICtail, PureSilicon, QMatrix, RightTouch logo, REAL ICE, Ripple Blocker, SAM-ICE, Serial Quad I/O, SMART-I.S., SQI, SuperSwitcher, SuperSwitcher II, Total Endurance, TSHARC, USBCheck, VariSense, ViewSpan, WiperLock, Wireless DNA, and ZENA are trademarks of Microchip Technology Incorporated in the U.S.A. and other countries.

SQTP is a service mark of Microchip Technology Incorporated in the U.S.A.

Silicon Storage Technology is a registered trademark of Microchip Technology Inc. in other countries.

GestIC is a registered trademark of Microchip Technology Germany II GmbH & Co. KG, a subsidiary of Microchip Technology Inc., in other countries.

All other trademarks mentioned herein are property of their respective companies.

© 2017, Microchip Technology Incorporated, Printed in the U.S.A., All Rights Reserved.

ISBN: 978-1-5224-2069-9

Quality Management System Certified by DNV

ISO/TS 16949

Microchip received ISO/TS-16949:2009 certification for its worldwide headquarters, design and wafer fabrication facilities in Chandler and Tempe, Arizona; Gresham, Oregon and design centers in California and India. The Company's quality system processes and procedures are for its PIC[®] MCUs and dsPIC[®] DSCs, KEELOQ[®] code hopping devices, Serial EEPROMs, microperipherals, nonvolatile memory and analog products. In addition, Microchip's quality system for the design and manufacture of development systems is ISO 9001:2000 certified.

Worldwide Sales and Service

AMERICAS	ASIA/PACIFIC	ASIA/PACIFIC	EUROPE
<p>Corporate Office 2355 West Chandler Blvd. Chandler, AZ 85224-6199 Tel: 480-792-7200 Fax: 480-792-7277 Technical Support: http://www.microchip.com/support Web Address: www.microchip.com</p> <p>Atlanta Duluth, GA Tel: 678-957-9614 Fax: 678-957-1455</p> <p>Austin, TX Tel: 512-257-3370</p> <p>Boston Westborough, MA Tel: 774-760-0087 Fax: 774-760-0088</p> <p>Chicago Itasca, IL Tel: 630-285-0071 Fax: 630-285-0075</p> <p>Dallas Addison, TX Tel: 972-818-7423 Fax: 972-818-2924</p> <p>Detroit Novi, MI Tel: 248-848-4000</p> <p>Houston, TX Tel: 281-894-5983</p> <p>Indianapolis Noblesville, IN Tel: 317-773-8323 Fax: 317-773-5453 Tel: 317-536-2380</p> <p>Los Angeles Mission Viejo, CA Tel: 949-462-9523 Fax: 949-462-9608 Tel: 951-273-7800</p> <p>Raleigh, NC Tel: 919-844-7510</p> <p>New York, NY Tel: 631-435-6000</p> <p>San Jose, CA Tel: 408-735-9110 Tel: 408-436-4270</p> <p>Canada - Toronto Tel: 905-695-1980 Fax: 905-695-2078</p>	<p>Asia Pacific Office Suites 3707-14, 37th Floor Tower 6, The Gateway Harbour City, Kowloon</p> <p>Hong Kong Tel: 852-2943-5100 Fax: 852-2401-3431</p> <p>Australia - Sydney Tel: 61-2-9868-6733 Fax: 61-2-9868-6755</p> <p>China - Beijing Tel: 86-10-8569-7000 Fax: 86-10-8528-2104</p> <p>China - Chengdu Tel: 86-28-8665-5511 Fax: 86-28-8665-7889</p> <p>China - Chongqing Tel: 86-23-8980-9588 Fax: 86-23-8980-9500</p> <p>China - Dongguan Tel: 86-769-8702-9880</p> <p>China - Guangzhou Tel: 86-20-8755-8029</p> <p>China - Hangzhou Tel: 86-571-8792-8115 Fax: 86-571-8792-8116</p> <p>China - Hong Kong SAR Tel: 852-2943-5100 Fax: 852-2401-3431</p> <p>China - Nanjing Tel: 86-25-8473-2460 Fax: 86-25-8473-2470</p> <p>China - Qingdao Tel: 86-532-8502-7355 Fax: 86-532-8502-7205</p> <p>China - Shanghai Tel: 86-21-3326-8000 Fax: 86-21-3326-8021</p> <p>China - Shenyang Tel: 86-24-2334-2829 Fax: 86-24-2334-2393</p> <p>China - Shenzhen Tel: 86-755-8864-2200 Fax: 86-755-8203-1760</p> <p>China - Wuhan Tel: 86-27-5980-5300 Fax: 86-27-5980-5118</p> <p>China - Xian Tel: 86-29-8833-7252 Fax: 86-29-8833-7256</p>	<p>China - Xiamen Tel: 86-592-2388138 Fax: 86-592-2388130</p> <p>China - Zhuhai Tel: 86-756-3210040 Fax: 86-756-3210049</p> <p>India - Bangalore Tel: 91-80-3090-4444 Fax: 91-80-3090-4123</p> <p>India - New Delhi Tel: 91-11-4160-8631 Fax: 91-11-4160-8632</p> <p>India - Pune Tel: 91-20-3019-1500</p> <p>Japan - Osaka Tel: 81-6-6152-7160 Fax: 81-6-6152-9310</p> <p>Japan - Tokyo Tel: 81-3-6880-3770 Fax: 81-3-6880-3771</p> <p>Korea - Daegu Tel: 82-53-744-4301 Fax: 82-53-744-4302</p> <p>Korea - Seoul Tel: 82-2-554-7200 Fax: 82-2-558-5932 or 82-2-558-5934</p> <p>Malaysia - Kuala Lumpur Tel: 60-3-6201-9857 Fax: 60-3-6201-9859</p> <p>Malaysia - Penang Tel: 60-4-227-8870 Fax: 60-4-227-4068</p> <p>Philippines - Manila Tel: 63-2-634-9065 Fax: 63-2-634-9069</p> <p>Singapore Tel: 65-6334-8870 Fax: 65-6334-8850</p> <p>Taiwan - Hsin Chu Tel: 886-3-5778-366 Fax: 886-3-5770-955</p> <p>Taiwan - Kaohsiung Tel: 886-7-213-7830</p> <p>Taiwan - Taipei Tel: 886-2-2508-8600 Fax: 886-2-2508-0102</p> <p>Thailand - Bangkok Tel: 66-2-694-1351 Fax: 66-2-694-1350</p>	<p>Austria - Wels Tel: 43-7242-2244-39 Fax: 43-7242-2244-393</p> <p>Denmark - Copenhagen Tel: 45-4450-2828 Fax: 45-4485-2829</p> <p>Finland - Espoo Tel: 358-9-4520-820</p> <p>France - Paris Tel: 33-1-69-53-63-20 Fax: 33-1-69-30-90-79</p> <p>France - Saint Cloud Tel: 33-1-30-60-70-00</p> <p>Germany - Garching Tel: 49-8931-9700</p> <p>Germany - Haan Tel: 49-2129-3766400</p> <p>Germany - Heilbronn Tel: 49-7131-67-3636</p> <p>Germany - Karlsruhe Tel: 49-721-625370</p> <p>Germany - Munich Tel: 49-89-627-144-0 Fax: 49-89-627-144-44</p> <p>Germany - Rosenheim Tel: 49-8031-354-560</p> <p>Israel - Ra'anana Tel: 972-9-744-7705</p> <p>Italy - Milan Tel: 39-0331-742611 Fax: 39-0331-466781</p> <p>Italy - Padova Tel: 39-049-7625286</p> <p>Netherlands - Drunen Tel: 31-416-690399 Fax: 31-416-690340</p> <p>Norway - Trondheim Tel: 47-7289-7561</p> <p>Poland - Warsaw Tel: 48-22-3325737</p> <p>Romania - Bucharest Tel: 40-21-407-87-50</p> <p>Spain - Madrid Tel: 34-91-708-08-90 Fax: 34-91-708-08-91</p> <p>Sweden - Gothenberg Tel: 46-31-704-60-40</p> <p>Sweden - Stockholm Tel: 46-8-5090-4654</p> <p>UK - Wokingham Tel: 44-118-921-5800 Fax: 44-118-921-5820</p>

X-ON Electronics

Largest Supplier of Electrical and Electronic Components

Click to view similar products for [Touch Sensor Development Tools](#) category:

Click to view products by [SparkFun](#) manufacturer:

Other Similar products are found below :

[TSC2100EVM](#) [TSC2003EVM-PDK](#) [ATMXT1066T2-DEV-PCB](#) [ATMXT336UDEVPCB](#) [LC717A00ARGEVK](#) [ATMXT641TDAT-I2C-PCB](#)
[MAX20353EVSYS#](#) [EV14C17A](#) [1374](#) [MIKROE-1906](#) [1602](#) [SEN0164](#) [1982](#) [STEVAL-PCC009V3](#) [ATSAMD20-QTRDEMO](#) [ATQT2-](#)
[XPRO](#) [ATQT6-XPRO](#) [2340](#) [DM160221](#) [DM160229](#) [DM160222](#) [ATQT5-XPRO](#) [DFR0129](#) [SEN0170](#) [SLEXP8019A](#) [SLEXP8018A](#) [1375](#)
[SEN0186](#) [SEN0148](#) [ROB0103](#) [cs-useful-01](#) [DFR0385](#) [SEN0184](#) [SX8651EVKA](#) [1362](#) [1580](#) [2024](#) [3575](#) [4830](#) [AS8579-TS_EK_DB](#)
[ATQT600](#) [IQS227/228ASEV01](#) [SKU-6515](#) [CY3280-MBR2](#) [CY3280-MBR3](#) [DFR0030](#) [DM160219](#) [AC160219](#) [AC320007](#) [ATEVK-](#)
[MXT1066T2-A](#)