



# DATA SHEET

(DOC No. HM01B0-MNA-01FT870-DS)

## HM01B0-MNA-01FT870

Compact Camera Module

*Preliminary version 01 Oct, 2019*

# >> HM01B0-MNA-00FT870

Compact Camera Module



Himax Imaging, Ltd.

<http://www.himax.com.tw>

## **Revision History**

Oct, 2019

Version	Date	Description of changes
01	2019/10/09	New setup.

Himax Imaging, Ltd.  
Confidential  
Do Not Copy

List of Contents

Oct, 2019

1. Sensor Specification 7
1.1 Features 8
1.2 Application 8
1.3 Key parameters 9
1.4 QVGA window readout 10
1.5 Electrical specification 11
1.5.1 Operating ratings 11
1.5.2 DC characteristics 11
1.5.3 Master clock input (MCLK) 12
1.6 Power up sequence 13
2. Camera Module Specification 14
2.1 Pin map and description of camera module 14
2.2 Mechanical drawing of camera module 15
2.3 Application schematic of camera module 16
2.3.1 Reference circuit 16
2.3.2 Layout consideration 16
3. Optical Lens Specification 17
3.1 Mechanical drawing of optical lens 17
4. Image Quality Specification 18
5. Reliability Test Conditions 20
5.1 Test Unit 20
5.2 Test Condition 20
6. Inspection Specification 21
6.1 Sampling Plan 21
6.2 Visual Inspection Method 21
6.3 Inspection Item 21
6.4 Remark 21
6.5 Appearance and Dimension Check 21
7. Package Specification 25
7.1 Label List 25
7.2 Packing (the packaging process is only for understanding) 25
7.3 Carton Packing Drawing 25

Himax Imaging, Ltd. Confidential Do Not Copy

# HM01B0-MNA-01FT870

## Compact Camera Module



Himax Imaging, Ltd.

<http://www.himax.com.tw>

### List of Figures

Oct, 2019

Figure 1.1: QVGA resolution pixel readout .....	10
Figure 1.2: Power up sequence .....	13
Figure 2.1: Mechanical drawing of camera module .....	15
Figure 2.2: Reference circuit of camera module .....	16
Figure 3.1: Mechanical drawing of optical lens .....	17
Figure 7.1: Packing of modules.....	25
Figure 7.2: Carton packing drawing .....	25

Himax Imaging, Ltd.  
Confidential  
Do Not Copy

# >> HM01B0-MNA-01FT870

## Compact Camera Module



Himax Imaging, Ltd.

<http://www.himax.com.tw>

### **List of Tables**

Oct, 2019

Table 1.1: Operating ratings.....	11
Table 1.2: DC characteristics.....	11
Table 1.3: Master Clock (MCLK) timing.....	12
Table 1.4: Power up sequence timing.....	13
Table 2.1: Pin map and description of camera module.....	14
Table 4.1: Image Quality Specification.....	19
Table 5.1: Reliability test condition.....	20
Table 7.1: List of package Label.....	25

Himax Imaging, Ltd.  
Confidential  
Do Not Copy

# HM01B0-MNA-01FT870

Compact Camera Module



Himax Imaging, Ltd.

<http://www.himax.com.tw>

## ***Important Notice***

*Oct, 2019*

### **Disclaimer**

Himax Imaging reserves the right to modify this documentation without prior notice. The information appearing in this publication is believed to be accurate and reliable. However, Himax Imaging makes no warranty for any errors which may appear in this document. Contact Himax Imaging to obtain the latest version of product specifications before placing your order. No responsibility is assumed by Himax Imaging, Ltd. for any infringement of patent or other rights of third parties which may result from its use. Products described herein are intended for use in normal commercial applications. Please note that application circuits illustrated in this document are for reference purposes only.

### **All Rights Reserved**

The following are trademarks of Himax Imaging Ltd.: Himax Imaging, BrightSense, ClearSense, the Himax Imaging logo symbol. The use of any trademark, trade name, or service mark found in this document without the owner's express written consent is strictly prohibited.

Himax Imaging strives to produce quality documentation and welcomes your feedback. Please send comments or suggestions to [hi\\_marketing@himaximaging.com](mailto:hi_marketing@himaximaging.com).

Himax Imaging, Ltd.  
Confidential  
Do Not Copy

# HM01B0-MNA-01FT870

Compact Camera Module



Himax Imaging, Ltd.

<http://www.himax.com.tw>

***Preliminary Version 01***

*Oct, 2019*

## 1. Sensor Specification

The HM01B0 is an Ultra Low Power Image Sensor (**ULPIS**) that enables the integration of an “Always-on” camera for computer vision applications such as gestures, intelligent ambient light and proximity sensing, tracking and object identification. The unique architecture of the sensor enables the sensor to consume very low power of <4mW at QVGA 60FPS, <2mW at QVGA 30FPS, and <1.1mW at QQVGA 30FPS.

The HM01B0 contains 324 x 324 pixel resolutions and supports a 324 x 244 window mode which can be readout at a maximum frame rate of 60FPS, and a 2x2 monochrome binning mode with a maximum frame rate of 120FPS. The video data is transferred over a configurable 1-bit, 4-bit or 8-bit video interface with support for frame and line synchronization. The sensor integrates a black level calibration circuit, automatic exposure and gain control loop, self-oscillator and motion detection circuit with interrupt output to reduce host computation and commands to the sensor to optimize the system power consumption.

The sensor is available in a Chip Scale Package (**CSP**) or Bare Die and measures less than 5mm<sup>2</sup>. The sensor supports single, dual or triple power supply configuration and requires only 3 passive components enabling a highly compact camera module design for devices such as IoT, wearable, smart building, smart phone, tablets and slim notebooks.

Himax Imaging, Ltd. Confidential  
Do Not Copy

## 1.1 Features

- Ultra Low Power Image Sensor designed for Always-on vision devices and applications
- High sensitivity 3.6 $\mu$  BrightSense™ pixel technology
- 324 x 324 active pixel resolution with support for QVGA window, vertical flip and horizontal mirror readout
- <1.1mW QVGA resolution at 30FPS,  
< 2mW QVGA resolution at 30FPS
- Programmable black level calibration target, frame size, frame rate, exposure, analog gain (**up to 8x**) and digital gain (**up to 4x**)
- Automatic exposure and gain control loop with support for 50Hz / 60Hz flicker avoidance
- Flexible 1-bit, 4-bit and 8-bit video data interface with video frame and line sync
- Motion Detection circuit with programmable ROI and detection threshold with digital output to serve as an interrupt
- On-chip self oscillator
- I2C 2-Wire serial interface for register access
- CSP and Bare Die sensor package option
- High CRA for low profile module design

## 1.2 Application

- Cellular and mobile phones
- Digital video camcorders
- PC multimedia
- Tablets

Himax Imaging, Ltd.  
Confidential  
Do Not Copy



## 1.3 Key parameters

Module Parameters	Value
Image sensor part number	HM01B0-MNA
Pixel Array (Active/ Effective)	324 x 324 / 320 x 320
Pixel Size	3.6μm x 3.6μm
Image Diagonal	1.63mm
Optical Format	Full frame 1/11"; QVGA 1/13"
Color Filter Array	Bayer, Monochrome
Shutter Type	Electronic Rolling Shutter
Frame Rate (Max.) (8-bit interface)	8-bit, 320p 45FPS @ 6MHz 8-bit, QVGA 60FPS @ 6MHz
Frame Rate <sub>MAX</sub> (4-bit interface)	8-bit, 320p 45FPS @ 12MHz 8-bit, QVGA 60FPS @ 12MHz
Frame Rate <sub>MAX</sub> (1-bit interface)	8-bit, 320p 30FPS @ 36MHz 8-bit, QVGA 45FPS @ 36MHz
S/N Ratio <sub>MAX</sub>	38.7dB
Dynamic Range (1x / 8x)	64dB / 70dB
Sensitivity @ 530nm	5.6 V / Lux-sec
Pixel CRA <sub>MAX</sub>	30°
Supply Voltage (Typ.)	AVDD 2.8V DVDD 1.5V IOVDD 1.8 / 2.8V
Input Reference Clock	3 – 36MHz
Serial Interface	I2C, 400kHz max.
Video Data Interface	8-bit, 4-bit, 1-bit data output FVLD, LVLD, PCLK
Pixel Clock (PCLK) (MAX.)	36MHz
Output Format	6-bit / 8-bit RAW
Digital Output	Motion Interrupt (Active High)
Control Loop	Black Level, Exposure / Gain
Power Consumption (Typ.)	8-bit, QQVGA 30FPS 1.1mW 8-bit, QVGA 30FPS <2mW 8-bit, QVGA 60FPS <4mW Standby 200μW
Temperature	Operating -20 °C to 85 °C Stable Image 0 °C to 60 °C
Construction	3P+ CG
EFL	0.66 mm ± 5%
BFL	1.04 mm
Image circle	1.83 mm
F/No	2.4
TV distortion	under 4.3%
Field of view	Horizontal 87° Vertical 87° Diagonal 115°
Relative illumination	Over 35%: γ=1.0d
Chief ray angle	30°
Barrel size	M3.5 x P0.20
Holder size	5.0mm x 5.0mm
Total track (Barrel to image)	Y=2.80 ± 0.1 (at inf.)

### 1.4 QVGA window readout

The QVGA sensor window with an active resolution of 324 x 244 pixels is programmed by setting register 0x3010[0] to 1. The location of the windows fixed such that the coordinate of the first pixel read out location is 0, 0.

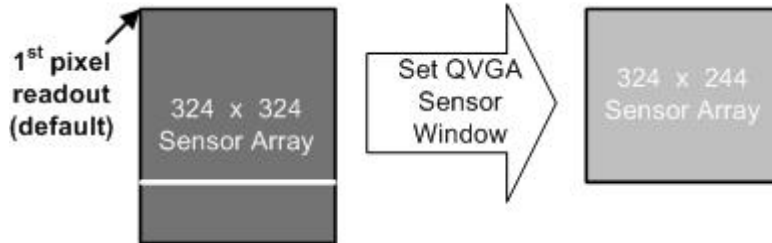

Figure 1.1: QVGA resolution pixel readout

Himax Imaging, Ltd.  
Confidential  
Do Not Copy

## 1.5 Electrical specification

### 1.5.1 Operating ratings

Parameter	Symbol	Spec.			Unit
		Min.	Typ.	Max.	
Analog supply voltage	V <sub>DD-A</sub>	2.6	2.8	3.0	V
IO supply voltage	V <sub>DD-IO</sub>	1.7	1.8	3.0	V

Table 1.1: Operating ratings

### 1.5.2 DC characteristics

The power consumptions are measured in sense (C<sub>L</sub> = 5pF).

Parameter	Symbol	Condition	Spec.			Unit
			Min.	Typ.	Max.	
<b>Average Current Consumption</b>						
Active current 1	I <sub>DD-AVDD1</sub>	External Internal LDO Mode, 8-bit RAW, QVGA @ 60FPS, PCLKO gated, V <sub>DD-A</sub> = 2.8V, V <sub>DD-D</sub> = 1.5V, V <sub>DD-IO</sub> = 1.8V	-	271	-	μA
	I <sub>DD-DVDD1</sub>		-	1201	-	μA
	I <sub>DD-IOVDD1</sub>		-	287	-	μA
Active current 2	I <sub>DD-AVDD2</sub>	Internal LDO Mode, 8-bit RAW, QVGA @ 60FPS, PCLKO gated, V <sub>DD-A</sub> = 2.8V, V <sub>DD-IO</sub> = 2.8V	-	278	-	μA
	I <sub>DD-IOVDD2</sub>		-	1746	-	μA
Standby current 1	I <sub>DD-STANDBY1</sub>	External Internal LDO Mode, V <sub>DD-A</sub> = 2.8V, V <sub>DD-D</sub> = 1.5V, V <sub>DD-IO</sub> = 1.8V, MCLK on	-	105.7	-	μA
Standby current 2	I <sub>DD-STANDBY2</sub>	External Internal LDO Mode, V <sub>DD-A</sub> = 2.8V, V <sub>DD-D</sub> = 1.5V, V <sub>DD-IO</sub> = 1.8V, MCLK off	-	3	-	μA
Standby current 3	I <sub>DD-STANDBY3</sub>	Internal LDO Mode, V <sub>DD-A</sub> = 2.8V, V <sub>DD-IO</sub> = 2.8V, MCLK on	-	142.3	-	μA
Standby current 4	I <sub>DD-STANDBY4</sub>	Internal LDO Mode, V <sub>DD-A</sub> = 2.8V, V <sub>DD-IO</sub> = 2.8V, MCLK off	-	25.1	-	μA
<b>Digital Inputs (MCLK, TRIG, SCL)</b>						
Input voltage low	V <sub>IL</sub>	-	GND – 0.3	-	0.3V <sub>DD-IO</sub>	V
Input voltage high	V <sub>IH</sub>	-	0.7V <sub>DD-IO</sub>	-	V <sub>DD-IO</sub> + 0.3	V
Input capacitance	C <sub>IN</sub>	-		4	-	pF
<b>Digital Output</b>						
Output voltage low	V <sub>OL</sub>	-	-	-	0.2V <sub>DD-IO</sub>	V
Output voltage high	V <sub>OH</sub>	-	0.8V <sub>DD-IO</sub>	-	-	V
Output capacitance	C <sub>OUT</sub>	-	-	4	-	pF
Output resistance	R <sub>OUT</sub>	-	-	1	-	Ω
Tri-state leakage current	I <sub>OZ</sub>	-	-	-	10	μA

Table 1.2: DC characteristics

**1.5.3 Master clock input (MCLK)**

Parameter	Symbol	Condition	Spec.			Unit
			Min.	Typ.	Max.	
Input frequency	MCLK	-	3	-	36	MHz
Input clock duty cycle	MCLK <sub>DUTY</sub>	-	45	-	55	%

**Table 1.3: Master Clock (MCLK) timing**

Himax Imaging, Ltd.  
Confidential  
Do Not Copy

## 1.6 Power up sequence

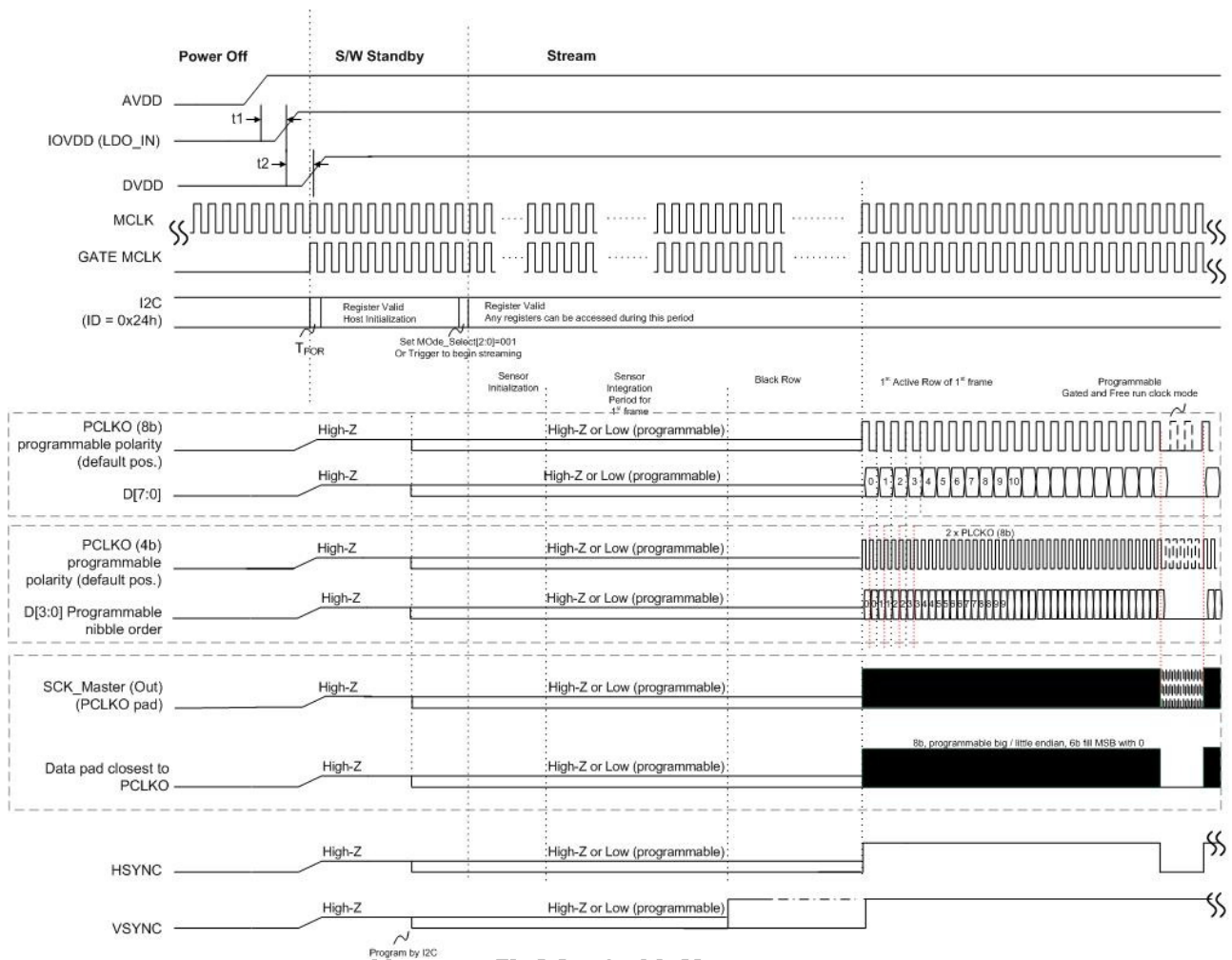

Figure 1.2: Power up sequence

Parameter	Symbol	Spec.			Unit
		Min.	Typ.	Max.	
AVDD to IOVDD	t1	0	-	∞	s
IOVDD to DVDD	t2	0	-	∞	s
Power On Reset time	tPOR	50	-	-	μs

Table 1.4: Power up sequence timing

## 2. Camera Module Specification

### 2.1 Pin map and description of camera module

Pin no.	Pin name	Type	Description
1	NC	-	No connection.
2	GND	Ground	Ground.
3	D1	Out	Data 1 output.
4	AVDD	Power	Analog power. <b>(2.8V)</b>
5	D3	Out	Data 3 output.
6	VSYNC	Out	Frame valid output.
7	TRIG	In	Frame trigger input. <b>(Internal pull down / Active high)</b>
8	MCLK	In	Master clock input.
9	D2	Out	Data 2 output.
10	IOVDD	Power	IO power. <b>(1.8V / 2.8V)</b>
11	AVDD	Power	Analog power. <b>(2.8V)</b>
12	D4	Out	Data 4 output.
13	D7	Out	Data 7 output.
14	D0	Out	Data 0 output.
15	GND	Ground	Ground.
16	HSYNC	Out	Line valid output.
17	PCLKO / SCK	Out	Pixel clock / Serial clock output.
18	INT	Out	Interrupt output. <b>(Active high)</b>
19	D6	Out	Data 6 output.
20	D5	Out	Data 5 output.
21	SCL	In	I2C serial clock.
22	SDA	In/Out	Serial data I/O. <b>(Open drain)</b>
23	NC	-	No Connection
24	NC	-	No Connection

Note: (1) HM01B0 sensor default slave address: 0x24.

**Table 2.1: Pin map and description of camera module**

## 2.2 Mechanical drawing of camera module

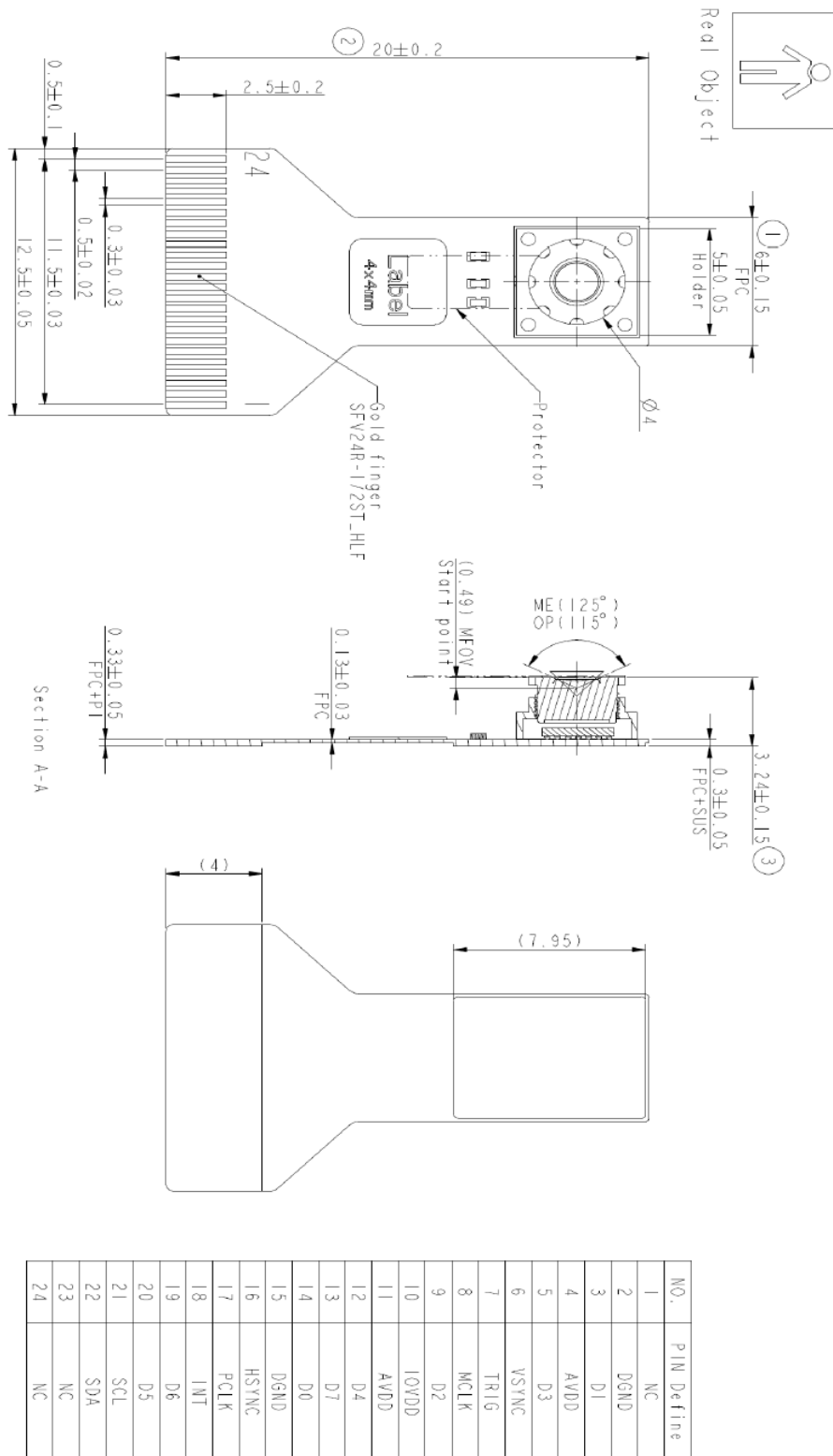

Figure 2.1: Mechanical drawing of camera module

## 2.3 Application schematic of camera module

### 2.3.1 Reference circuit

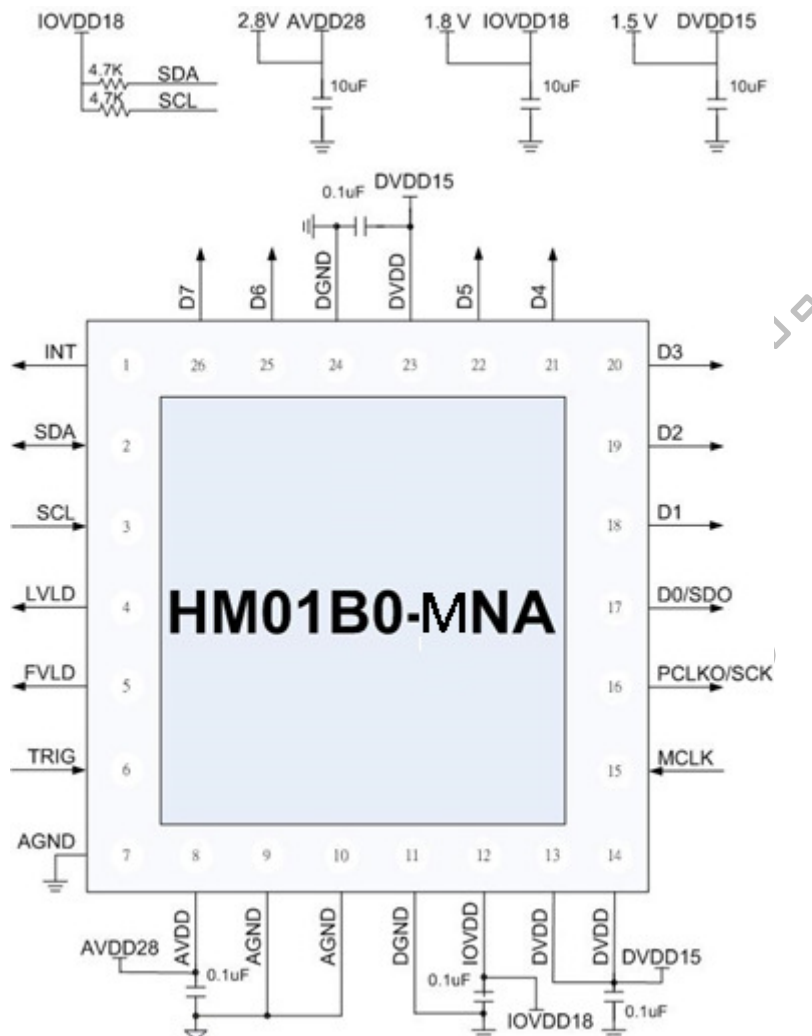

Figure 2.2: Reference circuit of camera module

### 2.3.2 Layout consideration

- In order to reduce power noise to the camera module, it is suggested that a 0.1µF capacitor and a high value decoupling capacitor (**10µF or above**) be placed across every power line (**AVDD & DVDD & IOVDD**) and corresponding ground pin. Try to place these capacitors close to the module connector. The power noise will contribute to image noise and it is necessary to reduce them as much as possible.
- In order to reduce interference and noise caused by the high frequency clocks. It is suggested that the master and pixel clocks be surrounded with ground shielding pins.
- In order to avoid the ground loop, it is recommended that the sensor analog ground be connected to sensor digital ground through a point or 0ohm resistor. Then the sensor digital ground should be connected to system ground through a point or a 0 ohm resistor.
- In order to reduce EM radiation, it is recommended that ground pins be assigned to the edge of the module connector.



### 3. Optical Lens Specification

#### 3.1 Mechanical drawing of optical lens

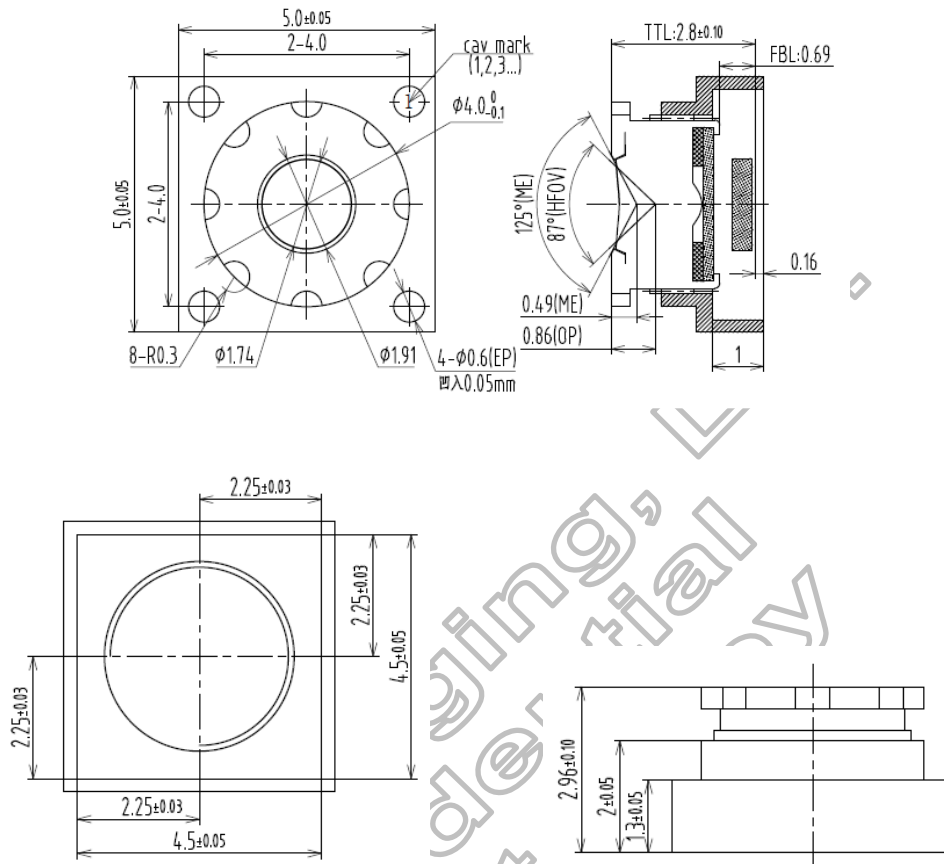

Figure 3.1: Mechanical drawing of optical lens

### 4. Image Quality Specification

No.	Test Item	Diagram	Test Condition	Standard
1	MTF		Test Chart : 1/8 N Pattern Chart Distance : 35cm Full Image Size	Center(0% field) : $\geq 0.8$ Corner(65% field) : $\geq 0.6$
2	Shading	 AOI: 32x32 pixel Shading Ratio= $Y_{corner(min)} / Y_{center}$	Without ISP (raw image) Distance : 1cm Light condition : 1500 +/- 300 lux , 5100+/-300K	$\geq 30\%$
3	Blemish	 A : 324pixel B : 324pixel Block Size : 9x9 pixel	Without ISP (raw image) Distance : 1cm Light condition : 1500 +/- 300 lux , 5100+/-300K	The luminance difference between each block and the adjacent block should be less than 3%
4	Defect pixel	Dark Pixel Defect	The sensor is illuminated to midlevel : $\sim 400$ LSBs to 700 LSBs.	Within a color plane, each pixel is compared to the mean of the neighboring 40 x 40 pixels. If the pixel value is 40 percent or more below the mean, it is considered a dark pixel defect.
		Bright Pixel Defect	The sensor is illuminated to midlevel : $\sim 400$ LSBs to 700 LSBs. (Analog gain = 1; exposure time = 10ms)	Within a color plane, each pixel is compared to the mean of the neighboring 40 x 40 pixels. If the pixel value is 40 percent or more above the mean, it is considered a dark pixel defect.
		Bright Cluster Defect No. : 10	By "Bright Pixel Defect" Result	The defects within each color plane are examined. If any two adjacent pixels that are considered bright pixel defects are detected, they are then defined as a bright cluster.
		Dark Cluster Defect No. : 10	By "Dark Pixel Defect" Result	The defects within a color plane are examined. If any two

			adjacent pixels that are considered dark pixel defects are detected, they are then defined as a dark cluster.
--	--	--	---

Table 4.1: Image Quality Specification

Himax Imaging, Ltd.  
Confidential  
Do Not Copy

## 5. Reliability Test Conditions

### 5.1 Test Unit :

Reliability test Q'ty : 35 pcs

### 5.2 Test Condition

No.	Test Item	Test Conditions	Judgement
1	High Temperature test	60°C / 48 hrs	The difference of MTF(%) Center <=5 Corner(0.7f) <=10
2	High Temperature & Humidity test	60°C / 90%RH 48hrs	
3	Low Temperature test	-20°C / 48 hrs	
4	Thermal Shock test (No-Operating)	-20°C / 30min~60°C / 30min 32 cycles	
5	ESD test (No-Operating)	Contact discharge: ±2.0 KV / 10 times, to USB connector Human Body Mode	
6	Mechanical Vibration test (No-Operating, No packaging)	5Hz~350Hz~500Hz 0.21 Grms. Vibrate X,Y, and Z axis, 60min per axis.	
7	Mechanical Vibration test (No-Operating, packaging)	5Hz~55Hz; -6dB; Acc 3G, Vibrate X,Y, and Z axis, 60min per axis.	
8	Drop test (No-Operating, No packaging)	80cm height free fall for 10 times per unit base material: concrete floor	
9	Drop test (No-Operating, packaging)	100cm height free fall for 10 impacts per unit (1 corner, 3 edges, 6 faces) base material: concrete floor	

Table 5.1: Reliability test condition

## 6. Inspection Specification

### 6.1 Sampling Plan

MIL-STD-105E Level single normal random sampling  
Defect classification and AQL

Category	Dimension, appearance	Image function
AQL	AQL = 0.65	AQL = 0.4

### 6.2 Visual Inspection Method

Lighting : the light level in QC station is 500~800 Lux  
Location : test sample should put in front of inspector for 30cm±5cm  
View angle : 90±15 degree

### 6.3 Inspection Item

Appearance and dimension check  
Image function inspection

### 6.4 Remark

This standard is a general. If any special case (ex; specified component .. etc), it should be created a related standard and keep it was updated. If any Dept. or customer has special request, we will use this request temporarily until it was canceled by Dept. or customer.

### 6.5 Appearance and Dimension Check

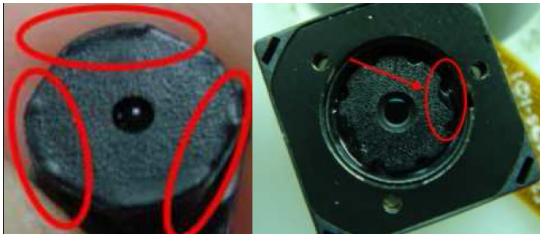
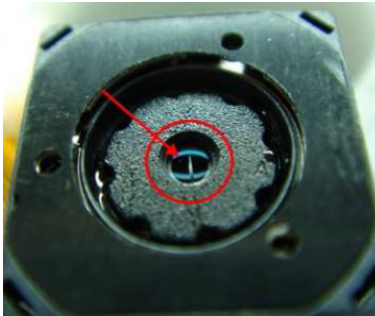
Cate.	No.	Item	Specification	Picture
Product outline	1	Please follow ME drawing	Please reference ME drawing	Please reference ME drawing
Product appearance	1	Lens glue overflow Barrel damaged	1. No protruded glue residue on the Lens/Barrel surface 2. Barrel can be not damaged	This is not the correct model, Only for understanding 
	2	Lens scratch	1. length ≤ 0.5D of lens 2. can be not influence image	This is not the correct model, Only for understanding 
	3	Barrel scatch	1. length ≤ D 2. length ≥ 1/2D	This is not the correct model, Only for understanding

		allow 2 places 3. can't be across center area	
4	FPCA burr	<0.2mm and can't make the outline dimension out of spec.	
5	Barrel loose	Barrel lossed is unacceptable	
6	Holder mount gap	1. can't make the outline dimension out of spec. 2. can't influence image	This is not the correct model, Only for understanding 
7	Solder mask damage	Circuit or inner material exposure is not acceptable	This is not the correct model, Only for understanding 
8	FPC dirty or glue residue	Length ( or 2Radius) of the dirty or glue residue < 1/5 th3 samllest edge length	This is not the correct model, Only for understanding 
9	FPC printing	1. printing missing is NG	This is not the correct model, Only for understanding.

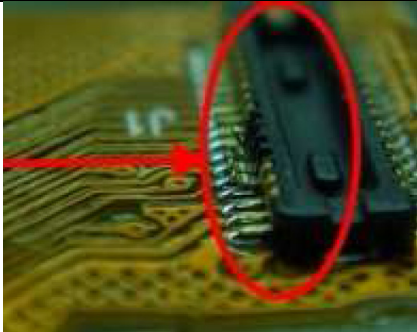
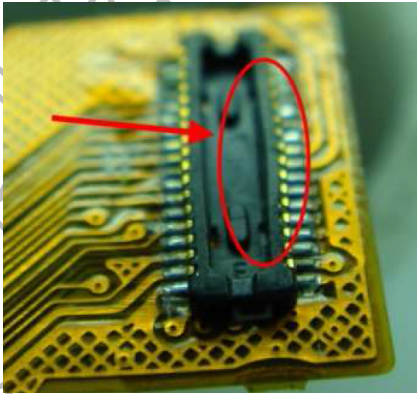
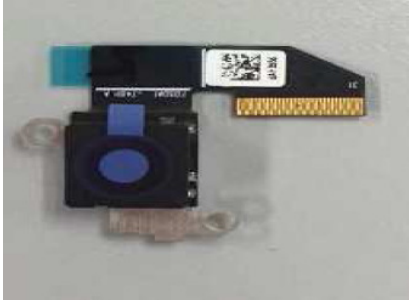
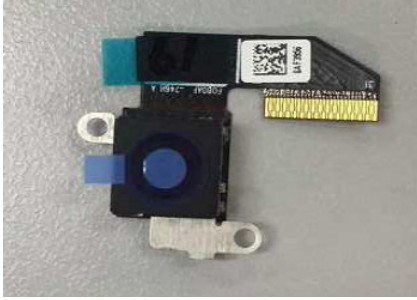

			2. printing should be no blurred	
10	Connector	<ol style="list-style-type: none"> <li>1.No solder ball and no solder residue</li> <li>2. Pin oxidation is not acceptable</li> <li>3. Pin damaged is not acceptable</li> <li>4. Connector deformed and caused image problem is unacceptable</li> </ol>	 	
11	Mylar attached	<ol style="list-style-type: none"> <li>1. Mylar missing is NG</li> <li>2. Mylar should be in the same direction (same as PCB indicator)</li> <li>3. Mylar is allowed to be shifted within a range of 45 degree; however, mylar lift-up is unacceptable</li> </ol>	<p>This is not the correct model, Only for understanding.</p>  	
12	Product label	1. Label missing is NG, should be no	<p>This is not the correct model, Only for understanding.</p>	

			peeling, bubble, or blurred 2. Label is correct and clear and at right location	
Package	1	Packing	1. Quantity check 2. Packing material check 3. Model mixing, material mixing 4. Label is correct and clear and at right location 5. Label should be no peeling, un-complete or blurred	
Function	1	Output	By visual Image not complete or no image is not acceptable	
	2	Abnormal image	By visual Image upside down, abnormal color or apart is unacceptable	
	3	Blurred image	By visual Blurred, shading or other special image is unacceptable	
Image quality	1	Resolution test	By test program Images in center and 4 corners should be clear to identify the lines	
	2	Shading test	By test program Ratio of darkest to center should be great than specified ratio. (without lens correction)	
	3	Blemish	Both visual inspection and test by program are unacceptable	
	4	Defect pixel	Depend on test program judgment	Note: defect pixel definition follow sensor outgoing spec.



## 7. Package Specification

### 7.1 Label List

Item	Label Name	Amount	Position
1	CT Label	1	Top of module
2	QA Label	2	Outside of package box
3	ROHS Label	3	PE BAG and outside of package box
4	Weight Label	3	PE BAG and outside of package box
5	PE Bag Label	2	PE BAG
6	Carton Label	1	Outside of package box

Table 7.1: List of package Label

### 7.2 Packing (the packaging process is only for understanding)

- Put module into the tray, and accumulate trays together and then put an empty tray on the top side as a cap. Tray ties by tape. Put trays & exsiccate into PE Bag.
- Put PE bags put into carton. Stick Logo label and ROHS label on the external box.

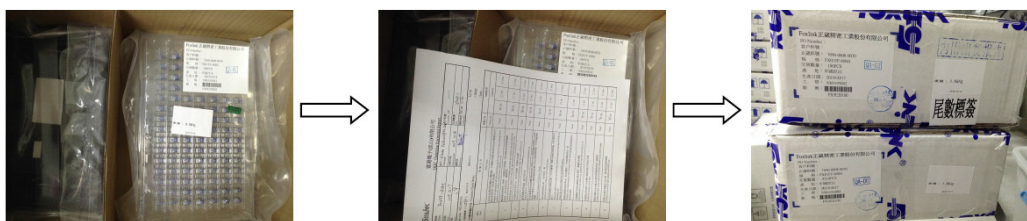

Figure 7.1: Packing of modules

Note:

If the full quantity is not enough to fill in the inner box, the empty tray should be used to fill into the box. No extra space can be in the box to protect the products safety in the transfer process.

### 7.3 Carton Packing Drawing

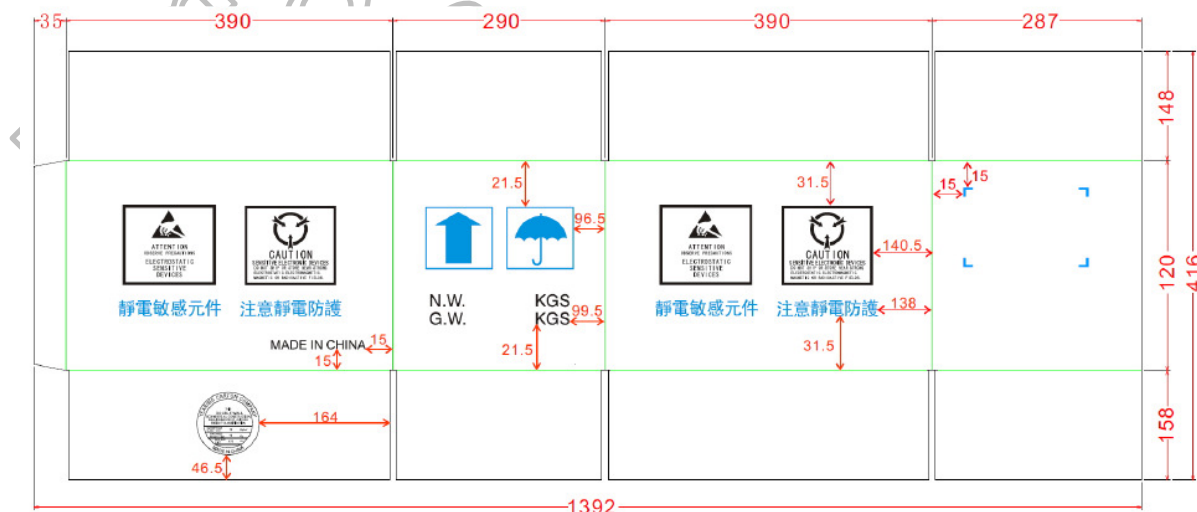

Figure 7.2: Carton packing drawing

## X-ON Electronics

Largest Supplier of Electrical and Electronic Components

*Click to view similar products for [Camera Development Tools](#) category:*

*Click to view products by [SparkFun](#) manufacturer:*

Other Similar products are found below :

[P0447](#) [1937](#) [MXOV10635-S32V](#) [OV10640CSP-S32V](#) [SEN0173](#) [DS90UB953-Q1EVM](#) [3508](#) [3538](#) [EP-DCOV2735-F36](#) [3100](#) [3202](#) [3622](#)  
[397](#) [4407](#) [4469](#) [4959](#) [108024](#) [108025](#) [108226](#) [108225](#) [108320](#) [108328](#) [108329](#) [DFR0498](#) [DFR0620](#) [ESP-EYE](#) [030-0276-0101\\_A](#) [QC-DB-](#)  
[U10006](#) [DP-VIP-I-EVN](#) [USB3-VIP-EVN](#) [CS-DEPTHAI-05](#) [CS-DEPTHAI-06](#) [MCIMXCAMERA1MP](#) [MINISASTOCSI](#)  
[MX8XMIPI4CAM2](#) [PIM365](#) [PIM366](#) [S32V-SONYCAM](#) [110991190](#) [114991702](#) [114992261](#) [114992262](#) [114992263](#) [114992264](#)  
[114992265](#) [CXD5602PWBCAM1\\_FG\\_875607605\\_P](#) [CXD5602PWBCAM1C\\_FG\\_875607606\\_P](#) [CXD5602PWBCAM1E\\_FG\\_875607607\\_P](#)  
[SEN-15570](#) [STPI2-CAMKIT-01](#)