



SPF15N65T1T1TL

650V /15A Trench Field Stop IGBT

Features

- Max Junction Temperature 150°C
- High breakdown voltage up to 650V for improved reliability
- Short Circuit Rated
- Very Low Saturation Voltage:
 $V_{CE(SAT)} = 1.65V$ (Typ.) @ $I_C = 15A$
- Soft current turn-off waveforms

V_{CE}	650	V
I_C	15	A
$V_{CE(SAT)}$ $I_C=15A$	1.65	V

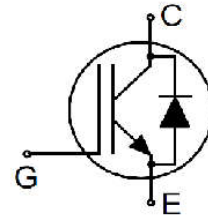

Applications

- Soft switching applications
- Air conditioning
- Motor drive inverter

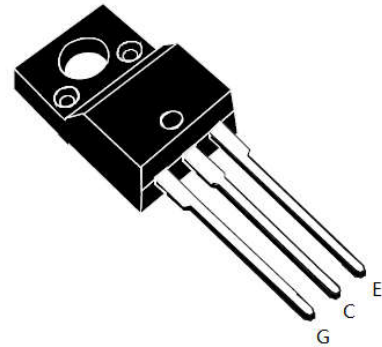

Ordering Information

Product	Package	Packaging
SPF15N65T1T1TL	TO-220F	Tube



Maximum Ratings (T_j= 25°C unless otherwise specified)

Parameter	Symbol	Value	Unit
Collector-Emitter Breakdown Voltage	V _{CE}	650	V
DC collector current, limited by T _{jmax} T _C = 25°C T _C = 100°C	I _C	30 15	A
Diode Forward current, limited by T _{jmax} T _C = 25°C T _C = 100°C	I _F	30 15	A
Continuous Gate-emitter voltage	V _{GE}	±20	V
Transient Gate-emitter voltage	V _{GE}	±30	V
Turn off safe operating area V _{CE} ≤ 650V, T _j ≤ 150°C	-	60	A
Pulsed collector current, V _{GE} =15V, t _p limited by T _{jmax}	I _{CM}	45	A
Short Circuit Withstand Time, V _{GE} = 15V, V _{CE} ≤ 400V	T _{sc}	5	µs
Power dissipation , T _j =25°C	P _{tot}	27	W
Operating junction temperature	T _j	-40...+150	°C
Storage temperature	T _s	-55...+150	°C
Soldering temperature, wave soldering 1.6mm (0.063in.) from case for 10s	-	260	°C

Thermal Resistance

Parameter	Symbol	Max. Value	Unit
IGBT thermal resistance, junction - case	R _{θ(j-c)}	4.9	K/W
Diode thermal resistance, junction - case	R _{θ(j-c)}	5.8	K/W
Thermal resistance, junction - ambient	R _{θ(j-a)}	62.5	K/W



Electrical Characteristics of the IGBT ($T_j = 25^\circ\text{C}$ unless otherwise specified)

Symbol	Parameter	Test Conditions	Min.	Typ.	Max.	Units
Static Characteristics (Tested on wafers)						
BV_{CES}	Collector to Emitter Breakdown Voltage	$V_{GE} = 0V, I_C = 1mA$	650	-	-	V
$V_{CE(SAT)}$	Collector to Emitter Saturation Voltage	$I_C = 15A, V_{GE} = 15V$	-	1.65	1.95	V
$V_{GE(th)}$	G-E Threshold Voltage	$V_{GE} = V_{CE}, I_C = 250\mu A$	4.1	5.0	5.7	V
I_{CES}	Collector Cut-Off Current	$V_{CE} = 650V, V_{GE} = 0V$	-	-	10	μA
I_{GES}	G-E Leakage Current	$V_{GE} = \pm 20V, V_{CE} = 0V$	-	-	± 200	nA
g_{fs}	Transconductance	$V_{CE}=20V, I_C=15A$	-	10	-	S

Parameter	Symbol	Conditions	Min	Typ	Max	Unit
Dynamic						
Input capacitance	C_{ies}	$V_{CE} = 25V, V_{GE} = 0V,$ $f = 1MHz$	-	1910	-	pF
Output capacitance	C_{oes}		-	80	-	
Reverse transfer capacitance	C_{res}		-	46	-	
Gate charge	Q_G	$V_{CC} = 480V, I_C = 15A,$ $V_{GE} = 15V$	-	92	-	nC
Short circuit collector current	$I_{C(SC)}$	$V_{GE}=15V, t_{SC} \leq 5\mu s$ $V_{CC}=400V,$ $T_{j, start}=25^\circ C$	-	98	-	A



Switching Characteristic, Inductive Load (T_j= 25°C unless otherwise specified)

Parameter	Symbol	Conditions	Min.	Typ.	Max.	Unit
Dynamic						
Turn-on Delay Time	t _{d(on)}	T _j =25°C V _{CC} = 400V, I _C = 15A, V _{GE} = 0/15V, R _g =12Ω	-	15	-	ns
Rise Time	t _r		-	25	-	ns
Turn-off Delay Time	t _{d(off)}		-	60	-	ns
Fall Time	t _f		-	46	-	ns
Turn-on Energy	E _{on}		-	0.75	-	mJ
Turn-off Energy	E _{off}		-	0.1	-	mJ

Electrical Characteristics of the DIODE (T_j= 25°C unless otherwise specified)

Parameter	Symbol	Conditions	Min	Typ	Max	Unit
Dynamic						
Diode Forward Voltage	V _{FM}	I _F = 15A	-	1.7	-	V
Reverse Recovery Time	T _{rr}	I _F = 15A VR = 300V, di/dt =200A/μs	-	50	-	ns
Reverse Recovery Current	I _{rr}		-	4	-	A
Reverse Recovery Charge	Q _{rr}		-	83	-	nC

Fig. 1 FBSOA characteristics

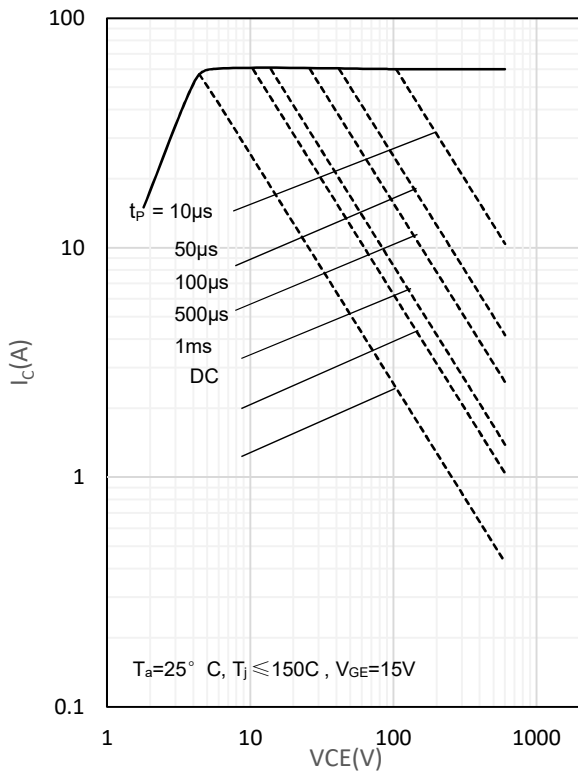

Fig. 2 Load Current vs. Frequency

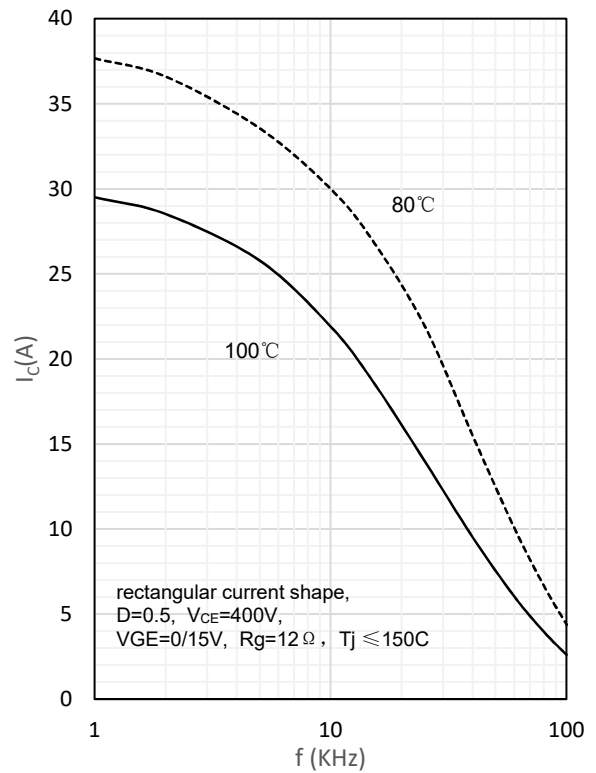

Fig. 3 Output characteristics

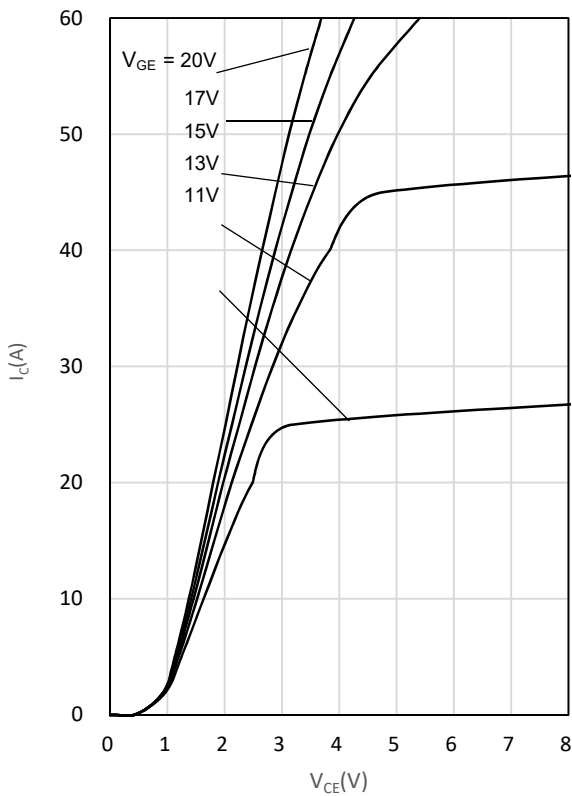

Fig. 4 Saturation voltage characteristics

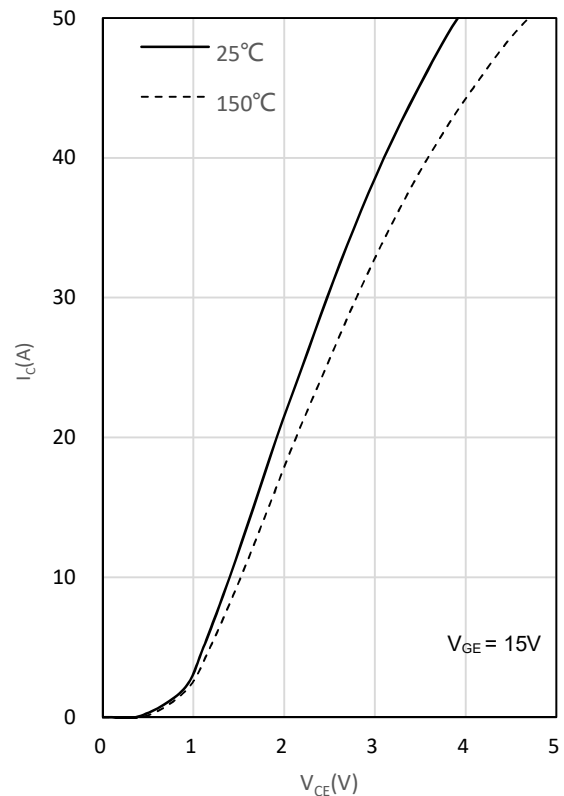

Fig. 5 Switching times vs. gate resistor

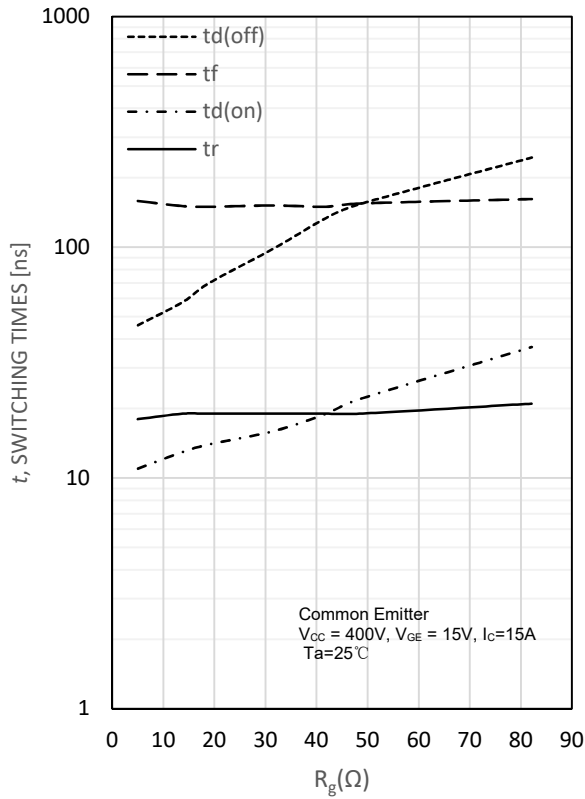

Fig. 6 Switching times vs. collector current

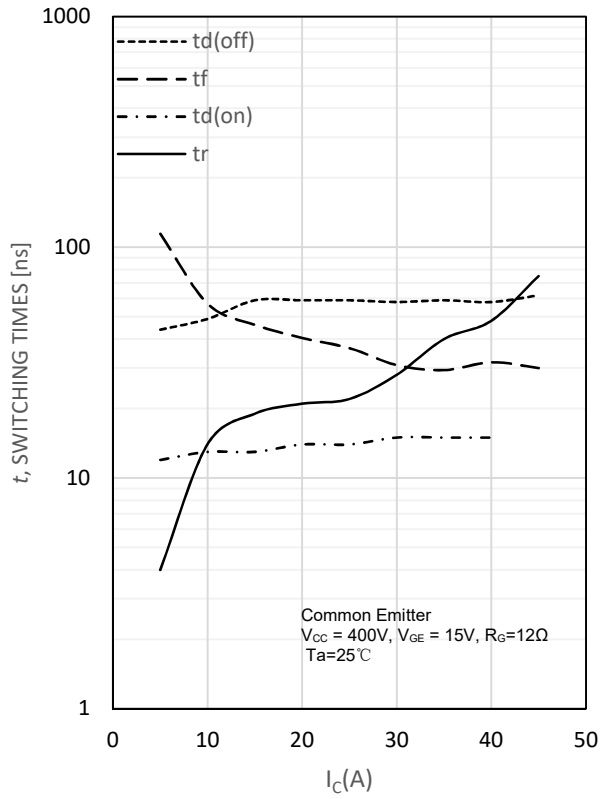

Fig. 7 Switching loss vs. gate resistor

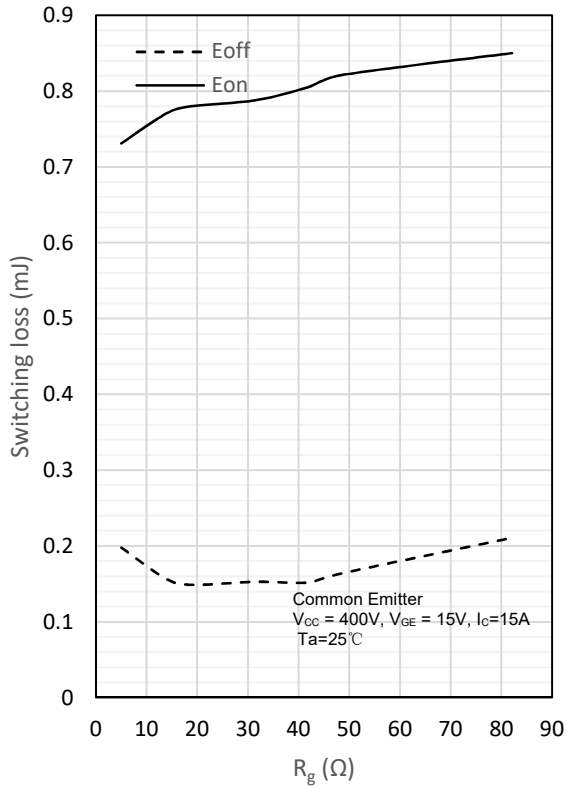

Fig. 8 Switching loss vs. collector current

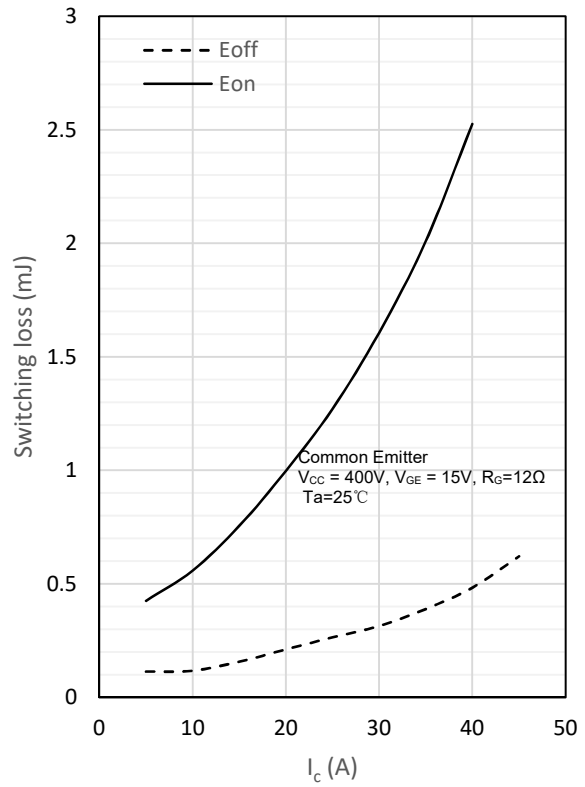

Fig. 9 Gate charge characteristics

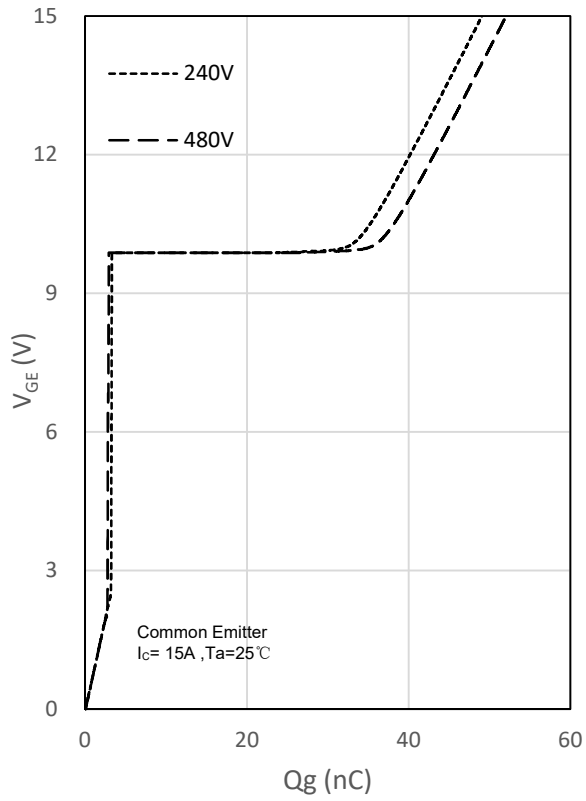
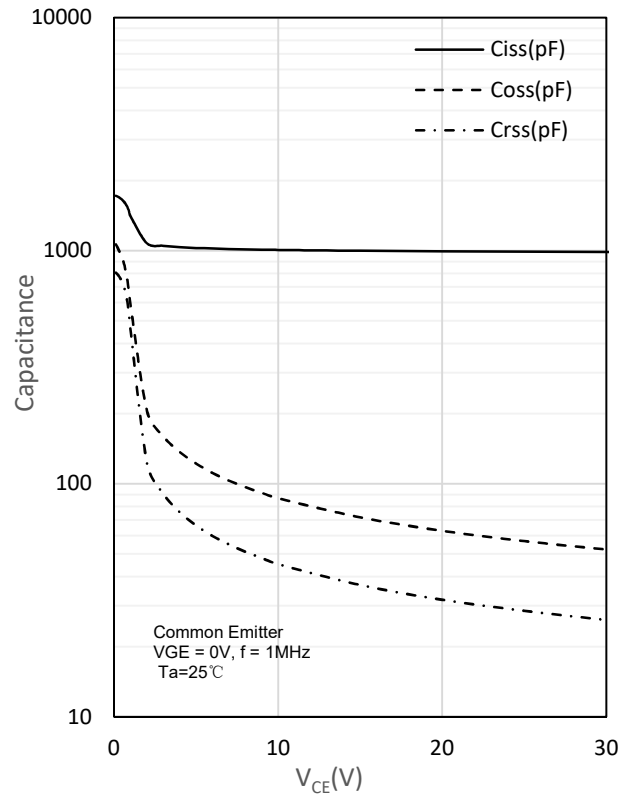
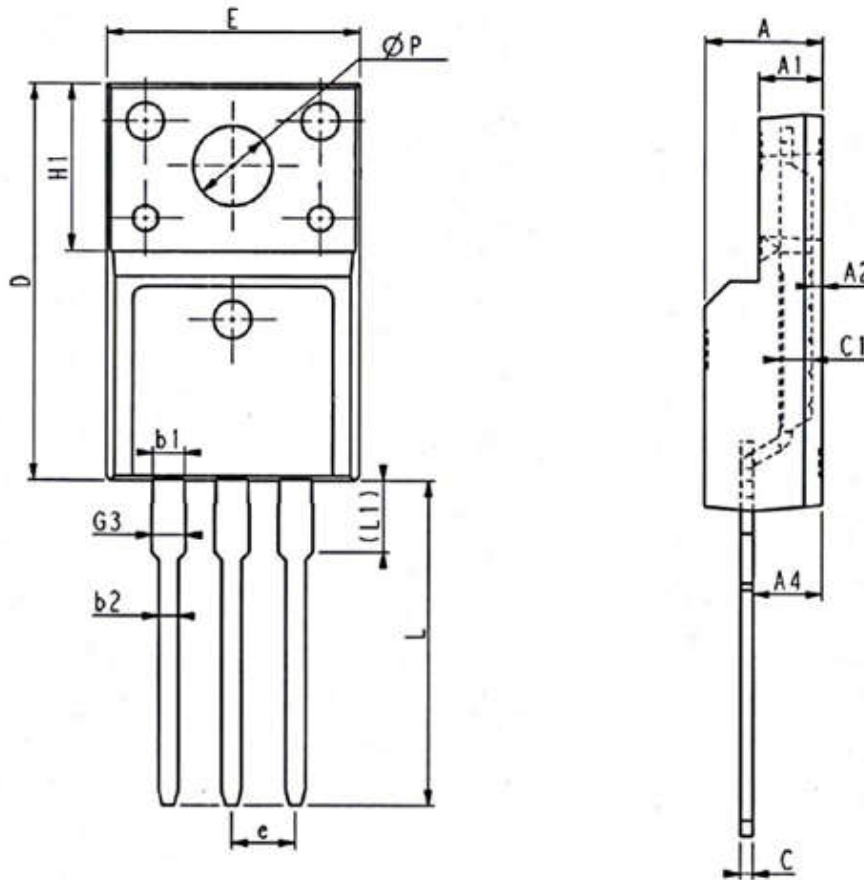

Fig. 10 Capacitance characteristics



TO-220MF package information



SYMBOL	MIN	NOM	MAX
	E	9.96	10.16
A	4.50	4.70	4.90
A1	2.34	2.54	2.74
A2	0.30	0.45	0.60
A4	2.56	2.76	2.96
c	0.40	0.50	0.65
c1	1.20	1.30	1.35
D	15.57	15.87	16.17
H1	6.70REF		
e	2.54BSC		
L	12.68	12.98	13.28
L1	2.88	3.03	3.18
ΦP	3.03	3.18	3.38
$\Phi P3$	3.15	3.45	3.65
F3	3.15	3.30	3.45
G3	1.25	1.35	1.55
b1	1.18	1.28	1.43
b2	0.70	0.80	0.95

X-ON Electronics

Largest Supplier of Electrical and Electronic Components

Click to view similar products for [IGBT Transistors category](#):

Click to view products by [SPS manufacturer](#):

Other Similar products are found below :

[748152A](#) [FGH60T65SHD_F155](#) [APT100GT60B2RG](#) [APT13GP120BG](#) [APT20GN60BG](#) [APT20GT60BRDQ1G](#) [APT25GN120B2DQ2G](#)
[APT35GA90BD15](#) [APT36GA60BD15](#) [APT40GP60B2DQ2G](#) [APT40GP90B2DQ2G](#) [APT50GN120B2G](#) [APT50GT60BRG](#)
[APT64GA90B2D30](#) [APT70GR120J](#) [NGTB10N60FG](#) [NGTB30N60L2WG](#) [IGP30N60H3XKSA1](#) [STGB15H60DF](#) [STGFW20V60DF](#)
[STGFW30V60DF](#) [STGFW40V60F](#) [STGWA25H120DF2](#) [FGB3236_F085](#) [APT25GN120BG](#) [APT25GR120S](#) [APT30GN60BDQ2G](#)
[APT30GN60BG](#) [APT30GP60BG](#) [APT30GS60BRDQ2G](#) [APT30N60BC6](#) [APT35GP120JDQ2](#) [APT36GA60B](#) [APT45GR65B2DU30](#)
[APT50GP60B2DQ2G](#) [APT68GA60B](#) [APT70GR65B](#) [APT70GR65B2SCD30](#) [GT50JR22\(STA1ES\)](#) [TIG058E8-TL-H](#) [IDW40E65D2](#)
[SGB15N120ATMA1](#) [NGTB50N60L2WG](#) [STGB10H60DF](#) [STGB20V60F](#) [STGB40V60F](#) [STGFW80V60F](#) [IGW40N120H3FKSA1](#)
[RJH60D7BDPQ-E0#T2](#) [APT40GR120B](#)