

650V /60A Trench Field Stop IGBT

650V Trench Field Stop IGBTs offer low switching losses, high energy efficiency and high avalanche ruggedness for motion control, solar application and welding machine.

V_{CE}	650	V
I_C	60	A
$V_{CE(SAT)} I_C=60A$	1.85	V

FEATURES

- High breakdown voltage up to 650V for improved reliability
- Trench-Stop Technology offering :
 - High speed switching
 - High ruggedness, temperature stable
 - Low V_{CEsat}
 - Easy parallel switching capability due to positive temperature coefficient in V_{CEsat}
- Enhanced avalanche capability

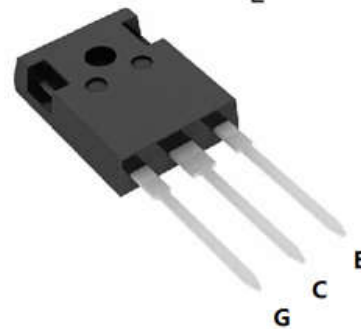
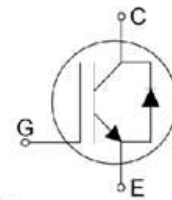

APPLICATION

- Uninterruptible Power Supplies
- Inverter
- Welding Converters
- PFC applications
- Converter with high switching frequency

Ordering Information

Product	Package	Packaging
SPT60N65F1A1T8TL	TO-247	Tube



Maximum Ratings (T_j= 25°C unless otherwise specified)

Parameter	Symbol	Value	Unit
Collector-Emitter Breakdown Voltage	V _{CE}	650	V
DC collector current, limited by T _{jmax} T _C = 25°C T _C = 100°C	I _C	120 60	A
Diode Forward current, limited by T _{jmax} T _C = 25°C T _C = 100°C	I _F	120 60	A
Continuous Gate-emitter voltage	V _{GE}	±20	V
Transient Gate-emitter voltage	V _{GE}	±30	V
Turn off safe operating area V _{CE} ≤ 650V, T _j ≤ 150°C	-	180	A
Pulse collector current, V _{GE} = 15V, t _p limited by T _{jmax}	I _{CM}	180	A
Power dissipation , T _j =25°C	P _{tot}	260	W
Operating junction temperature	T _j	-40...+150	°C
Storage temperature	T _s	-55...+150	°C
Soldering temperature, wave soldering 1.6mm (0.063in.) from case for 10s	-	260	°C

Thermal Resistance

Parameter	Symbol	Max. Value	Unit
IGBT thermal resistance, junction - case	R _{θ(j-c)}	0.48	K/W
Diode thermal resistance, junction - case	R _{θ(j-c)}	1.1	K/W
Thermal resistance, junction - ambient	R _{θ(j-a)}	40	K/W

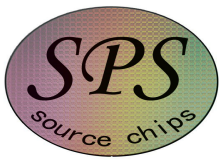

Electrical Characteristics (T_j = 25°C unless otherwise specified)

Parameter	Symbol	Conditions	Min	Typ	Max	Unit
Static						
Collector-Emitter Breakdown Voltage	BV _{CES}	V _{GE} =0V, I _C =250uA	650		-	V
		V _{GE} =0V, I _C =1mA	650			V
Gate Threshold Voltage	V _{GE(th)}	V _{GE} =V _{CE} , I _C =250uA	4.0	5.0	6.0	V
Collector-Emitter Saturation Voltage	V _{CE(sat)}	V _{GE} =15V, I _C =60A	-	1.85	2.2	V
		T _j = 25°C T _j = 150°C	-	2.25		V
Zero gate voltage collector current	I _{CES}	V _{CE} = 650V, V _{GE} = 0V T _j = 25°C T _j = 150°C		0.1	40 1000	μA
Gate-emitter leakage current	I _{GES}	V _{CE} = 0V, V _{GE} = ±20V			100	nA
Transconductance	g _{fs}	V _{CE} = 20V, I _C = 60A	-	52	-	S

Parameter	Symbol	Conditions	Min	Typ	Max	Unit
Dynamic						
Input capacitance	C _{ies}	V _{CE} = 30V, V _{GE} = 0V, f = 1MHz		3800		pF
Output capacitance	C _{oes}			130		
Reverse transfer capacitance	C _{res}			70		
Gate charge	Q _G	V _{CC} = 520V, I _C = 60A, V _{GE} = 15V	-	158	-	nC



Switching Characteristic, Inductive Load

Parameter	Symbol	Conditions	Min	Typ	Max	Unit
Dynamic $T_j=25^\circ\text{C}$						
Turn-on Delay Time	$t_{d(on)}$	$V_{CC} = 400\text{V}, I_C = 60.0\text{A},$ $V_{GE} = 0.0/15.0\text{V},$ $R_g=12\Omega$	-	56	-	ns
Rise Time	t_r		-	79	-	ns
Turn-off Delay Time	$t_{d(off)}$		-	165	-	ns
Fall Time	t_f		-	81	-	ns
Turn-on Energy	E_{on}		-	2.2	-	mJ
Turn-off Energy	E_{off}		-	0.89	-	mJ

Electrical Characteristics of the DIODE ($T_j=25^\circ\text{C}$ unless otherwise specified)

Parameter	Symbol	Conditions	Min	Typ	Max	Unit
Dynamic						
Diode Forward Voltage	V_{FM}	$I_F = 60\text{A}$	-	2.9	-	v
Reverse Recovery Time	T_{rr}	$I_F=40\text{A},$ $V_R=300\text{V},$ $di/dt=600\text{A}/\mu\text{s},$	-	90	-	ns
Reverse Recovery Current	I_{rr}		-	17	-	A
Reverse Recovery Charge	Q_{rr}		-	900	-	nC

Fig. 1 FBSOA characteristics

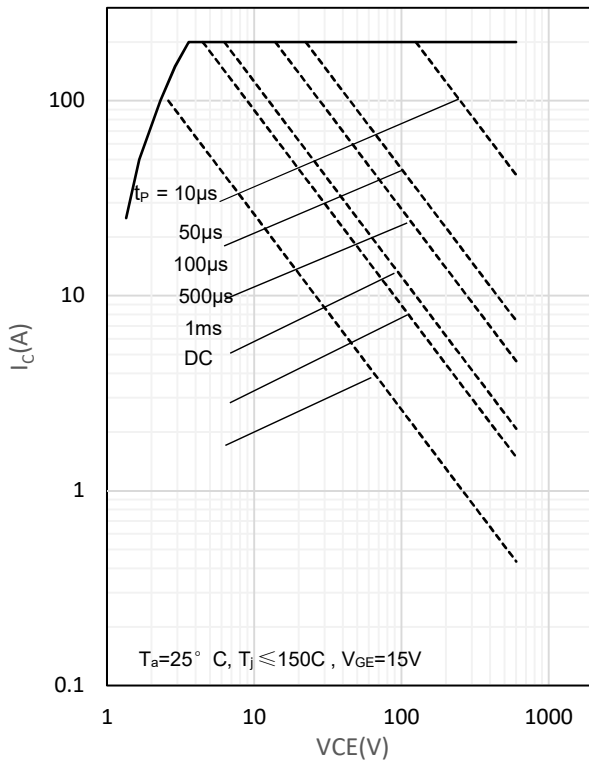

Fig. 2 Power dissipation as a function of T_c

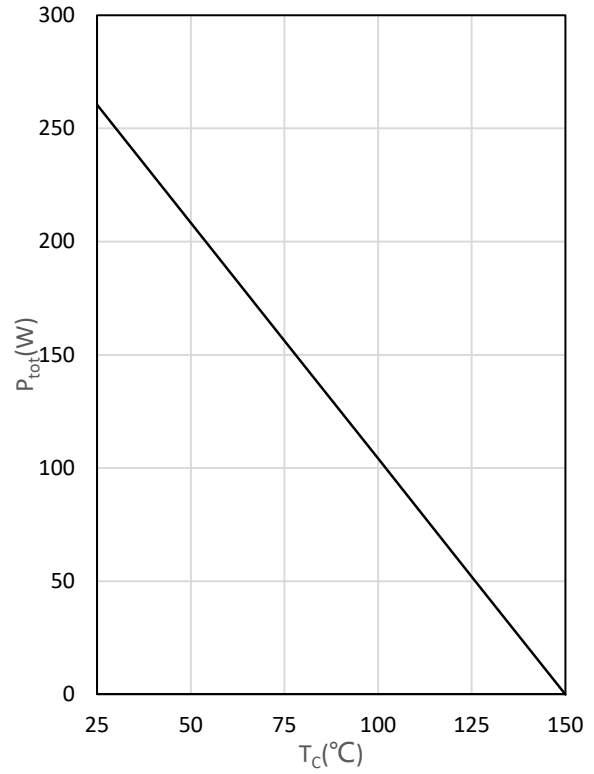

Fig. 3 Output characteristics

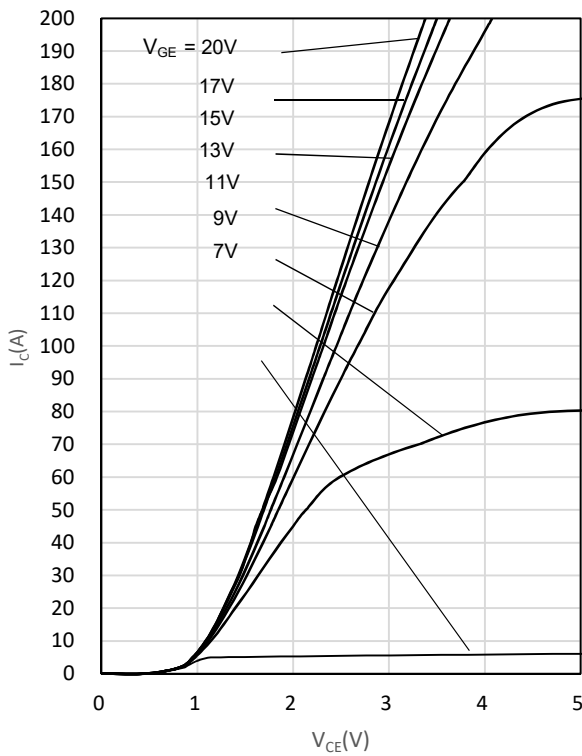

Fig. 4 Saturation voltage characteristics

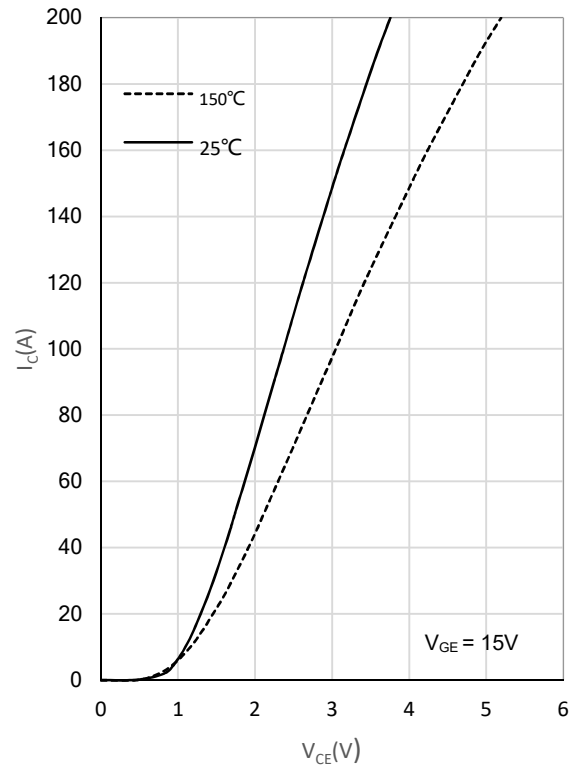

Fig. 5 Switching times vs. gate resistor

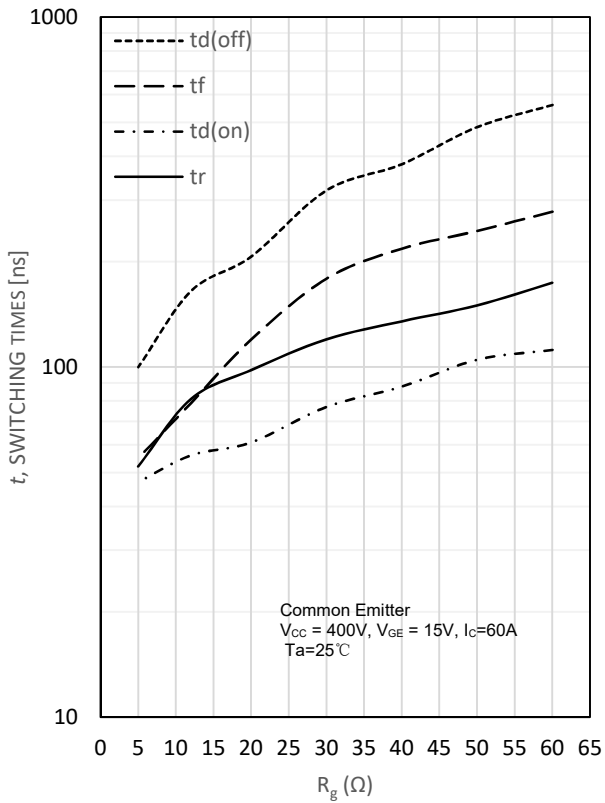

Fig. 6 Switching times vs. collector current

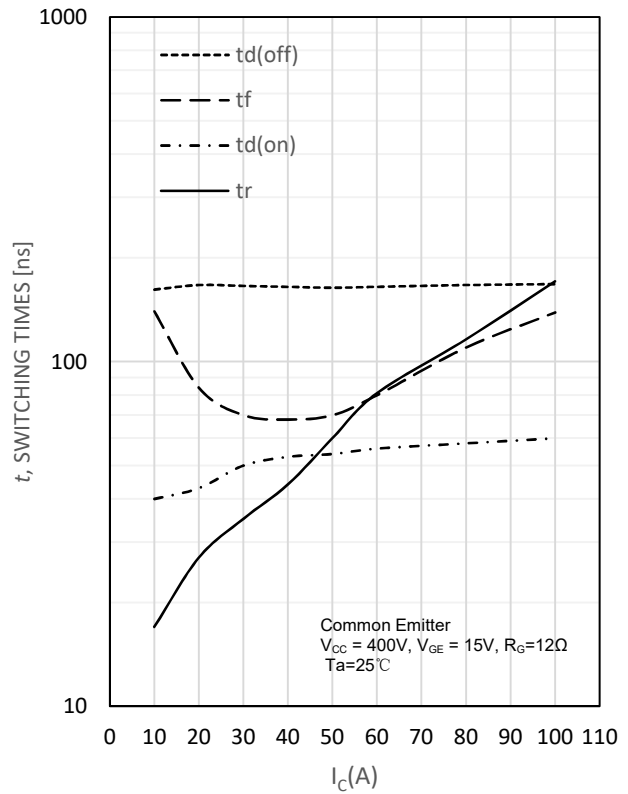

Fig. 7 Switching loss vs. gate resistor

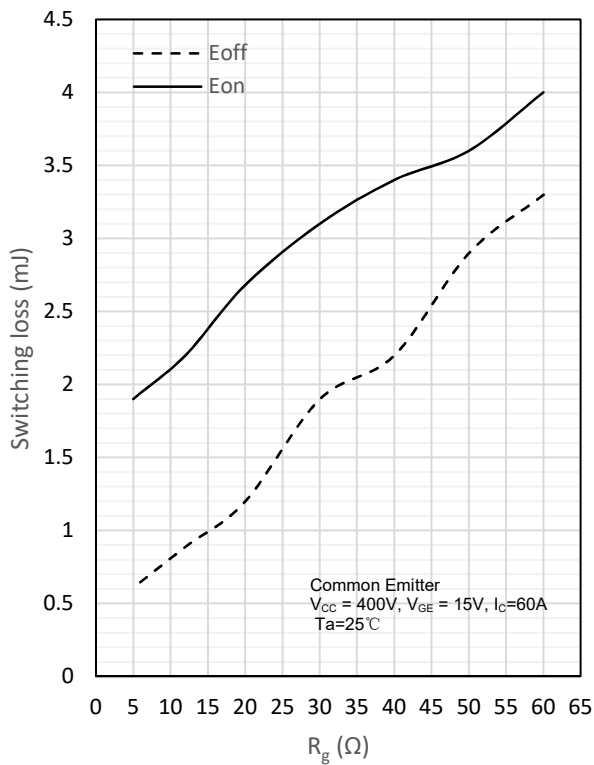

Fig. 8 Switching loss vs. collector current

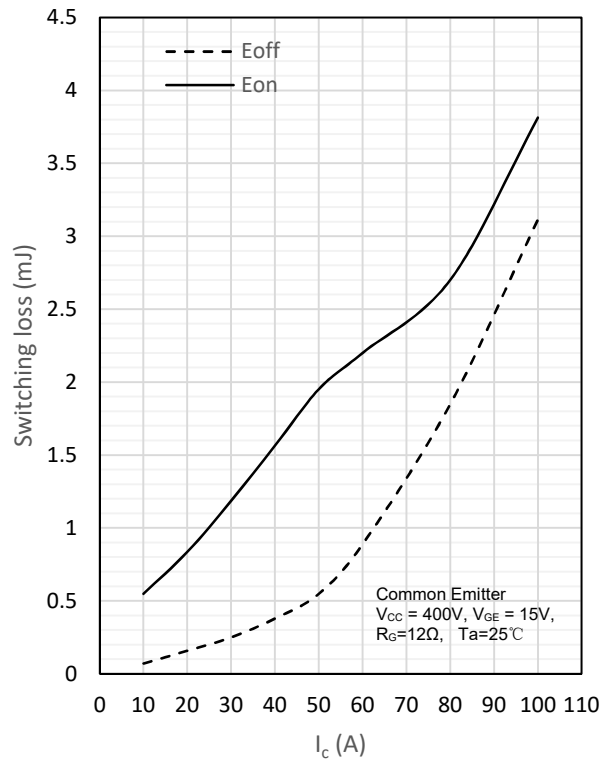

Fig. 9 Gate charge characteristics

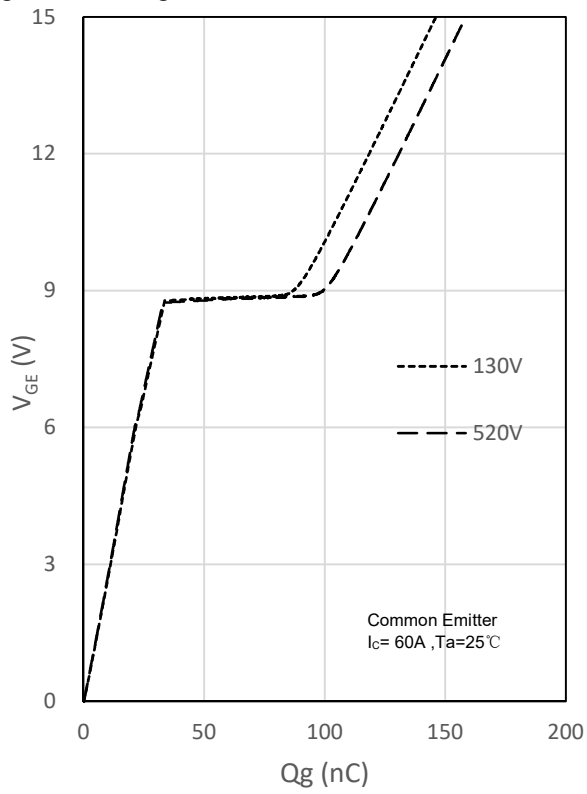
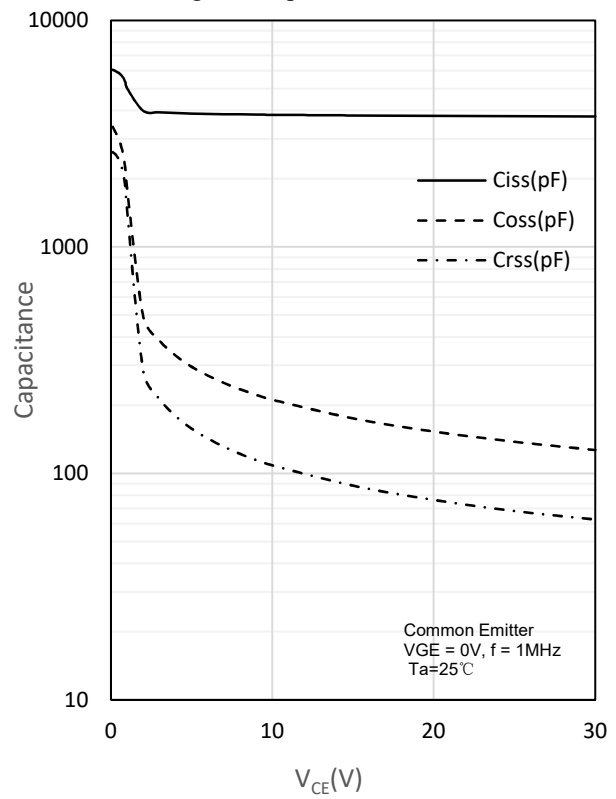
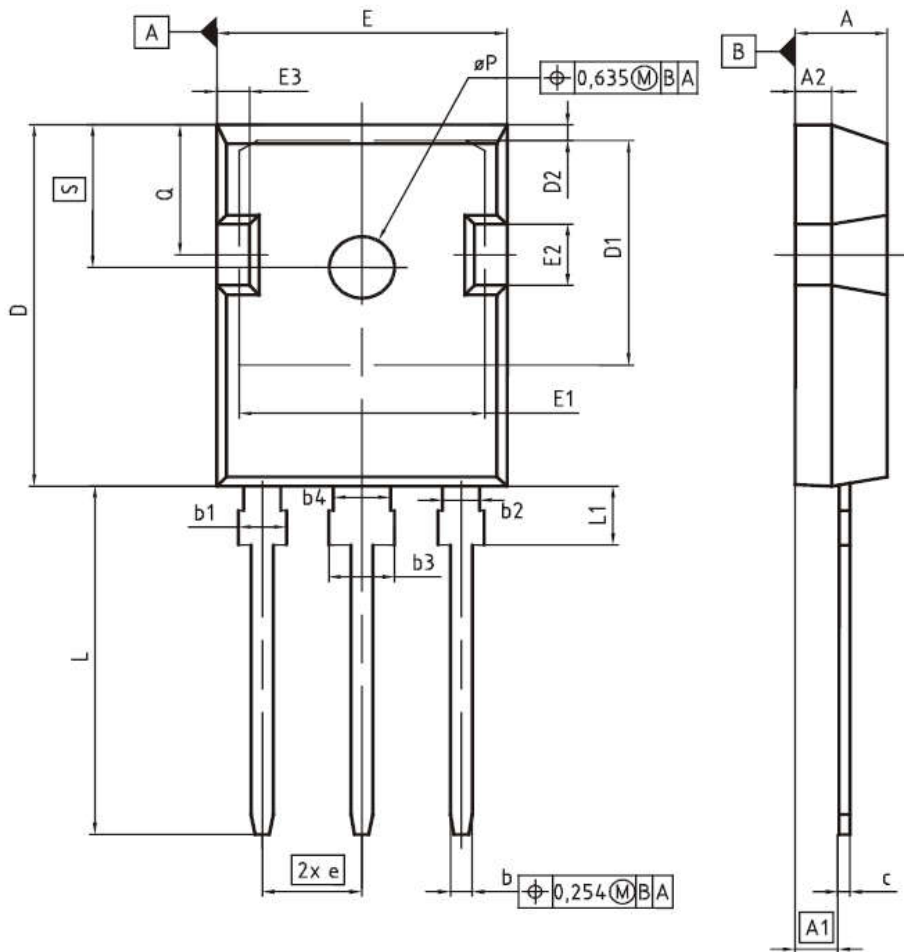

Fig. 10 Capacitance characteristics



PG-TO247-3



DIM	MILLIMETERS		INCHES	
	MIN	MAX	MIN	MAX
A	4.83	5.21	0.190	0.205
A1	2.27	2.54	0.089	0.100
A2	1.85	2.16	0.073	0.085
b	1.07	1.33	0.042	0.052
b1	1.90	2.41	0.075	0.095
b2	1.90	2.16	0.075	0.085
b3	2.87	3.38	0.113	0.133
b4	2.87	3.13	0.113	0.123
c	0.55	0.68	0.022	0.027
D	20.80	21.10	0.819	0.831
D1	16.25	17.65	0.640	0.695
D2	0.95	1.35	0.037	0.053
E	15.70	16.13	0.618	0.635
E1	13.10	14.15	0.516	0.557
E2	3.68	5.10	0.145	0.201
E3	1.00	2.60	0.039	0.102
e	5.44 (BSC)		0.214 (BSC)	
N	3		3	
L	19.80	20.32	0.780	0.800
L1	4.10	4.47	0.161	0.176
øP	3.50	3.70	0.138	0.146
Q	5.49	6.00	0.216	0.236
S	6.04	6.30	0.238	0.248

X-ON Electronics

Largest Supplier of Electrical and Electronic Components

Click to view similar products for [IGBT Transistors category](#):

Click to view products by [SPS manufacturer](#):

Other Similar products are found below :

[748152A](#) [FGH60T65SHD_F155](#) [APT100GT60B2RG](#) [APT13GP120BG](#) [APT20GN60BG](#) [APT20GT60BRDQ1G](#) [APT25GN120B2DQ2G](#)
[APT35GA90BD15](#) [APT36GA60BD15](#) [APT40GP60B2DQ2G](#) [APT40GP90B2DQ2G](#) [APT50GN120B2G](#) [APT50GT60BRG](#)
[APT64GA90B2D30](#) [APT70GR120J](#) [NGTB10N60FG](#) [NGTB30N60L2WG](#) [IGP30N60H3XKSA1](#) [STGB15H60DF](#) [STGFW20V60DF](#)
[STGFW30V60DF](#) [STGFW40V60F](#) [STGWA25H120DF2](#) [FGB3236_F085](#) [APT25GN120BG](#) [APT25GR120S](#) [APT30GN60BDQ2G](#)
[APT30GN60BG](#) [APT30GP60BG](#) [APT30GS60BRDQ2G](#) [APT30N60BC6](#) [APT35GP120JDQ2](#) [APT36GA60B](#) [APT45GR65B2DU30](#)
[APT50GP60B2DQ2G](#) [APT68GA60B](#) [APT70GR65B](#) [APT70GR65B2SCD30](#) [GT50JR22\(STA1ES\)](#) [TIG058E8-TL-H](#) [IDW40E65D2](#)
[SGB15N120ATMA1](#) [NGTB50N60L2WG](#) [STGB10H60DF](#) [STGB20V60F](#) [STGB40V60F](#) [STGFW80V60F](#) [IGW40N120H3FKSA1](#)
[RJH60D7BDPQ-E0#T2](#) [APT40GR120B](#)