



**SPTECH**

深圳市质超微电子有限公司

# SPT60N65F1A1

**650V /60A Trench Field Stop IGBT**

650V Trench Field Stop IGBTs offer low switching losses, high energy efficiency and high avalanche ruggedness for motion control, solar application and welding machine.

$V_{CE}$	<b>650</b>	<b>V</b>
$I_C$	<b>60</b>	<b>A</b>
$V_{CE(SAT)} I_C=60A$	<b>1.85</b>	<b>V</b>

## FEATURES

- High breakdown voltage up to 650V for improved reliability
- Trench-Stop Technology offering :
  - High speed switching
  - High ruggedness, temperature stable
  - Low  $V_{CEsat}$
  - Easy parallel switching capability due to positive temperature coefficient in  $V_{CEsat}$
- Enhanced avalanche capability

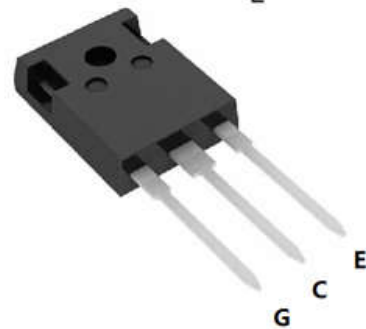
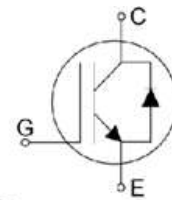

## APPLICATION

- Uninterruptible Power Supplies
- Inverter
- Welding Converters
- PFC applications
- Converter with high switching frequency

Product	Package	Packaging
SPT 60N65F1A1	TO247	Tube



## Maximum Ratings (T<sub>j</sub>= 25°C unless otherwise specified)

Parameter	Symbol	Value	Unit
Collector-Emitter Breakdown Voltage	V <sub>CE</sub>	650	V
DC collector current, limited by T <sub>jmax</sub> T <sub>C</sub> = 25°C T <sub>C</sub> = 100°C	I <sub>C</sub>	120 60	A
Diode Forward current, limited by T <sub>jmax</sub> T <sub>C</sub> = 25°C T <sub>C</sub> = 100°C	I <sub>F</sub>	120 60	A
Continuous Gate-emitter voltage	V <sub>GE</sub>	±20	V
Transient Gate-emitter voltage	V <sub>GE</sub>	±30	V
Turn off safe operating area V <sub>CE</sub> ≤ 650V, T <sub>j</sub> ≤ 150°C	-	180	A
Pulse collector current, V <sub>GE</sub> = 15V, t <sub>p</sub> limited by T <sub>jmax</sub>	I <sub>CM</sub>	180	A
Power dissipation , T <sub>j</sub> =25°C	P <sub>tot</sub>	260	W
Operating junction temperature	T <sub>j</sub>	-40...+150	°C
Storage temperature	T <sub>s</sub>	-55...+150	°C
Soldering temperature, wave soldering 1.6mm (0.063in.) from case for 10s	-	260	°C

## Thermal Resistance

Parameter	Symbol	Max. Value	Unit
IGBT thermal resistance, junction - case	R <sub>θ(j-c)</sub>	0.48	K/W
Diode thermal resistance, junction - case	R <sub>θ(j-c)</sub>	1.1	K/W
Thermal resistance, junction - ambient	R <sub>θ(j-a)</sub>	40	K/W



## Electrical Characteristics (T<sub>j</sub>= 25°C unless otherwise specified)

Parameter	Symbol	Conditions	Min	Typ	Max	Unit
<b>Static</b>						
Collector-Emitter Breakdown Voltage	BV <sub>CES</sub>	V <sub>GE</sub> =0V, I <sub>C</sub> =250uA	650		-	V
		V <sub>GE</sub> =0V, I <sub>C</sub> =1mA	650			V
Gate Threshold Voltage	V <sub>GE(th)</sub>	V <sub>GE</sub> =V <sub>CE</sub> , I <sub>C</sub> =250uA	4.0	5.0	6.0	V
Collector-Emitter Saturation Voltage	V <sub>CE(sat)</sub>	V <sub>GE</sub> =15V, I <sub>C</sub> =60A	-	1.85	2.2	V
		T <sub>j</sub> = 25°C T <sub>j</sub> = 150°C	-	2.25		V
Zero gate voltage collector current	I <sub>CES</sub>	V <sub>CE</sub> = 650V, V <sub>GE</sub> = 0V T <sub>j</sub> = 25°C T <sub>j</sub> = 150°C		0.1	40 1000	μA
Gate-emitter leakage current	I <sub>GES</sub>	V <sub>CE</sub> = 0V, V <sub>GE</sub> = ±20V			100	nA
Transconductance	g <sub>fs</sub>	V <sub>CE</sub> = 20V, I <sub>C</sub> = 60A	-	52	-	S

Parameter	Symbol	Conditions	Min	Typ	Max	Unit
<b>Dynamic</b>						
Input capacitance	C <sub>ies</sub>	V <sub>CE</sub> = 30V, V <sub>GE</sub> = 0V, f = 1MHz		3800		pF
Output capacitance	C <sub>oes</sub>			130		
Reverse transfer capacitance	C <sub>res</sub>			70		
Gate charge	Q <sub>G</sub>	V <sub>CC</sub> = 520V, I <sub>C</sub> = 60A, V <sub>GE</sub> = 15V	-	158	-	nC



## Switching Characteristic, Inductive Load

Parameter	Symbol	Conditions	Min	Typ	Max	Unit
<b>Dynamic <math>T_j=25^\circ\text{C}</math></b>						
Turn-on Delay Time	$t_{d(on)}$	$V_{CC} = 400\text{V}, I_C = 60.0\text{A},$ $V_{GE} = 0.0/15.0\text{V},$ $R_g=12\Omega$	-	56	-	ns
Rise Time	$t_r$		-	79	-	ns
Turn-off Delay Time	$t_{d(off)}$		-	165	-	ns
Fall Time	$t_f$		-	81	-	ns
Turn-on Energy	$E_{on}$		-	2.2	-	mJ
Turn-off Energy	$E_{off}$		-	0.89	-	mJ

## Electrical Characteristics of the DIODE ( $T_j=25^\circ\text{C}$ unless otherwise specified)

Parameter	Symbol	Conditions	Min	Typ	Max	Unit
<b>Dynamic</b>						
Diode Forward Voltage	$V_{FM}$	$I_F = 60\text{A}$	-	2.9	-	V
Reverse Recovery Time	$T_{rr}$	$I_F=40\text{A},$ $V_R = 300\text{V},$ $di/dt=600\text{A}/\mu\text{s},$	-	90	-	ns
Reverse Recovery Current	$I_{rr}$		-	17	-	A
Reverse Recovery Charge	$Q_{rr}$		-	900	-	nC



Fig. 1 FBSOA characteristics

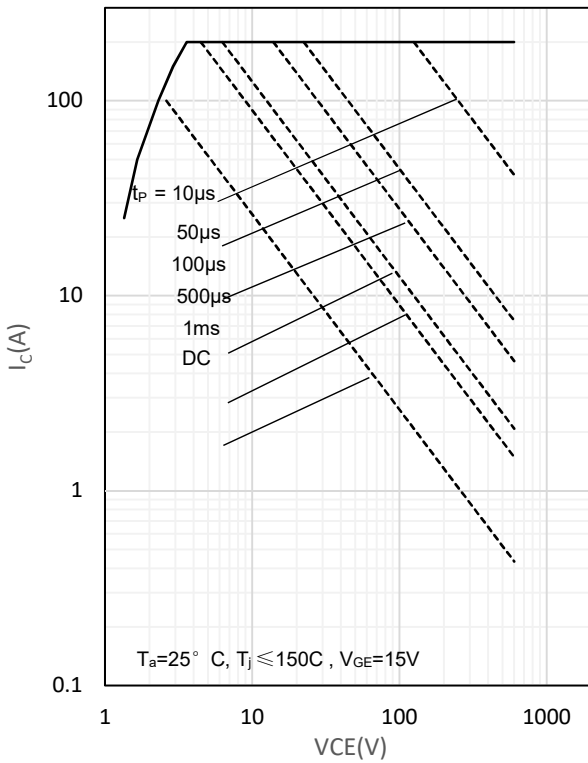

Fig. 2 Power dissipation as a function of  $T_C$

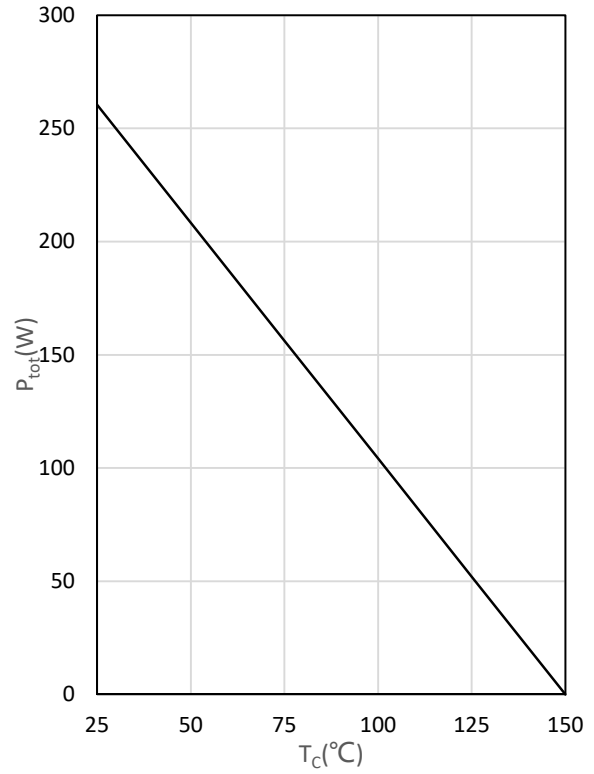

Fig. 3 Output characteristics

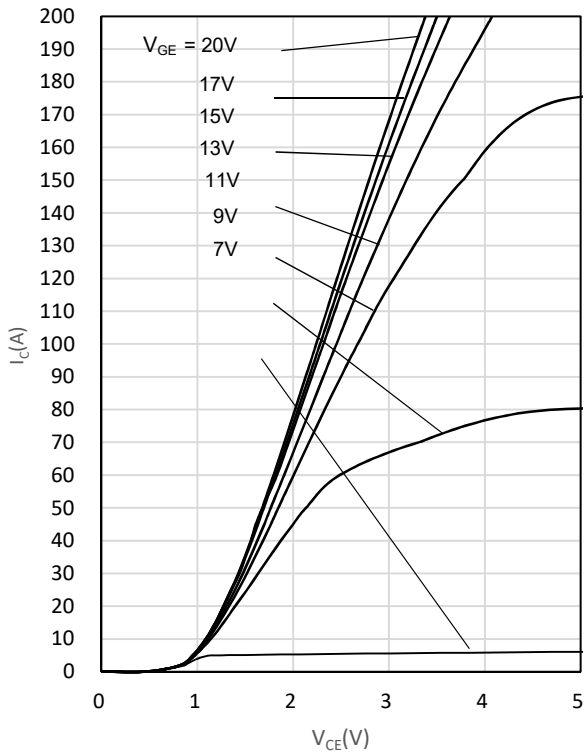

Fig. 4 Saturation voltage characteristics

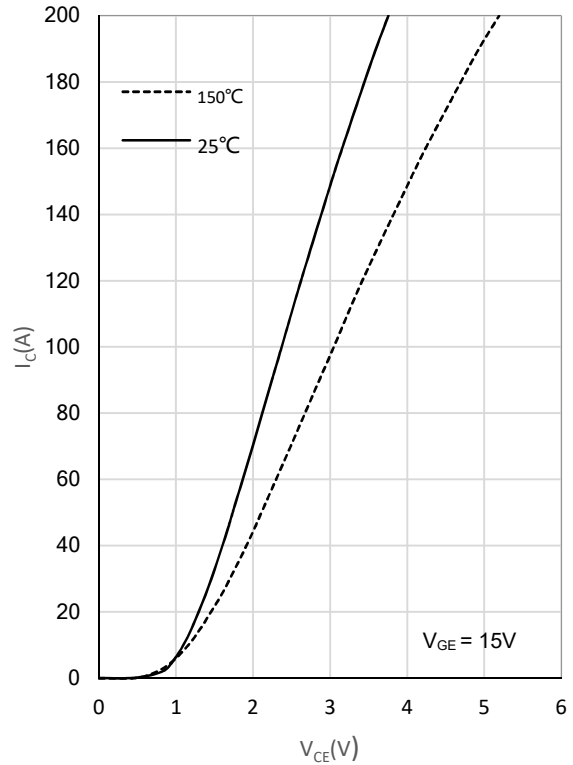



Fig. 5 Switching times vs. gate resistor

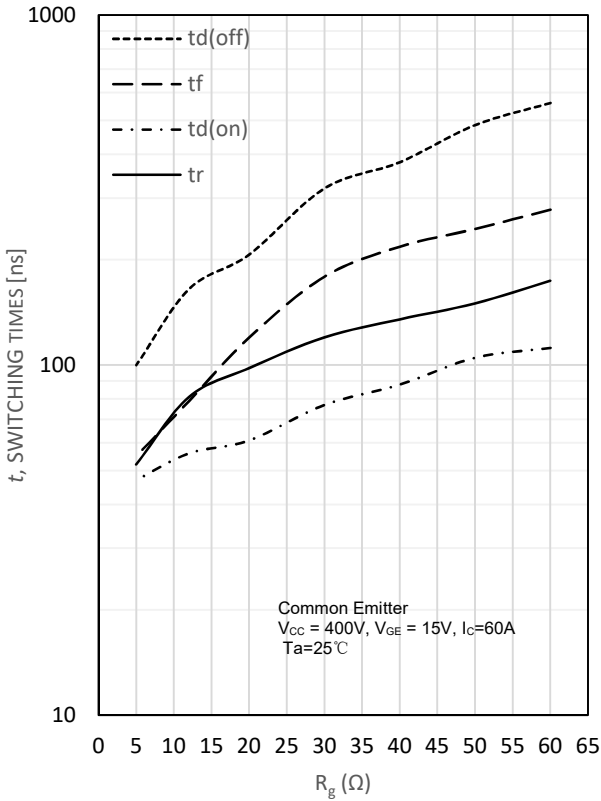

Fig. 6 Switching times vs. collector current

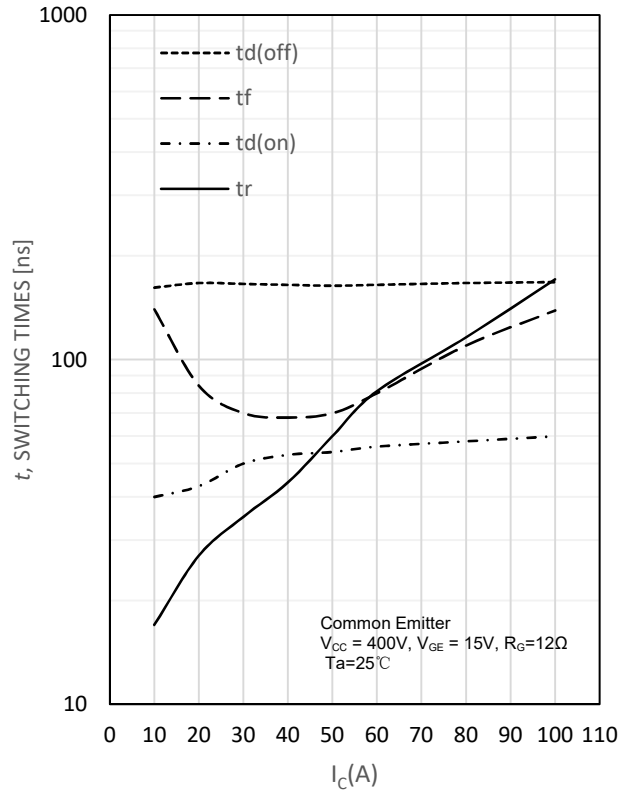

Fig. 7 Switching loss vs. gate resistor

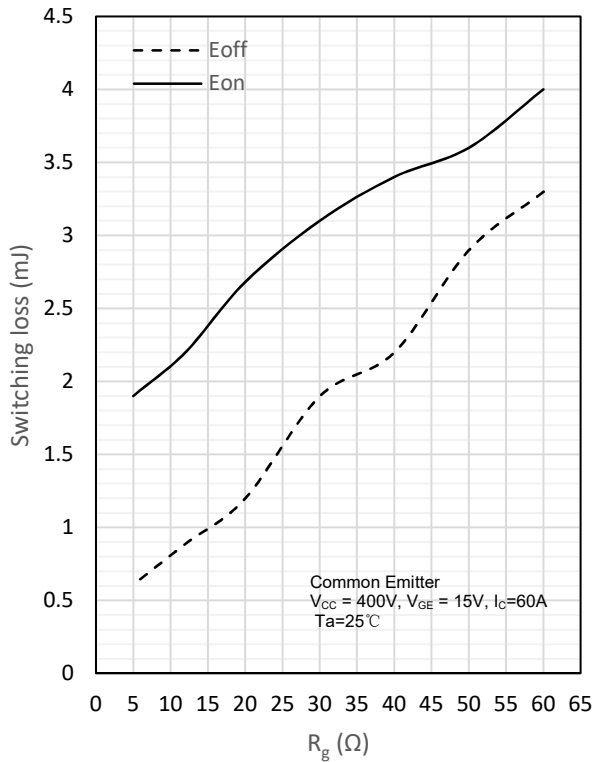

Fig. 8 Switching loss vs. collector current

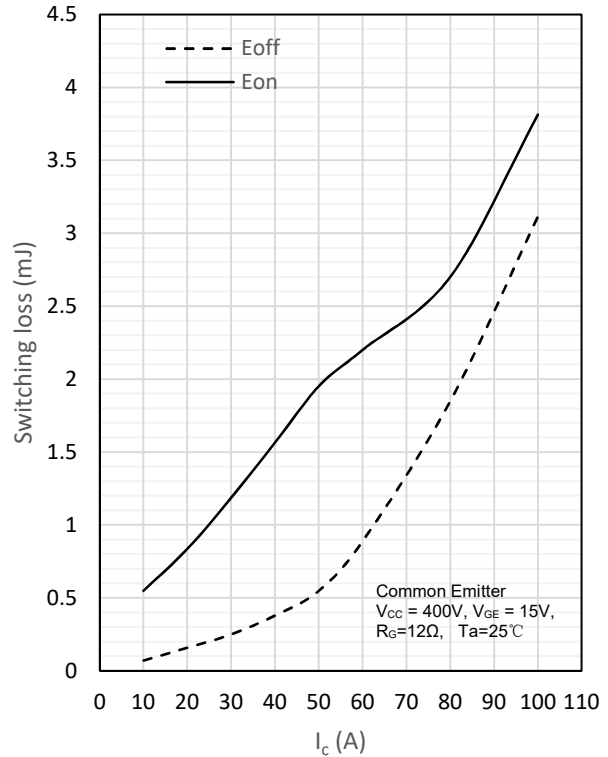



Fig. 9 Gate charge characteristics

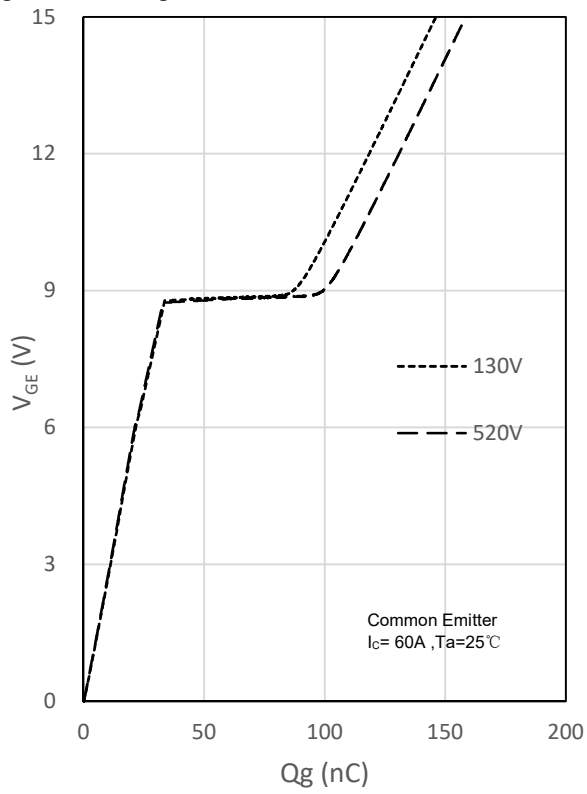
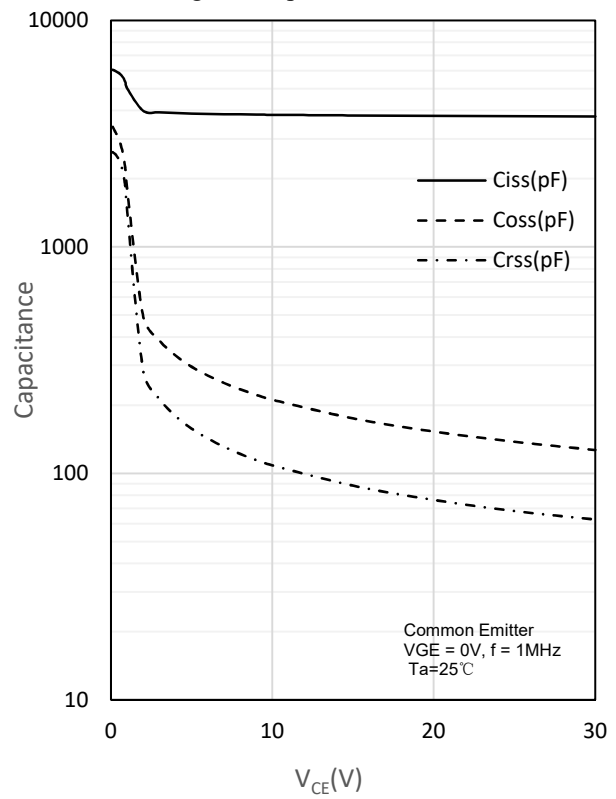
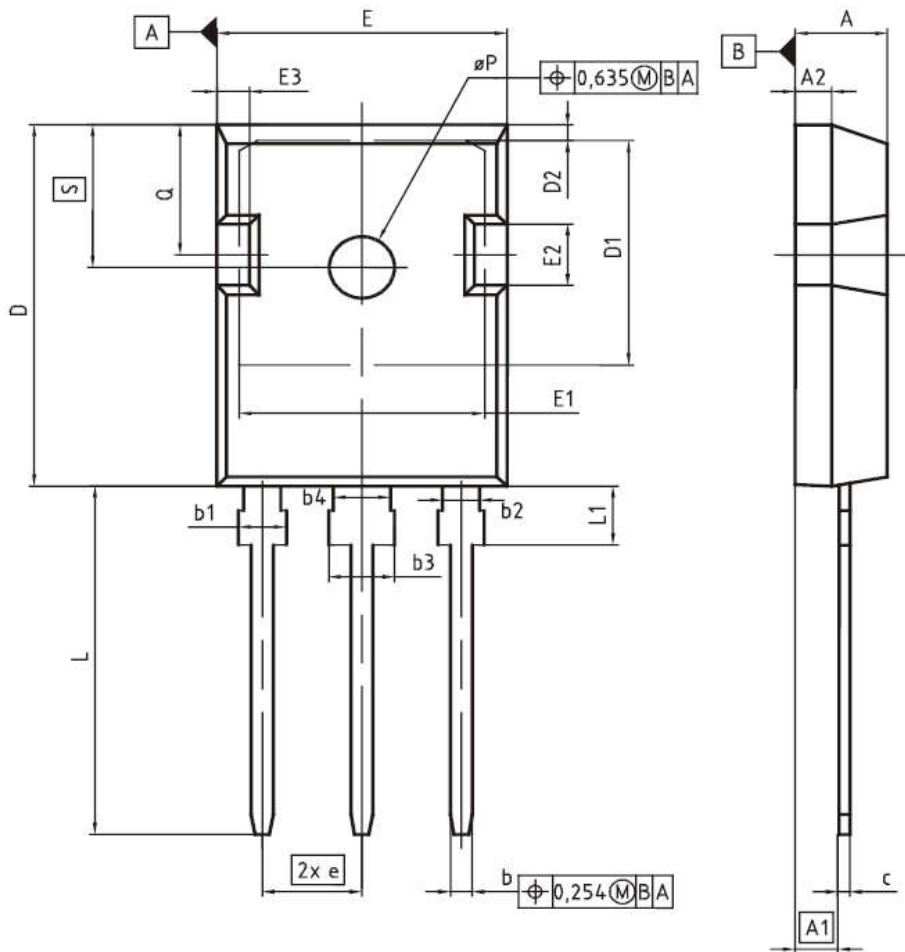

Fig. 10 Capacitance characteristics





PG-TO247-3



DIM	MILLIMETERS		INCHES	
	MIN	MAX	MIN	MAX
A	4.83	5.21	0.190	0.205
A1	2.27	2.54	0.089	0.100
A2	1.85	2.16	0.073	0.085
b	1.07	1.33	0.042	0.052
b1	1.90	2.41	0.075	0.095
b2	1.90	2.16	0.075	0.085
b3	2.87	3.38	0.113	0.133
b4	2.87	3.13	0.113	0.123
c	0.55	0.68	0.022	0.027
D	20.80	21.10	0.819	0.831
D1	16.25	17.65	0.640	0.695
D2	0.95	1.35	0.037	0.053
E	15.70	16.13	0.618	0.635
E1	13.10	14.15	0.516	0.557
E2	3.68	5.10	0.145	0.201
E3	1.00	2.60	0.039	0.102
e	5.44 (BSC)		0.214 (BSC)	
N	3		3	
L	19.80	20.32	0.780	0.800
L1	4.10	4.47	0.161	0.176
øP	3.50	3.70	0.138	0.146
Q	5.49	6.00	0.216	0.236
S	6.04	6.30	0.238	0.248



## X-ON Electronics

Largest Supplier of Electrical and Electronic Components

*Click to view similar products for [IGBT Transistors category](#):*

*Click to view products by [SPTECH manufacturer](#):*

Other Similar products are found below :

[748152A](#) [FGH60T65SHD\\_F155](#) [APT100GT60B2RG](#) [APT13GP120BG](#) [APT20GN60BG](#) [APT20GT60BRDQ1G](#) [APT25GN120B2DQ2G](#)  
[APT35GA90BD15](#) [APT36GA60BD15](#) [APT40GP60B2DQ2G](#) [APT40GP90B2DQ2G](#) [APT50GN120B2G](#) [APT50GT60BRG](#)  
[APT64GA90B2D30](#) [APT70GR120J](#) [NGTB10N60FG](#) [NGTB30N60L2WG](#) [IGP30N60H3XKSA1](#) [STGB15H60DF](#) [STGFW20V60DF](#)  
[STGFW30V60DF](#) [STGFW40V60F](#) [STGWA25H120DF2](#) [FGB3236\\_F085](#) [APT25GN120BG](#) [APT25GR120S](#) [APT30GN60BDQ2G](#)  
[APT30GN60BG](#) [APT30GP60BG](#) [APT30GS60BRDQ2G](#) [APT30N60BC6](#) [APT35GP120JDQ2](#) [APT36GA60B](#) [APT45GR65B2DU30](#)  
[APT50GP60B2DQ2G](#) [APT68GA60B](#) [APT70GR65B](#) [APT70GR65B2SCD30](#) [GT50JR22\(STA1ES\)](#) [TIG058E8-TL-H](#) [IDW40E65D2](#)  
[SGB15N120ATMA1](#) [NGTB50N60L2WG](#) [STGB10H60DF](#) [STGB20V60F](#) [STGB40V60F](#) [STGFW80V60F](#) [IGW40N120H3FKSA1](#)  
[RJH60D7BDPQ-E0#T2](#) [APT40GR120B](#)