

SPECIFICATION FOR APPROVAL

Description NTC THERMISTOR

Type MF72-3-8R2M

Drawn _____

Checked _____

Approve _____

1. Description

The specification is applicable to MF72 NTC thermistors for inrush current depressing.

2. Construct and dimension

2.1 Construct

The coating of MF72 is black insulating resin.

2.2 Outline drawing.

Outline drawing and dimension(Unit:mm).

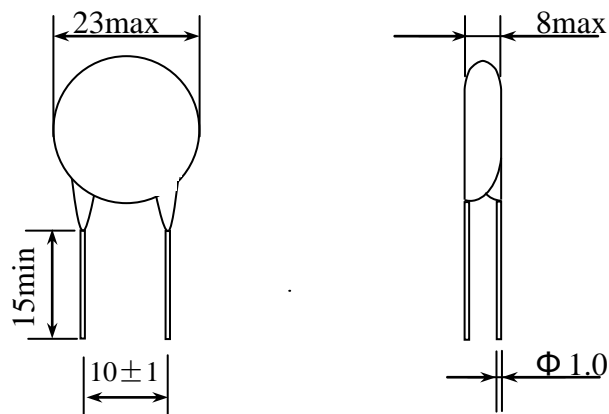

figure 1 Outline drawing and dimension

3. Electrical Parameters

No	Name of parameters	Method of testing	Specification
1	Zero-power resistance R_{25} (Ω)	$25 \pm 0.1^\circ\text{C}$ Temperature: $25^\circ\text{C} \pm 0.1^\circ\text{C}$. Measurements shall be made without self-heating of the devices.	$8.2 \pm 20\%$
2	B-value (K)	$B = (\ln R_1 / R_2) / (1/T_1 - 1/T_2)$ $T_1 = (25 + 273.15) \text{ K}$ $T_2 = (85 + 273.15) \text{ K}$ R_1 — T_1 Resistance at 25°C R_2 — T_2 Resistance at 85°C	≥ 2600
3	Dissipation factor δ ($\text{mW}/^\circ\text{C}$)	In stationary air of $25^\circ\text{C} \pm 2^\circ\text{C}$	≈ 28
4	Thermal time constant τ (s)	In stationary air of $25^\circ\text{C} \pm 2^\circ\text{C}$	≈ 113
5	Maximum current I_{max} (A)	In stationary air of $25^\circ\text{C} \pm 2^\circ\text{C}$ 6A current is continuously applied to the thermistor (see figure 2)	6
6	Residual resistance at I_{max} (Ω)		≤ 0.2
7	Insulation resistance ($\text{M}\Omega$)	In the trough of a 90° metallic V-block measure with a direct voltage of $100 \pm 15\text{V}$	≥ 500

8	Voltage proof (V)	In the trough of a 90° metallic V-block Frequency: 40~60Hz Time: 60s ± 5s	no breakdown or flashover
9	Maximum permissible capacitance C_{\max} (μF)	In stationary air of $25^{\circ}\text{C} \pm 2^{\circ}\text{C}$, AC 220V (see figure 3)	820

4. Environmental Performance

No	Item	Test method and condition	Specification
1	Rapid change of temperature	The thermistor shall be subjected to the procedure of test Na of IEC 60068-2-14 $T_A = -55^{\circ}\text{C}$ $T_B = +155^{\circ}\text{C}$ $t_1 = 30\text{min}$ The number of cycles is 5	No visible damage $ \Delta R/R \leq 15\%$
2	Damp heat (cyclic)	The thermistor shall be subjected to the procedure of test Db of IEC 60068-2-30 The number of cycles is 1	$ \Delta R/R \leq 10\%$ no breakdown or flashover Insulation resistance $\geq 100\text{M}\Omega$
3	Storage in damp heat, steady state	The thermistor shall be subjected to the procedure of test Ca of IEC 60068-2-3 Temperature: $40 \pm 2^{\circ}\text{C}$ Humidity: $(93 \pm 3)\% \text{RH}$ Time: 100h	visible damage $ \Delta R/R \leq 10\%$ no breakdown or flashover Insulation resistance $\geq 100\text{M}\Omega$

5. Mechanical Performance

No	Item	Test method and condition	Specification
1	Resistance to soldering heat	The thermistor shall be subjected to the procedure of method 1A of test Tb of IEC 60068-2-20 Temperature of the solder bath: $260 \pm 5^{\circ}\text{C}$ Immersion time: $5 \pm 1\text{s}$	No visible damage $ \Delta R/R \leq 5\%$
2	Robustness of terminations	The thermistor shall be subjected to the procedure of test U of IEC 60068-2-21 Test U_{a1} : tensile force—10N Test U_b : bending force—5N	No visible damage $ \Delta R/R \leq 5\%$
3	Vibration	The thermistor shall be subjected to the procedure of test Fc of IEC 60068-2-6 Mounting mean: by body of resistance Frequency: 10~500Hz Swing: 0.75mm or 100m/s^2 Time: 6h	No visible damage $ \Delta R/R \leq 5\%$

4	Bump	The thermistor shall be subjected to the procedure of test Eb of IEC 60068-2-29 Mounting mean: by body of resistance acceleration: 250m/s^2 time of pulse: 6ms time of bump: 4000	No visible damage $ \Delta R/R \leq 5\%$
---	------	--	--

6. Endurance test

No	Item	Test method and condition	Specification
1	Endurance at room temperature with applied continuous maximum current	Current: 6A Time: 1000h	No visible damage $ \Delta R/R \leq 20\%$
2	Storage in dry heat	Temperature: $+155^\circ\text{C}$ Time: 1000h Storage at upper category temperature	No visible damage $ \Delta R/R \leq 20\%$

7. Maximum current I_{max} test circuit

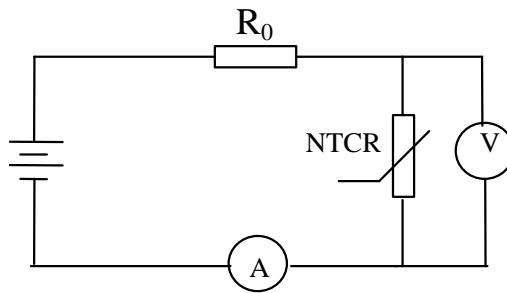

figure2 Maximum current I_{max} test circuit

8. Maximum capacitance C_{max} test circuit

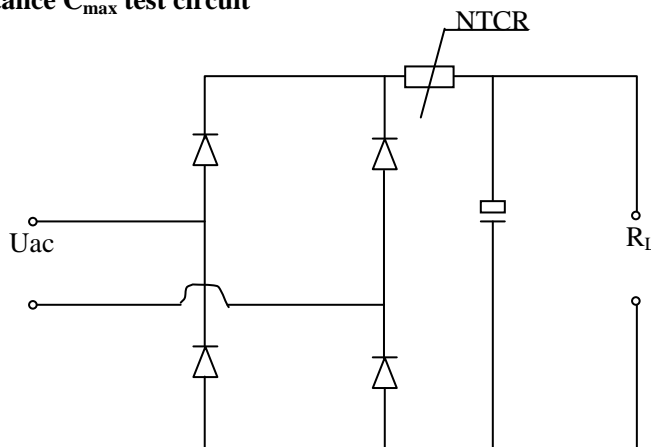

figure 3 Maximum capacitance C_{max} test circuit

9. Character curve

9.1 R—T curve

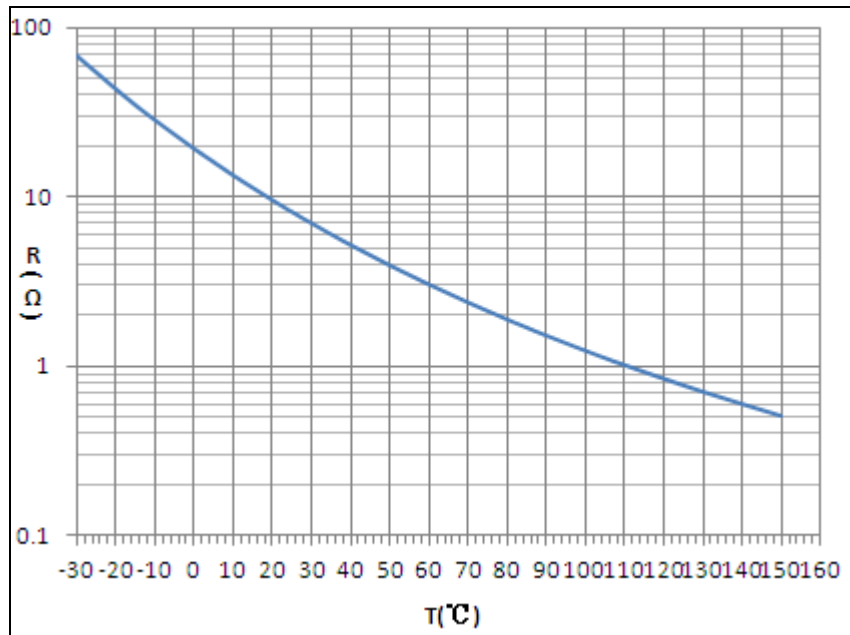

figure 4 R—T curve

9.2 V—I curve

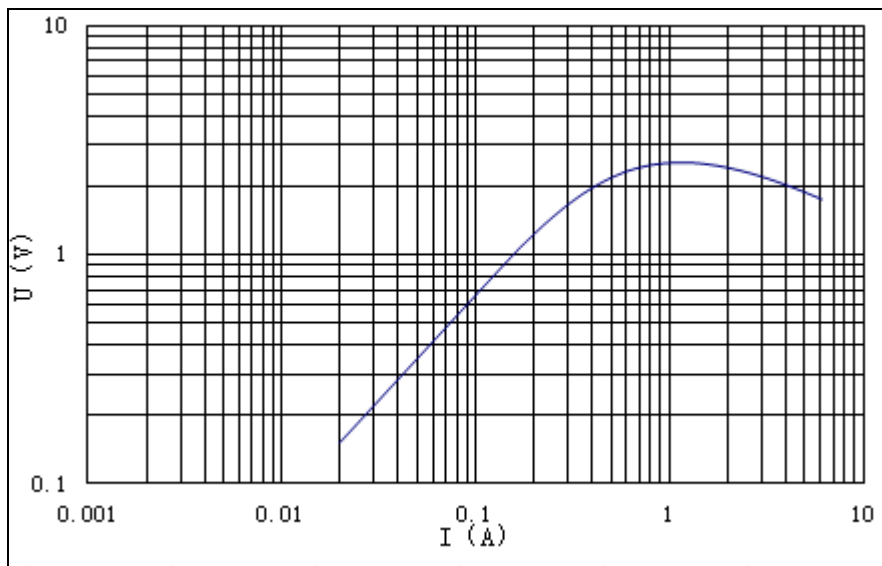

figure 5: V—I curve

9.3 Decreased maximum current I_{\max} curve

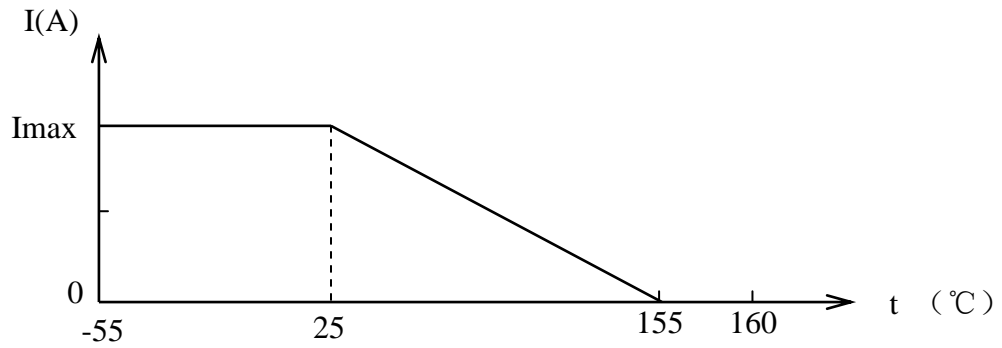

figure 6 Decreased maximum current I_{\max} curve

10. Marking example

10.1 Marking example



MF72-3
8R2M

figure 7 Marking example

10.2 Marking note:



_____	Trade mark
MF72 _____	Type
-3 _____	Body size: 20mm
8R2 _____	R_{25} Nominal resistance: 8.2Ω
M _____	Tolerance: $\pm 20\%$

11. Approvals

11.1 UL recognized



file #: E184918

11.2 VDE authentication



file #: 40020558

11.3 CQC recognized



file #: CQC09001034906

12. Note

12.1 MF7 series NTCR is designed for special usage. So it should only be used in specified status.

12.2 MF7 series NTCR should be used in specified environment. Otherwise it may cause the performance drop, even breakdown the product.

(1) Working current should not be over the specified parameter.

(2) Please avoid to use the product in caustic、volatile、flammable ambient and places near water、salt、oil. It is also prohibited to use the product under vacuum, low air pressure, high air pressure condition.

12.3 MF72 Series NTCR should be stored in the following condition:

Temp. $-10^{\circ}\text{C} \sim +40^{\circ}\text{C}$, Relative humidity $<80\%$

And it should avoid sudden change of humidity, direct sunshine, caustic atmosphere, dust environment and mechanical destroy.

X-ON Electronics

Largest Supplier of Electrical and Electronic Components

Click to view similar products for [Thermistors - NTC category](#):

Click to view products by [SR Passives manufacturer](#):

Other Similar products are found below :

[B57620C5103J062](#) [238164043103](#) [238164063109](#) [238164063222](#) [30054-4](#) [B57621C0224J062](#) [B57621C333J62](#) [103AT-5-1P-FT](#)
[B57364S121M](#) [NTCS-10-3R-4](#) [MF11-473J-B4250](#) [B57164K0102K000](#) [B57164K0153K000](#) [B57164K0223K000](#) [B57164K0472K000](#)
[B57236S0509M](#) [B57237S0150M](#) [B57237S0479M](#) [B57237S0509M](#) [MF11-332J-B4050](#) [MF11-333J-B4050](#) [MF11-682J-B4250](#) [MF11-683J-](#)
[B4250](#) [MF72-1D20M](#) [01C1002JP](#) [01C1501JP](#) [01M1002FF](#) [01M2251SFC3](#) [01M3002FP](#) [01M6001FP](#) [02C1001JF](#) [02C5000JF](#) [04T1003FF](#)
[04T5002FF](#) [04T1003FP](#) [08M3002FP](#) [09M1002FP](#) [NXRT15WF104FA1B030](#) [01T1002FF](#) [01T1002JF](#) [02C0500JF](#) [GC1074U-3-0](#) [GC1396V-](#)
[3-200](#) [09M1002FF](#) [EC95H303W](#) [EC95G503W](#) [NCP15WM224E03RC](#) [NCP15WM474J03RC](#) [NCP15XH103E03RC](#) [NCP15XQ102J03RC](#)