

SRPASSIVES

SMD Ceramic Trimmer





- ◆ Low capacitance drift.
- ◆ High durability from vibration, dust, moisture and flux.
- ◆ Colour coded case permits easy identification
- ◆ Very good Q and high resonant frequency
- ◆ Designed for reflow soldering.
- ◆ Small size with external dimension of 3.2(W) x 4.5(L) x 1.5(T) mm

Ultra-thin miniature SMD type Chip Trimmer Capacitors for miniaturization of electronic equipment.

Very thin dustproof structure and very low capacity drift after adjustment,

Are most suited to the fine adjustment of items. The plastic is good mechanical strength and is a high temperature liquid-crystal polymer with dielectric loss.

RATINGS AND CHARACTERISTICS

Item	Part No	SR300TR	SR600TR	SR101TR	SR201TR	SR301TR
		3pF	6pF	10pF	20pF	30pF
		Black	Blue	Ivory	Pink	Green
Model						
Capacitance(pF Min)		1.5 MAX	2.0 MAX	3.0 MAX	5.5 MAX	8.0MAX
Capacitance(pF Max)		3.0 ⁺⁵⁰ -0%	6.0 ⁺⁵⁰ -0%	10.0 ⁺⁵⁰ -0%	20.0 ⁺⁵⁰ -0%	29.0 ⁺⁵⁰ -0%
Capacitance Drift (Max)		±2%	±2%	±2%	±3%	±3%
Temperature Coefficient (ppm/°C)		NPO±300	NPO±200	N600±400	N900±400	N1200±400
Q Value (at 1 Mhz, C max)		300min	500 min	700 min	500 min	250 min
DC Working Voltage		100 VDC	100 VDC	100 VDC	100 VDC	100 VDC
DC Withstanding Voltage		220 VDC	220 VDC	220 VDC	220 VDC	220 VDC
Insulation Resistance		10 ⁴ MΩMin				
Operating Temperature		-25°C to 85°C				
Rotation Torque		15 ~ 72 gf.cm				

SRPASSIVES

SMD Ceramic Trimmer

DIMENSIONS (mm)

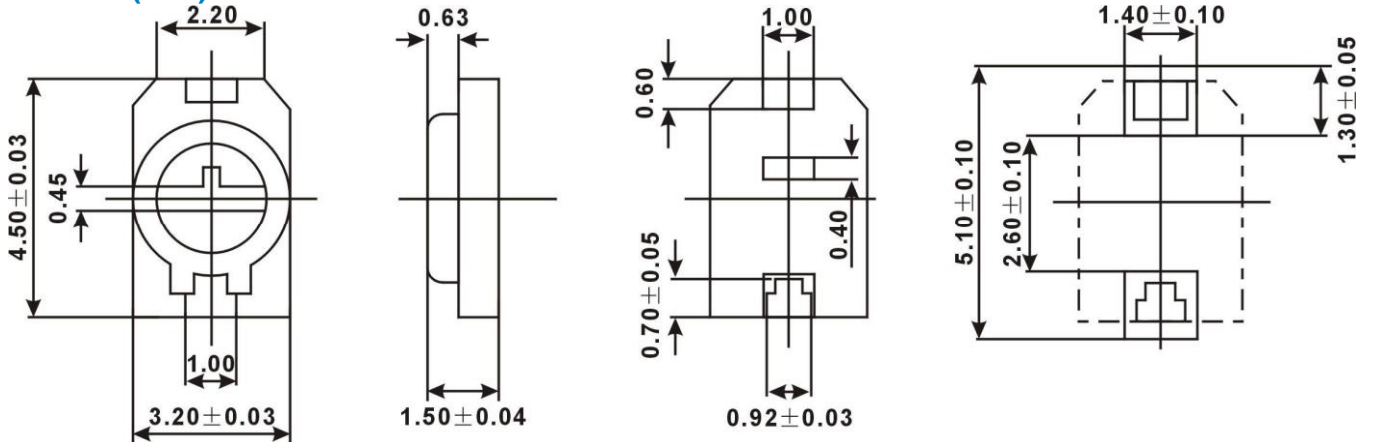

TAPE & REEL SPECIFICATIONS (mm)

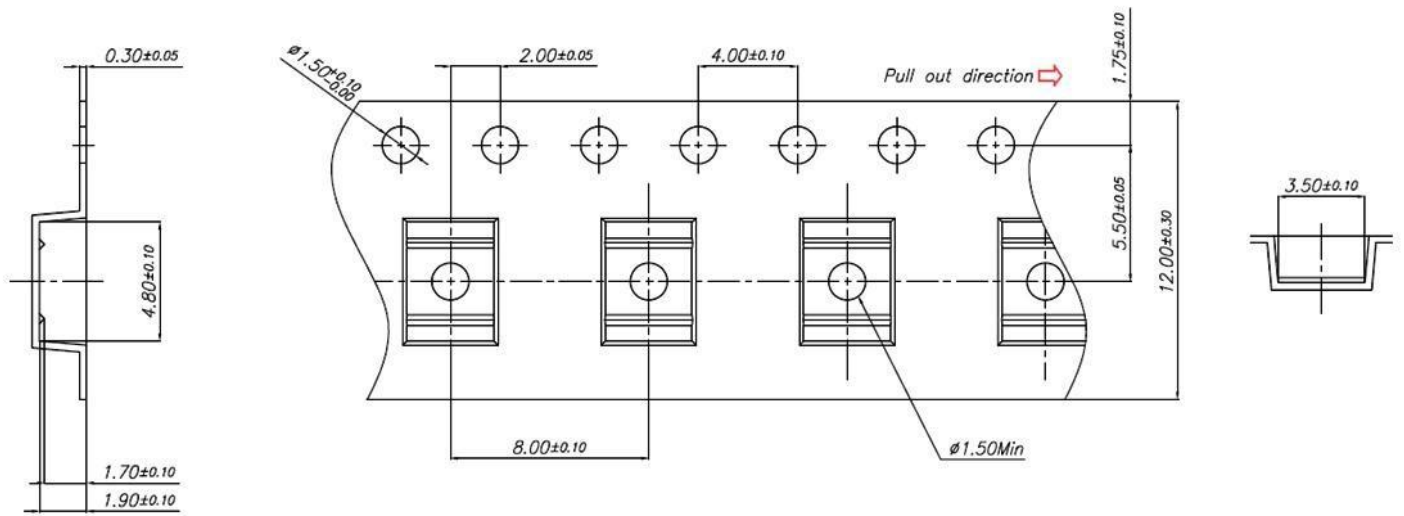

Note: Specifications are subject to change without notice.

X-ON Electronics

Largest Supplier of Electrical and Electronic Components

Click to view similar products for [Trimmer/Variable Capacitors](#) category:

Click to view products by [SR Passives](#) manufacturer:

Other Similar products are found below :

[GKY20086](#) [GNC8R050](#) [GXC90000](#) [PC51H230](#) [STPTIC-56G2C5](#) [27271LSL](#) [27281SL](#) [27283-3R10](#) [GYB5R000](#) [GHC5R500](#) [GZD80000](#)
[NMAM25HV](#) [NMA1J12HVS](#) [SR600TR](#) [SR101TR](#) [SR201TR](#) [SR301TR](#) [GYC15000](#) [CV31A180](#) [TZB4Z030AA10R00](#) [BFC280800006](#)
[STPTIC-47F1M6](#) [STPTIC-27F1M6](#) [GYA5R000](#) [JZ030HV](#) [JZ300HV](#) [JZ060HV](#) [CTZ3E-10A-W5-PF](#) [189-0504-005](#) [538-011 D 9-35LF](#)
[KG10](#) [KM8](#) [KT10](#) [TP6](#) [LXRW0YV330-056](#) [LXRW0YV600-054](#) [LXRW0YV900-053](#) [LXRW19V201-058](#) [LXRW19V330-050](#)
[TZ03Z500E169B00](#) [TZ03Z100N169B00](#) [TZB4Z030AA10B00](#) [NMTM120CEK](#) [PE64102B-Z](#) [PE64906B-Z](#) [PE64907B-Z](#) [PE64904C-Z](#)
[PE64909B-Z](#) [GAA14001](#) [GAA16006](#)