



Product Description

The MediaSensor™ (P51) family of bulk micro-machined, absolute, sealed and gauge pressure sensors are for both harsh and benign media with superior accuracy over an operating temperature. These compact, robust sensors are well suited for a variety of automotive, industrial and commercial applications.

Typical Applications

- Refrigeration
- Hydraulics
- Pneumatics
- HVAC
- Fuel Cells
- Compressors
- Agriculture
- Spraying Systems
- Pumps
- Flow
- Process Control
- Robotics

Standard Pressure Ranges

- **Sealed Gauge:** 15 - 7,500 PSIS
- **Gauge:** 20 - 300 PSIG
- **Absolute:** 15 - 7,500 PSIA

Product Features

- **Superb Accuracy**
 - +/- 1% full scale for 15 PSI to 60 PSI
- **Pressure Ranges:** 15 PSI up to 7,500 PSI
- **Output Options**
 - Four options available. (See page 2)
- **Temperature Ranges:** -40 °C to 125 °C
- **Standard and custom options available for OEM quantities**
- **Maximum Flexibility:** Custom ASIC provides temperature compensation across a large pressure range.
- **Excellent price/performance ratio:** Performance is always accurate, repeatable, and reliable. The premium quality and performance of these sensors come at a friendly price.
- **Compact, Robust Packaging:** All laser-welded stainless steel design for optimal media isolation in compact size.
- **Chemical Compatibilities:** Any gas or liquid compatible with 304L and 316L stainless steel; for example, motor oil, diesel, hydraulic fluid, brake fluid, water, waste water, hydrogen, nitrogen, and air. Designed to be used in media isolated mediums.
- **Snubber Port Option:** The SSI snubber is intended to protect the sensing element from physical damage due to a pressure differential spike in the measured fluid. Physically, the snubber is a small orifice (.016" diameter) at the port opening.



Typical Connections

The following torque limits should be used when mounting the MediaSensor™ pressure port.

Straight Thread w/ O-Ring	Recommended Torque
High Pressure (>750 PSI)	300 in lbs
All others with port types: I	150 in lbs
Parts with ports: U	120 in lbs
NPTF Thread:	2 "Turns From Finger Tight"

MediaSensor™ 4 - 20 mA Output Connections:

- 1) Connect the Power Lead (Red) to the positive terminal of the supply voltage.
- 2) Connect the Return Lead (White) to the positive terminal of the current measuring device.
- 3) Connect the negative terminal of the current measuring device to the negative terminal of the supply voltage.

MediaSensor™ Voltage Output Connections:

- 1) Connect the Power Lead (Red) to the positive terminal of the supply voltage.
- 2) Connect the Ground Lead (Black) and the negative terminal of the supply voltage to the negative input of your voltage measurement equipment.
- 3) Connect the V_{out} Lead (White) to the positive input of your voltage measurement equipment.

Typical Connector Options

Packard Connector Transmitter (4 to 20 mA)

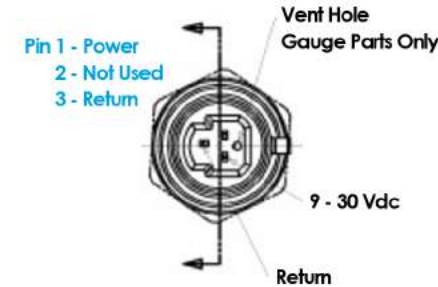

Packard Connector Transducer (1 to 5 Vdc or 0.5 to 4.5 Vdc)

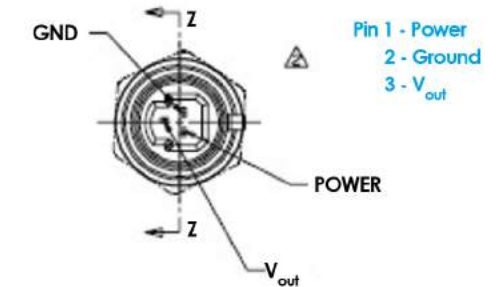

Deutsch Connector Transmitter (4 to 20 mA)

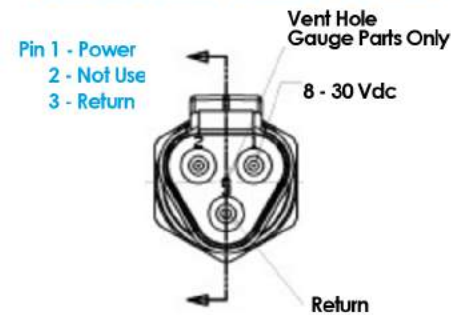

Deutsch Connector Transducer (1 to 5 Vdc or 0.5 to 4.5 Vdc)

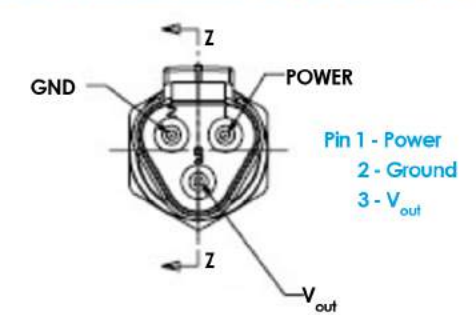

M12 Connector Transmitter (4 to 20 mA)

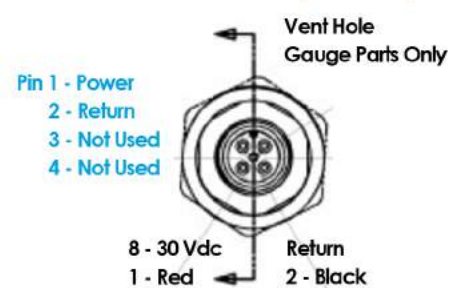

M12 Connector Transducer (1 to 5 Vdc or 0.5 to 4.5 Vdc)

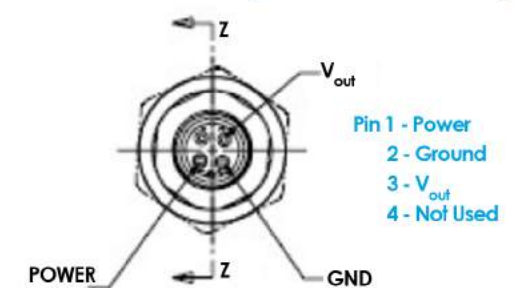

DIN 43650 Transmitter Connector

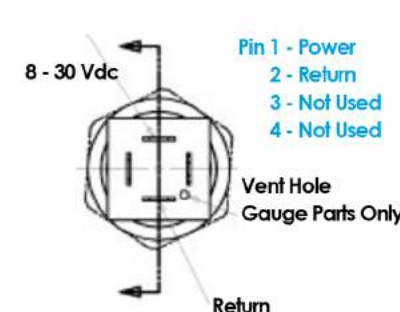

DIN 43650 Transducer Connector

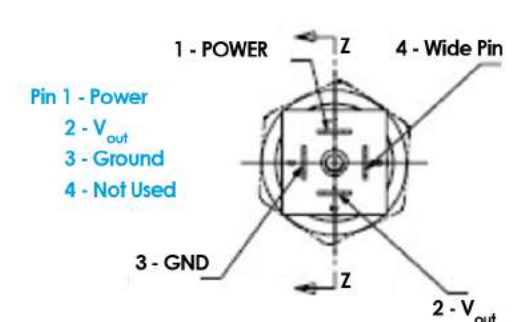



Connector and Port Options

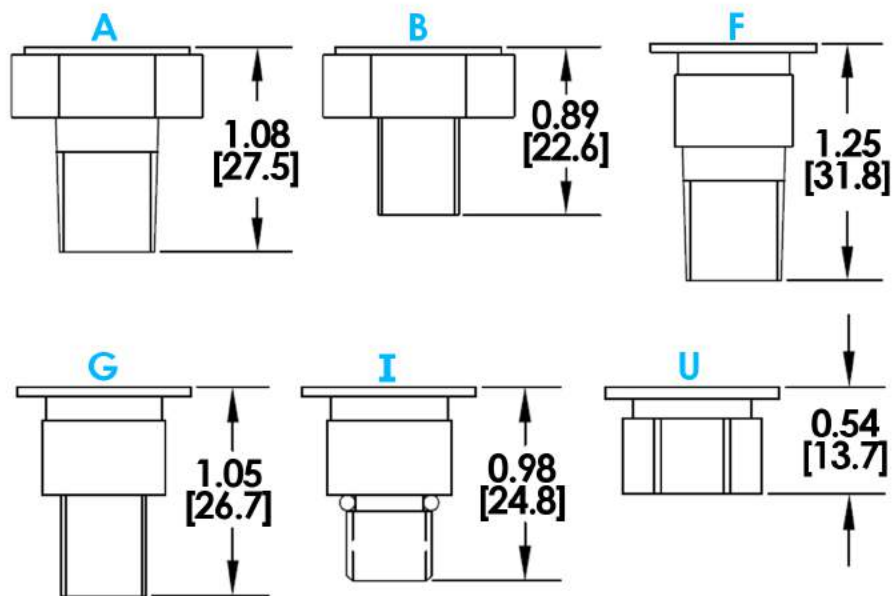
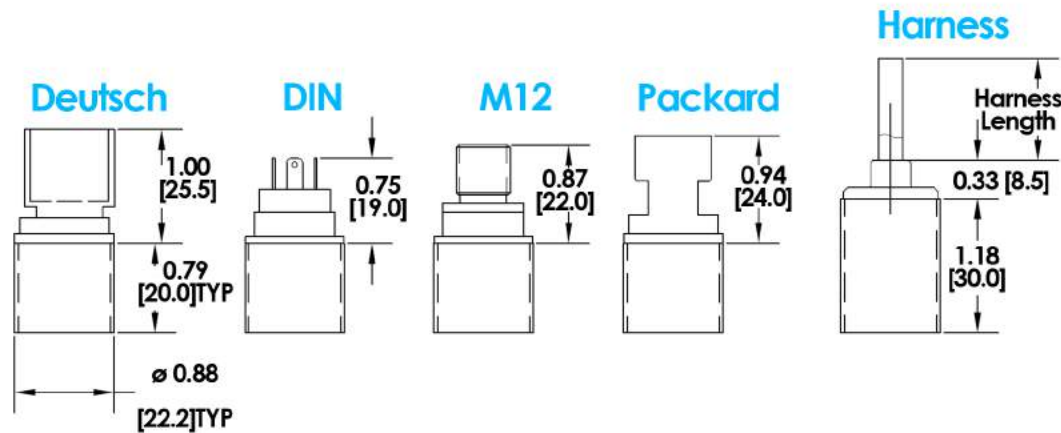

Harness Options

MediaSensor™ is readily available in a large selection of standard packaging options. MediaSensor™ offers an integral harness with six standard lengths and four standard readily available connectors (Packard, Deutsch, M12, and Mini DIN). In addition, SSI will work with the customer to meet their needs with custom options for large volume orders; i.e. special fittings and connectors, special pressure ranges, operating temperature, and increased accuracy.

Integral Harness: Standard lengths of 6", 12", 18", 24", 36", and 72". The harness can be constructed to either PVC Jacketed 18 or 24 AWG Wire.

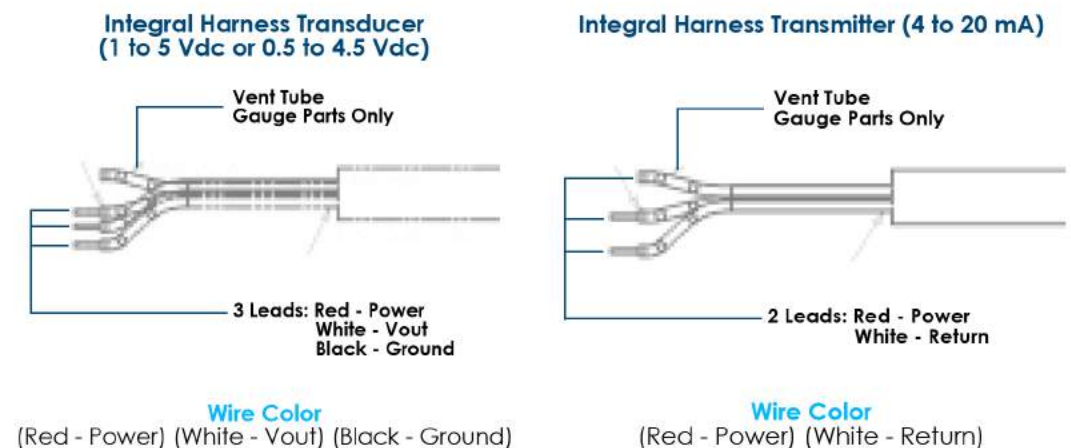



MediaSensor™ (P51) Ordering System

The following explains SSI's MediaSensor™ pressure sensor order number sequence.

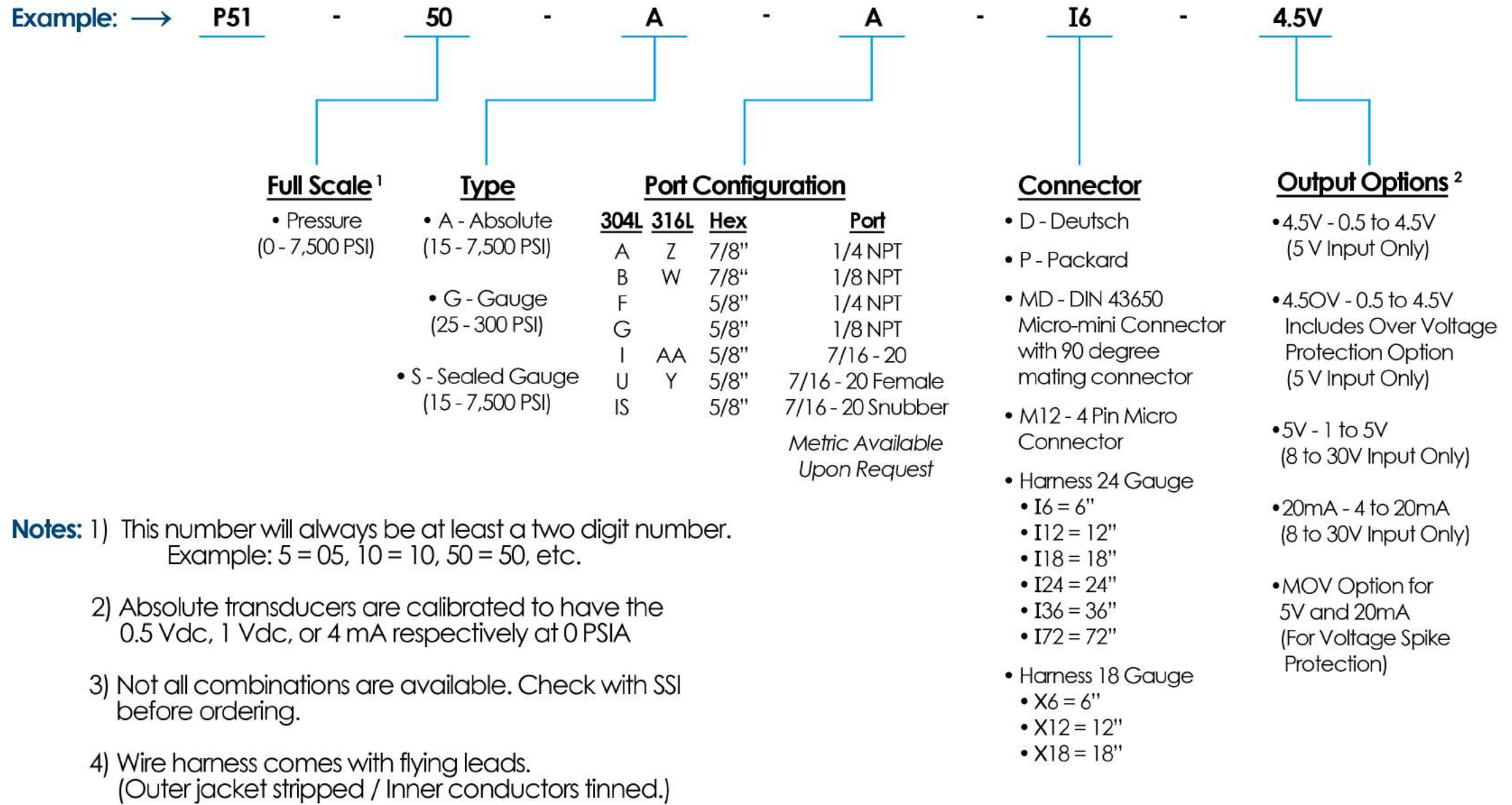

Notes: 1) This number will always be at least a two digit number.
Example: 5 = 05, 10 = 10, 50 = 50, etc.

- 2) Absolute transducers are calibrated to have the 0.5 Vdc, 1 Vdc, or 4 mA respectively at 0 PSIA
- 3) Not all combinations are available. Check with SSI before ordering.
- 4) Wire harness comes with flying leads.
(Outer jacket stripped / Inner conductors tinned.)



Performance Specifications (all values at 22 °C unless noted otherwise)

Output Type	0.5 to 4.5 Volts	1 - 5 Volts	4 - 20 mA
Accuracy	< ± 1.00% FS	< ± 1.00% FS	< ± 1.00% FS
Temperature Error (-40°C to 105°C)	< ± 1.00% FS	< ± 1.00% FS	< ± 1.00% FS
Zero Pressure Offset	0.50 V	1.0 V	4.0 mA
Full Scale Output (Output at Pressure FS)	4.50 V	5.0 V	20.0 mA
Operating Temperature	-40 °C to 125 °C	-40 °C to 125 °C	-40 °C to 125 °C
Storage Temperature	-40 °C to 125 °C	-40 °C to 125 °C	-40 °C to 125 °C
Proof Pressure	3 X FS	3 X FS	3 X FS
Burst Pressure	10X FS or 15,000 psi	10X FS or 15,000 psi	10X FS or 15,000 psi
Reverse Voltage (+/- 16V over 5 min.)	Available	Available	Available
Over Voltage (+/- 16 V over 5 min.)	Available	Not Available	Not Available

Electrical Specifications

Output Type	0.5 to 4.5 Volts	1 - 5 Volts	4 - 20 mA
Supply Voltage	5 +/- 0.5 Volts	8 to 30 Volts	8 to 30 Volts
Current Draw	< 6 mA	< 3 mA	Not Applicable
Output Current	0.45 mA Max (Sink or Source)	0.45 mA Max (Sink or Source)	4 - 20 mA
Response Time (Pressure/Output)	< 1 ms	< 1 ms	< 1 ms

Reliability and Environmental Performance

Parameter	Value	Units
Pressure/Temperature Cycles	> 1.8 x 10	Cycles
Thermal Shock	250	Cycles
Vibration	144	Hours
EMC Compatibility	150	v/m
Humidity	250	Hours
Weight	≤ 85	Grams



More Information

More data sheets available online at ssi-sensors.com/library.php , or click on the data sheets icon found on our website.

Other data sheets provided for:

Pressure

- P51 MediaSensor™ Ultra Low Pressure
- P31 MediaSensor™
- P61 MediaSensor™
- Media Gauge Family Overview (Digital Pressure Gauges)

Other Products

- Ultrasonic Level Sensors
- Point Level Switch
- TULC
- Speed and Position Sensors
- *And More*



Data Sheets

Contact

SSI Technologies, Inc.

Corporate Office

3200 Palmer Drive
Janesville, WI, 53546
1 (608) 757-2000

SSI Technologies, Inc.

Controls Division

1309 Plainfield Avenue
Janesville, WI, 53545
1 (608) 758-1500

SSI Technologies GmbH

Technical Center

Chiemgaustrasse 148
81549 Muenchen, Germany
+49 89 716 7779 - 10

SSI Technologies s.r.o.

Manufacturing & Operations

VGP Park Ústí nad Labem; Přestanov č.p. 113; 403 17 Přestanov, Česká republika (Czech Republic)



X-ON Electronics

Largest Supplier of Electrical and Electronic Components

Click to view similar products for [ssi technologies](#) manufacturer:

Other Similar products are found below :

[P51-5-G-UC-I36-4.5V-000-000](#) [P51-200-G-B-M12-20MA-000-000](#) [P51-50-A-A-MD-20MA-000-000](#) [P51-75-G-A-I36-20MA-000-000](#) [P51-3-G-UB-I36-4.5V-000-000](#) [P51-3-G-UC-I36-4.5V-000-000](#) [P51-15-G-UC-I36-4.5V-000-000](#) [P51-500-A-A-I36-20MA-000-000](#) [P51-100-S-A-I36-4.5V-000-000](#) [P51-100-G-M-P-4.5V-000-000](#) [P51-500-S-A-I36-20MA-000-000](#) [P51-300-S-A-I12-4.5V-000-000](#) [P51-200-G-B-I36-20MA-000-000](#) [P51-50-G-A-I36-4.5V-000-000](#) [P51-3000-A-A-I12-20MA-000-000](#) [P51-10-G-UC-I36-5V-000-000](#) [P51-50-A-B-M12-4.5V-000-000](#) [P51-50-G-B-M12-20MA-000-000](#) [P51-50-A-A-I36-5V-000-000](#) [MG-5000-A-MD-R](#) [P51-50-A-A-P-20MA-000-000](#) [P51-50-G-B-I36-20MA-000-000](#) [P51-100-G-G-P-4.5V-000-000](#) [P51-3-G-UC-I36-5V-000-000](#) [P51-50-A-A-I36-4.5OVP-000-000](#) [P51-1000-A-A-I36-20MA-000-000](#) [P51-1000-S-B-I36-20MA-000-000](#) [P51-5-G-UB-I36-4.5V-000-000](#) [P51-500-A-A-I36-5V-000-000](#) [P51-50-A-B-I36-4.5V-000-000](#) [P51-50-G-A-I36-20MA-000-000](#) [P51-50-G-B-I36-5V-000-000](#) [P51-50-A-B-I36-4.5OVP-000-000](#) [P51-1000-S-B-I36-5V-000-000](#) [P51-15-G-UB-I36-5V-000-000](#) [P51-15-G-UB-I36-20MA-000-000](#) [P51-50-A-B-I36-5V-000-000](#) [P51-300-G-B-I36-4.5V-000-000](#) [P51-3-G-UB-I36-20MA-000-000](#) [P51-5-G-UC-I36-20MA-000-000](#) [DFT-110](#) [P51-100-A-B-I36-4.5V-000-000](#) [P51-500-A-B-I36-4.5OVP-000-000](#) [MG1-5-A-9V-R](#) [MG-50-A-9V-R](#) [MG1-100-A-9V-R](#) [P51-100-A-B-I36-5V-000-000](#) [P51-300-G-A-I36-20MA-000-000](#) [P51-100-G-B-M12-20MA-000-000](#) [P51-50-A-B-I36-20MA-000-000](#)