



四川索斯特电子有限公司
Sichuan Source-Set Electronics Co., Ltd

承 认 书

SPECIFICATIONS FOR APPROVAL

客户名称:
Customer: _____

产品名称: 石英晶体谐振器
Description: CRYSTAL RESONATOR

产品型号: HC-49S/DIP
SPECIES _____

标称频率: 8.000MHz 20PF
FREQUENCY _____

料 号:
MATERIAL CODE SCBYS08X00000ELRK

供应商确认				客户确认			
品管部 QC Dept	工程部 Engineer Dept	业务部 Trade Dept	<input checked="" type="checkbox"/> 合格 PASS	品管部 QC Dept	工程部 Engineer Dept	采购部 Purchase Dept	<input type="checkbox"/> 合格 PASS
郭 淘	梁 雄	陈 晓 群	<input type="checkbox"/> 不合格 NG				<input type="checkbox"/> 不合格 NG

公司地址: 四川省泸县工业园 B 区明星路 204 号 (坤羽) 5、6 栋

电话: 0830-8172777、8106299 传真: 0830-8106266



四川索斯特电子有限公司
Sichuan Source-Set Electronics Co., Ltd

GENERAL SPECIFICATIONS (电气特性) :

1. Holder type: (型号)	HC-49S	
2. Normal Frequency: (标称频率)	8.000MHz	
3. Oscillation Mode: (振动模式)	AT	
4. Load Capacitance(CL): (负载电容)	20 PF	
5. Frequency Tolerance 25±3℃: (频率偏差 25±3℃)	± 20 PPM	
6. Effective Series Resistance: (等效电阻)	≤60 Ω	
7. DLD2 (不同功率下之最大与最小阻抗差值)	≤ 20 Ω	0.01 uW~100 uW 10 steps
8. RLD2 (不同功率下之最大阻抗值)	≤60 Ω	0.01 uW~100 uW 10 steps
9. FDLD (不同功率下之最大与最小 FR 差值)	≤ 6PPM	0.01 uW~100 uW 10 steps
10. Shunt Capacitance(C0): (静态电容)	≤ 7 PF	
11. Typical drive level: (激励功率)	100 uW TYP.	
12. Operation Temperature Range: (工作温度范围)	-40℃ to +85℃	
13. Stability Over Temperature Range: (工作温度频率偏差)	±30 PPM at -40℃ to+85℃	
14. Insulation Resistance: (绝缘阻抗)	≥500 MΩ at DC 100V	
15. Aging: (老化率)	±3 PPM/Year	
16. Storage Temperature: (存储温度)	-40℃ to +85℃	
17. Test circuit (测试仪器)	S&A 250B Pi-Network Crystal Measurement System	

Remark (备注) :

DIMENSIONS SPECIFICATIONS (外形尺寸)

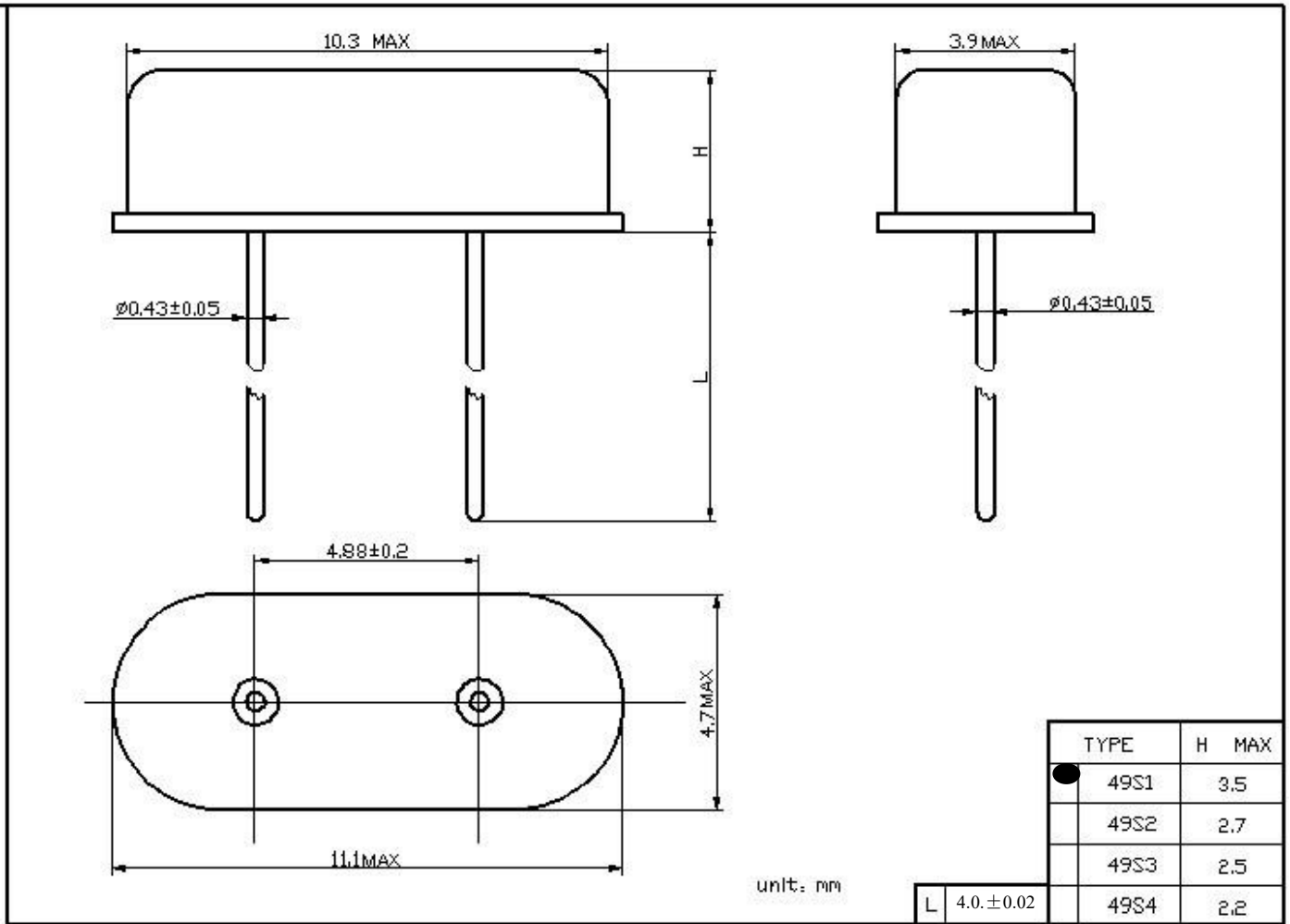

MASK (印字)



Report of bills of materials and suppliers (物料清单)

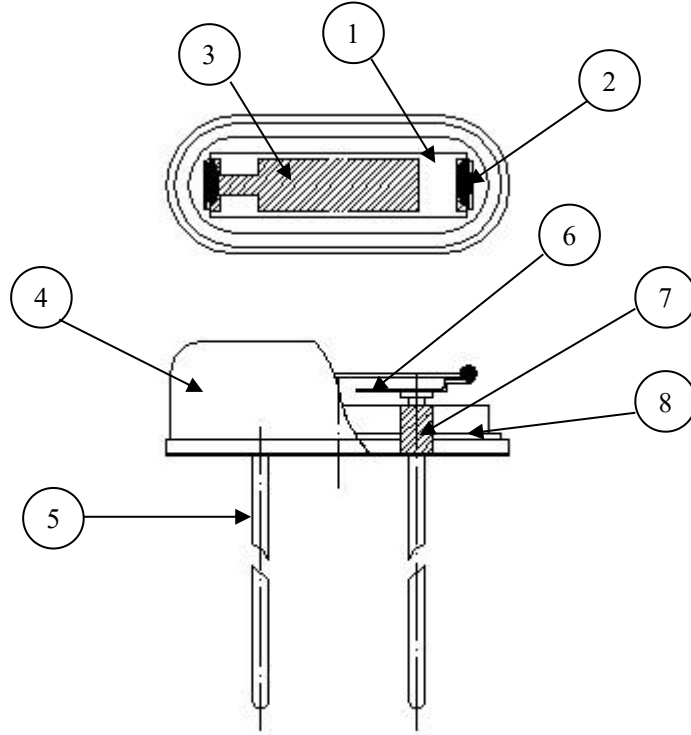

NO.	Product name 部件名称	MATERIALS 材质	QTY 数量	
1	Blank 晶片	SIO2	1	
2	Silver paste 导电胶	3301F	2	
3	Silver 电极	Ag	2	
4	Cover 外壳	Au	1	
5	Lead 引线	Kovar	2	
6	Pin 簧片	C7701	2	
7	GLASS 玻璃珠	GLASS	2	
8	Base 底板	SPCC-SD	1	

Packing Method (包装样式)

1. Packed 200 Pcs in 1 vinyl bag
200PCS一小袋。
2. Packed 10 vinyl bag in 1 box
10小袋一盒。
3. Packed 10 box in 1 carton
10盒一箱
4. There are 20000Pcs in 1 carton
总计20000PCS装一箱
5. Size of carton: 375mm*295mm*203mm
外箱尺寸: 375mm*295mm*203mm
6. Label mode
标签样式
 - A. P/O NO:
 - B. LOT NO:
 - C. HOLDER TYPE.
 - D. FREQUENCY:
 - E. LOAD CAP
 - F. FREQUENCY TOLERANCE
 - G. RESISTANCE
 - H. QUANTITY:

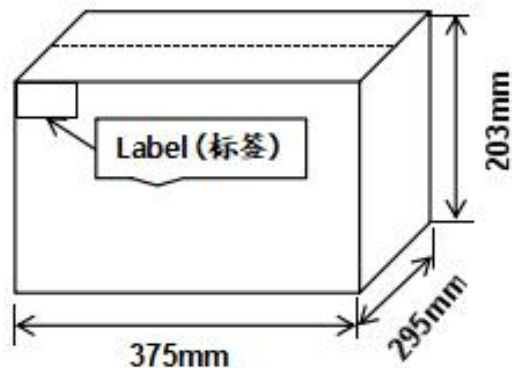

CARTON (外箱)

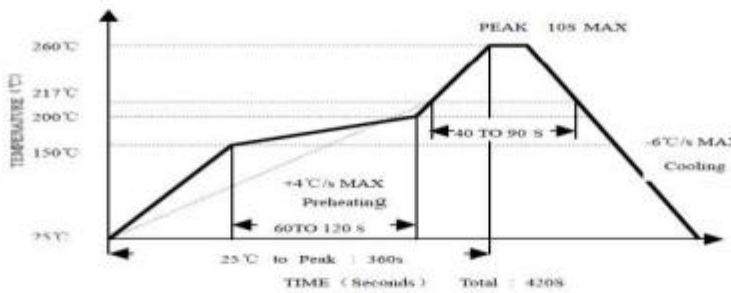
1	Drop 跌落	According to experiment of IEC 68-2-32 method Ed,quartz crystal unit shall be dropped from 75cm height on 3cm hard board for 3 times.	AB
		按IEC 68-2-32试验Ed进行，晶体从75厘米高度自由下落至3厘米硬木板，重复3次。	
2	Reflow 回流焊	Reflow soldering cure see the chart.	A
		回流焊曲线见下图。 	
3	Leakage 气密性	Alcohol press method:quartz crystal unit shall be immersed in the can,and pressed by 0.5kg press for 30min;Then put away press ,and dry it.Quartz crystal unit shall be test insulation resistance by 100V volts d.c for 1 min.	D
		酒精加压法：晶体浸入酒精罐中，加压（压力0.5kg，时间30分钟）；撤去压力后，晾干晶体，测量引线与外壳之间绝缘电阻（100V直流电压，时间1分钟）。	
4	Aging 老化	Quartz crystal unit shall be stored at a temperature 85±2°C for 720±12 hours(30days),and then it shall be subjected to standard atmospheric conditions for 1 hour.	A
		晶体在温度85±2°C中放置720小时（30天）±12小时后，在常温常湿状态下放置1小时后测试。	

Accept Level:

判定标准:

No.	specification 标准
A	Satisfying the electric characteristic; Frequency change is at the range of 5PPM and resistance change is at the range of 5Ω. 电气性能可满足要求：频率变化量在5ppm以内,电阻变化量在5Ω以内。
B	After each test,no visible damage shall be manifested,nor shall the hermetic seal break down 试验后，无机械损伤
C	Dipping in 3 sec.A new uniform coating of solder shall covera minimum of 95% of the surface being immersed. 浸锡时间3秒以内，引线挂锡面积95%以上。
D	Insulation resistance of leads shall be more than 500MΩ(100V DC). 端子之间的绝缘电阻≥500MΩ(100V DC)。

X-ON Electronics

Largest Supplier of Electrical and Electronic Components

Click to view similar products for [Crystals](#) category:

Click to view products by [SST](#) manufacturer:

Other Similar products are found below :

[CX3225GB25000M0PPSZ1](#) [718-13.2-1](#) [7A-40.000MAAE-T](#) [FL2000085](#) [99-BU](#) [9B-15.360MBBK-B](#) [9C-7.680MBBK-T](#) [H10S-12.000-18-EXT-TR](#) [ABC2-6.000MHZ-D4Z-T](#) [ABLS-20.000MHZ-D2-T](#) [ABS071-32.768KHZ-6-T](#) [R38-32.768-12.5-5PPM-NPB](#) [BTD1062E05A-513](#) [21U15A-21.4MHZ](#) [RTX-781DF1-S-20.950](#) [LFXTAL066198Cutt](#) [9C-14.31818MBBK-T](#) [A-11.000MHZ-27](#) [ABL-27.000MHZ-B4Y-T](#) [ABM11-132-24.000MHZ-T3](#) [ABM3B1-25.000MHZ-D2Y-T](#) [SPT2A-.032768B](#) [SPT2A.032768G](#) [LFXTAL065253Cutt](#) [LFXTAL066431Cutt](#) [XT9S20ANA14M7456](#) [XT9SNLANA16M](#) [7A-24.576MBBK-T](#) [7B-30.000MBBK-T](#) [CX2520DB16000H0HPQCC](#) [MMCC2R32.7680KHZ](#) [6504-202-1501](#) [6526-202-1501](#) [ABLS-12.000MHZ-B2Y-T](#) [7A-10.000MBBK-T](#) [SG636PCE-20.000MC](#) [3404](#) [CM315D32768EZFT](#) [C1E-24.000-7-2020-R](#) [C1E-19.200-12-1530-X-R](#) [C1E-16.000-12-1530-X-R](#) [ABM11-16.000MHZ-9-B1U-T](#) [FL5000014](#) [EUCA18-3.1872M](#) [FX0800015](#) [425F35E027M0000](#) [FP0800018](#) [MS3V-T1R-32.768kHz-7pF-20PPM-TA-QC-Au](#) [VXM7-1C1-16M000](#) [MS3V-T1R-32.768kHz-9pF-20PPM-TA-QC-Au](#)