

- Features:
- Non-inductive design
 - Molded body for package uniformity
 - Ideal for pulse-load handling characteristics
 - RoHS compliant / lead-free



Electrical Specifications						
Type / Code	Power Rating (Watts) @ 70°C	Maximum Continuous Working Voltage ⁽¹⁾	Maximum Pulse Voltage	Dielectric Withstanding Voltage	Ohmic Range (Ω) and Tolerance	
					5%	10%
RC14	0.25W	250V	400V	500V	2.2 - 91 K	1 - 5.6 M
RC12	0.5W	350V	700V	700V	1 - 91 K	1 - 22 M

(1) Lesser of \sqrt{PR} or maximum working voltage.

Mechanical Specifications

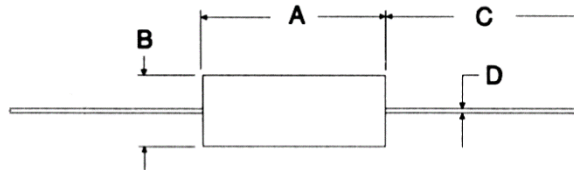

Type / Code	A Body Length	B Body Diameter	C Lead Length (Bulk)	D Lead Diameter	Unit
RC14	0.248 ± 0.028	0.094 ± 0.004	1.181 ± 0.118	0.024 ± 0.002	inches
	6.30 ± 0.70	2.40 ± 0.10	30.00 ± 3.00	0.60 ± 0.05	mm
RC12	0.374 ± 0.031	0.142 ± 0.008	1.102 ± 0.118	0.028 ± 0.003	inches
	9.50 ± 0.80	3.60 ± 0.20	28.00 ± 3.00	0.70 ± 0.07	mm

Power Derating Curve:

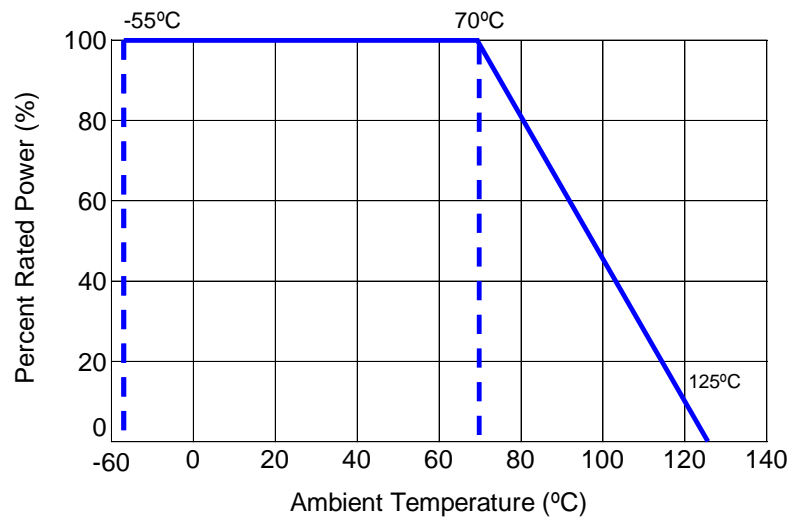

Resistance Temperature Characteristics			
Resistance Range	-55°C	+105°C	Maximum % resistance change from room temperature (+25°C) value
Under 1K	+2 to +5	-4 to -2	
1K to 9.1K	+5 to +9	-5 to -3	
10K to 91K	+8 to +11	-7 to -5	
100K	+10 to +14	-9 to -7	
100K to 910K	+10 to +14	-9 to -7	
1M to 10M	+13 to +20	-14 to -9	

Performance Characteristics (JISC 5201 - 1:1998)		
Test	Test Results	Test Method
Voltage Proof	No breakdown or flashover	V-block method RC 1/4 100 VAC, 60 seconds RC 1/2 500 VAC, 60 seconds
Overload	±2% +0.05Ω No visible damage, legible markings	2.5 times the rated voltage or twice the limiting element voltage, whichever is less. Severe, 5 seconds.
Termination Strength	Tensile: ±2% +0.05Ω. No visible damage Bending: ±2% +0.05Ω. No visible damage Torsion: ±2% +0.05Ω. No visible damage	10N for 5 - 10 seconds 5N, twice 180°C, two rotations
Solderability	In accordance with Clause 4.17.4.5	235°C, 5 seconds
Resistance to Soldering Heat	±3% +0.05Ω No visible damage, legible markings	After immersion into flux, the immersion into solder shall be carried out 4mm from the body at 350°C for 3.5 seconds
Temperature Shock	±2% +0.05Ω No visible damage.	5 cycles between -55°C to 125°C
Climatic Sequence	±10% +0.5Ω	Dry/Damp heat: 12 +12 hour cycle, first cycle Cold/Damp heat: 12 + 12 hour cycle, remaining cycle D.C. load
Damp Test, Steady State	±10% +0.5Ω Insulation resistance: R ≥100M ohm. No visible damage, legible markings	40°C 95% relative humidity for 56 days, test a, b and c of Clause 4.24.2.1
Endurance @ 70°C	±10% +0.5Ω Insulation resistance: R ≥1G ohm. No visible damage.	Rated voltage, 1.5 hours ON, 0.5 hours OFF at 70°C, 1,000 hours
Endurance @ 125°C	±10% +0.5Ω Insulation resistance: R ≥1G ohm. No visible damage.	125°C, no load, 1,000 hours

Operating Temperature Range: -55°C to +125°C

Reliability Test – Load Life in Moisture							
Criteria (%)	Load Ratio P/Pn (%)	Total Testing Time (Hrs)	Number of Fractures (pcs)	Failure Ratio		Average Lifetime (60% reliability level) (Hrs)	
				λ	λCL (60%)		
Δ R/R	±5	0	2.984 x 10 ⁶	6	0.201	0.244	4.098 x 10 ⁵
		20	2.990 x 10 ⁶	4	0.134	0.176	5.682 x 10 ⁵
		60	2.997 x 10 ⁶	2	0.067	0.104	9.615 x 10 ⁵
		100	2.992 x 10 ⁶	3	0.1	0.139	7.194 x 10 ⁵
		Total	1.196 x 10 ⁷	15	0.125	0.138	7.209 x 10 ⁵
	±10	Total	1.2 x 10 ⁷	0	0.0055	0.0077	1.299 x 10 ⁷

Hot Spot Temperature

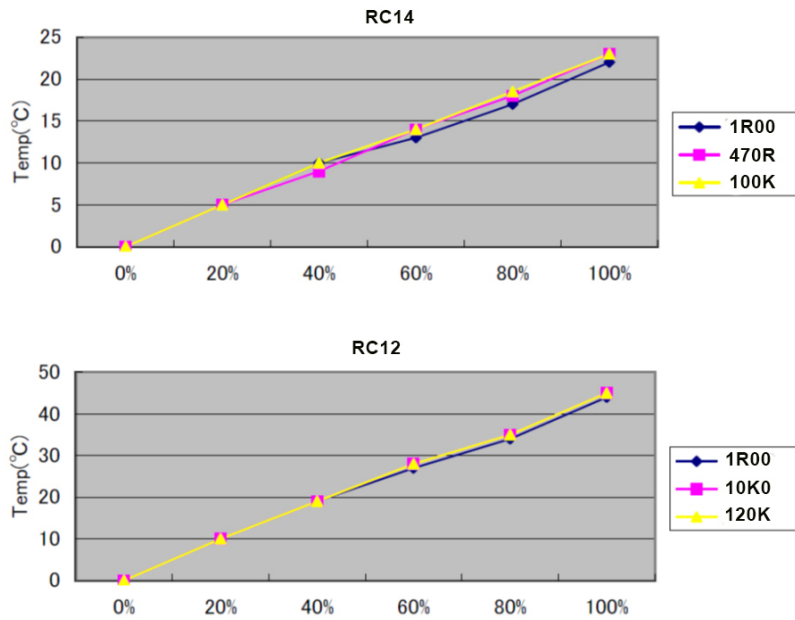

Single Pulse Power Capability

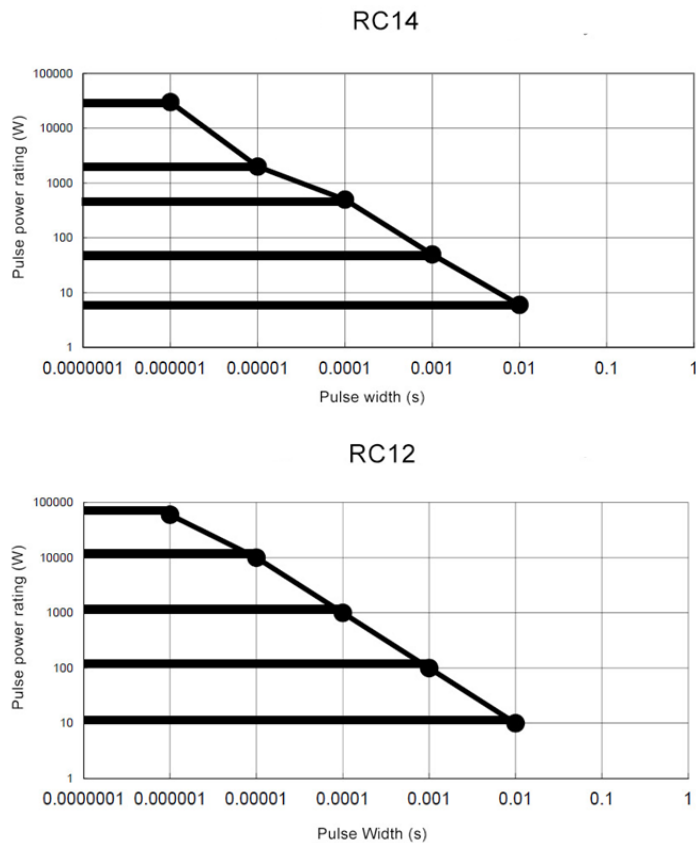

Continuous Pulse Circuit

100 Pulse Data
E: 10kV; C1: 1000pF; R1: 1KΩ; R2: 4MΩ; X: Sample; RS: 15MΩ; 100 times pulse.

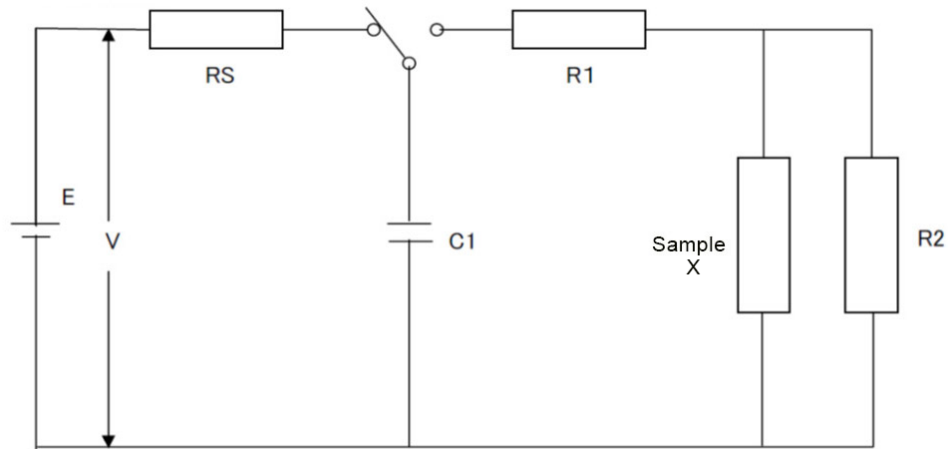

Continuous Pulse Capability

RC14

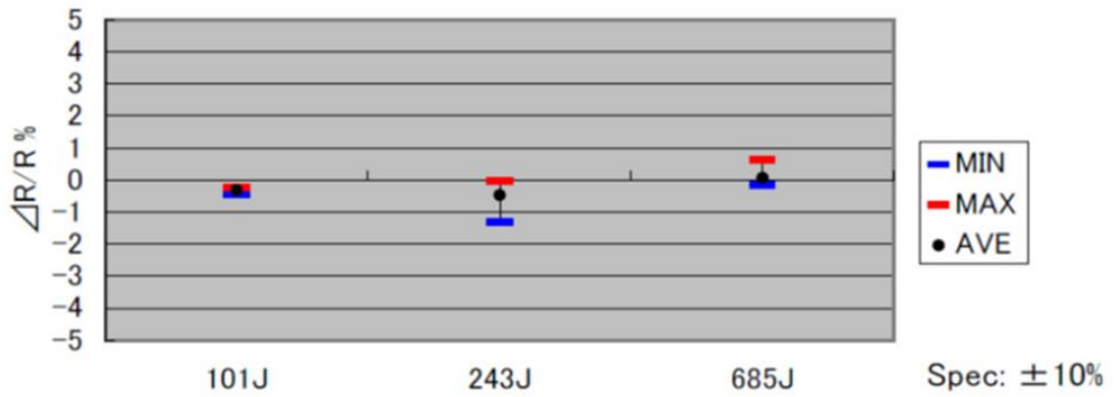

RC12

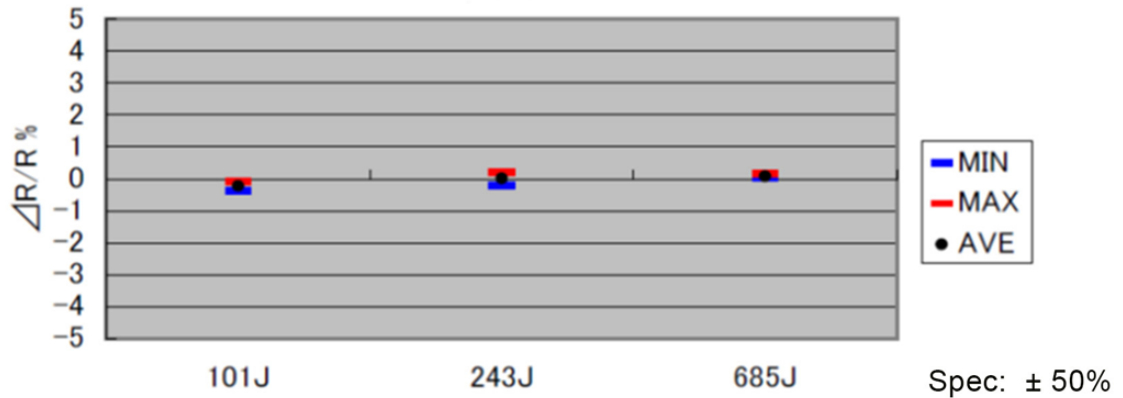

Impedance x Frequency

Equipment: HP4291A Impedance/Material Analyzer

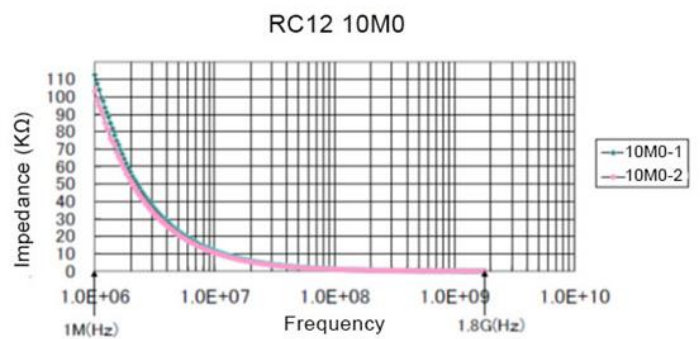
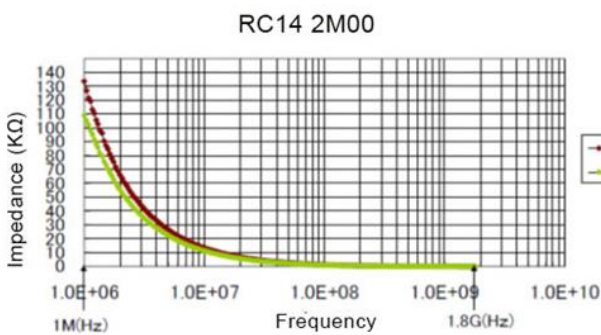
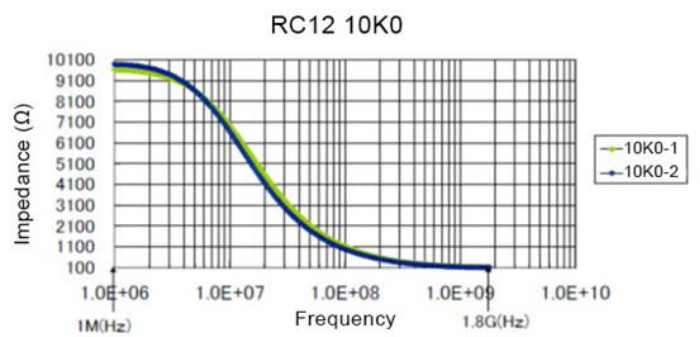
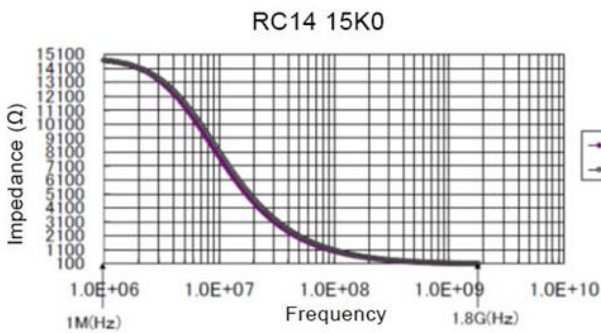
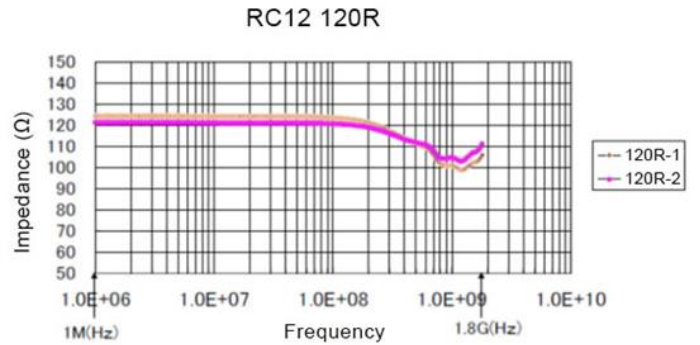
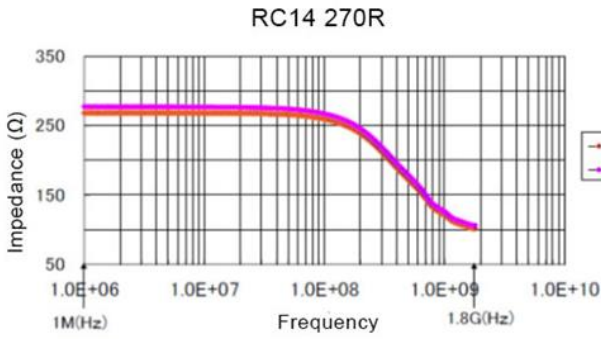

Current Noise

Current Noise Data (Q.T.L.)

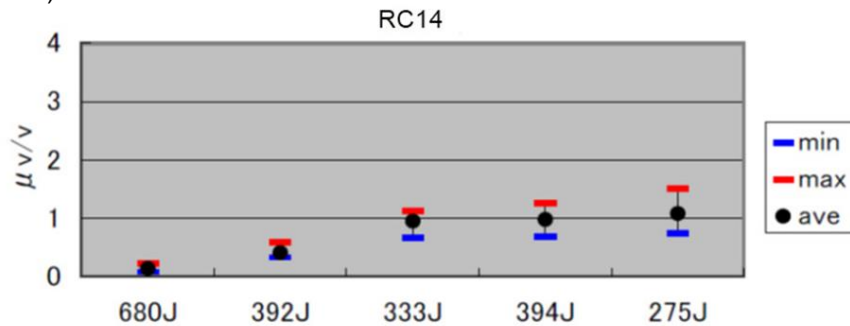

R value	101J	302J	243J	373J	685J
spec ($\mu v/v$)	1	2	3	3	4

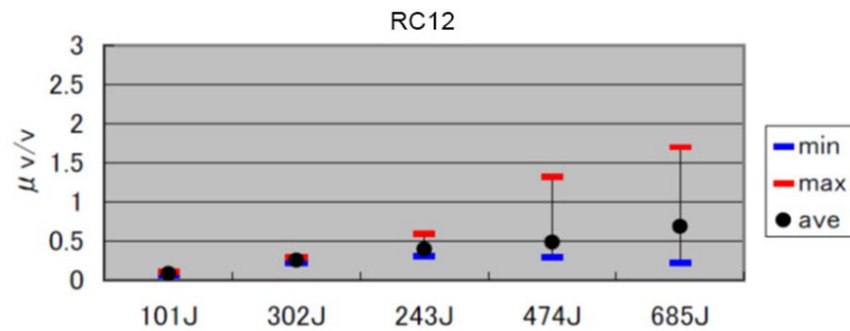

R value	101J	302J	243J	373J	685J
spec ($\mu v/v$)	1	1	2	3	3

Packaging Specifications

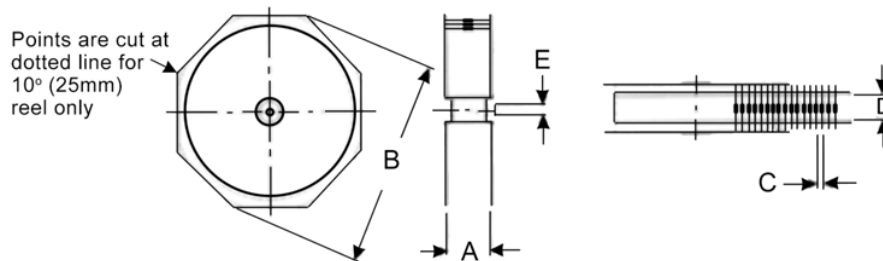

Type / Code	A max	B max	C	D	Tape	Unit
RC14	2.787 70.80	13.504 343.00	0.394 ± 0.020 10.00 ± 0.50	2.063 ± 0.079 52.40 ± 2.00	0.250 6.35	inches mm
RC12	2.756 70.00	13.504 343.00	0.394 ± 0.020 10.00 ± 0.50	2.063 ± 0.079 52.40 ± 2.00	0.250 6.35	inches mm

Technical Guide:

1. Storage Conditions:

- Temperature: 5 to 35°C (40 to 95°F)
- Humidity: 25 – 60% relative humidity
- Term: One year in poly-bag with desiccant. If parts are removed from the poly-bag, they should be used immediately or resealed in the bag.
- Environment: Clean, dry environment, free of corrosive gases

2. Application precautions:

- Lead forming: Forming is recommended at least 2mm of farther from the base of the lead
- Soldering: Soldering is recommended at least 4mm or farther from the base of the lead

3. Washing:

Carbon composition resistors are highly hygroscopic and changes in resistance value can occur if too much moisture is absorbed. For this reason it is recommended not to use water or water-soluble solvents to clean these components. Alcohol or hydrocarbon solvents are recommended for rinsing.

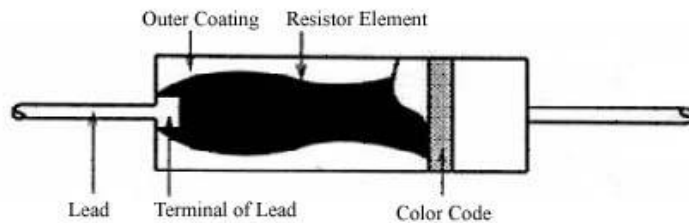

4. Soldering Recommendations:

Note: The conditions shown below are for reference. Please perform a mounting evaluation to assure compatibility.

a. Flow soldering (recommended profile for Sn and Sn/Pb solders)

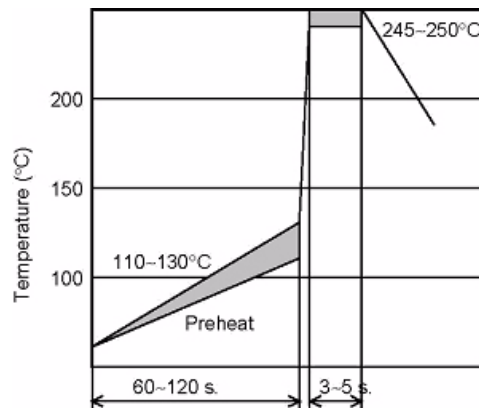

b. Soldering iron (recommended for Sn and Sn/Pb solders)

- Temperature of soldering tip: 300°C, duration: 10 sec. max.
- Temperature of soldering tip: 350°C, duration: 3 sec. max.

Other:

1. Evaluate and confirm the compatibility of your assembly process with this product.
2. Refer to the catalog, the product news, and the specifications for details on the RC series resistors.
3. If you have any questions, please contact our sales staff.

Characteristic Data

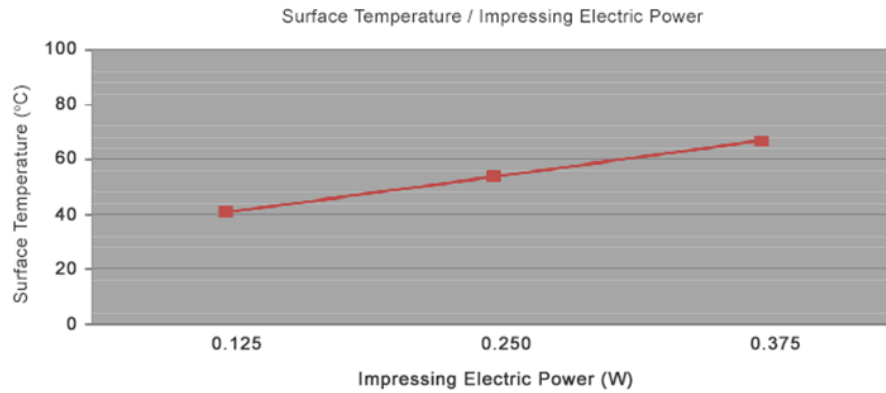

Impressing Electric Power (W)	Surface Temperature (°C)
0.125	40.7
0.250	53.6
0.375	66.8

Characteristic Data

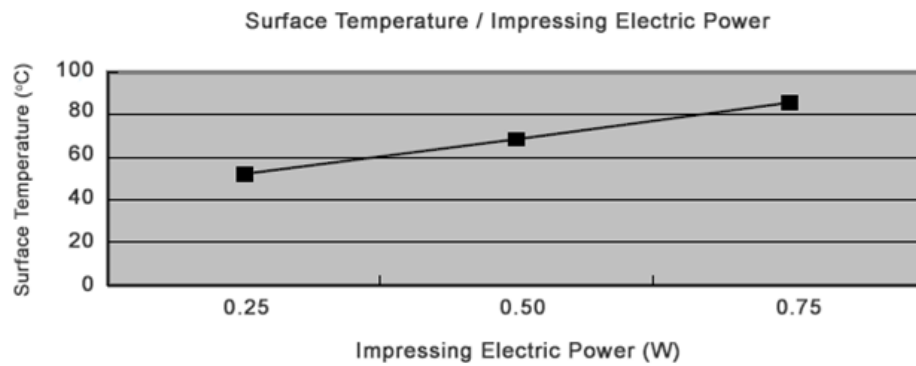

Impressing Electric Power (W)	Surface Temperature (°C)
0.25	52.3
0.50	68.5
0.75	85.6

Measurement Condition:

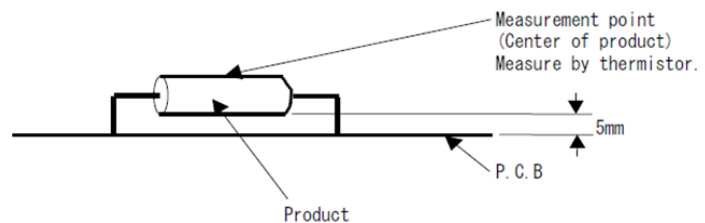

RoHS Compliance

Stackpole Electronics has joined the worldwide effort to reduce the amount of lead in electronic components and to meet the various regulatory requirements now prevalent, such as the European Union’s directive regarding “Restrictions on Hazardous Substances” (RoHS 3). As part of this ongoing program, we periodically update this document with the status regarding the availability of our compliant components. All our standard part numbers are compliant to EU Directive 2011/65/EU of the European Parliament as amended by Directive (EU) 2015/863/EU as regards the list of restricted substances.

RoHS Compliance Status						
Standard Product Series	Description	Package / Termination Type	Standard Series RoHS Compliant	Lead-Free Termination Composition	Lead-Free Mfg. Effective Date (Std Product Series)	Lead-Free Effective Date Code (YY/WW)
RC	Carbon Composition Leded Resistor	Axial	YES	100% Matte Sn	Jan-86	86/01

“Conflict Metals” Commitment

We at Stackpole Electronics, Inc. are joined with our industry in opposing the use of metals mined in the “conflict region” of the eastern Democratic Republic of the Congo (DRC) in our products. Recognizing that the supply chain for metals used in the electronics industry is very complex, we work closely with our own suppliers to verify to the extent possible that the materials and products we supply do not contain metals sourced from this conflict region. As such, we are in compliance with the requirements of Dodd-Frank Act regarding Conflict Minerals.

Compliance to “REACH”

We certify that all passive components supplied by Stackpole Electronics, Inc. are SVHC (Substances of Very High Concern) free and compliant with the requirements of EU Directive 1907/2006/EC, “The Registration, Evaluation, Authorization and Restriction of Chemicals”, otherwise referred to as REACH. Contact us for complete list of REACH Substance Candidate List.

Environmental Policy

It is the policy of Stackpole Electronics, Inc. (SEI) to protect the environment in all localities in which we operate. We continually strive to improve our effect on the environment. We observe all applicable laws and regulations regarding the protection of our environment and all requests related to the environment to which we have agreed. We are committed to the prevention of all forms of pollution.

How to Order

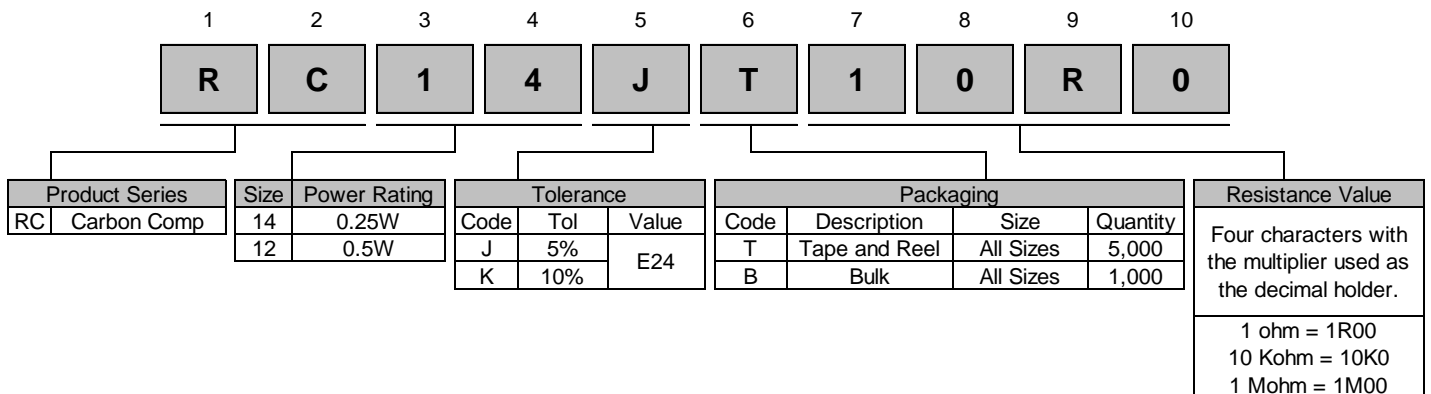

X-ON Electronics

Largest Supplier of Electrical and Electronic Components

Click to view similar products for [Metal Film Resistors - Through Hole](#) category:

Click to view products by [Stackpole](#) manufacturer:

Other Similar products are found below :

[FRN25J330R](#) [FRN50J1R0S](#) [H4100RBYA](#) [H415RBZA](#) [H41K1BYA](#) [H41K5BYA](#) [H41M0BDA](#) [H420R5BCA](#) [H421R5BZA](#) [H4221RBYA](#)
[H424K3BDA](#) [H442K2BDA](#) [H45K62BZA](#) [H4634RBZA](#) [H473R2BZA](#) [H4931KBZA](#) [H8160KFDA](#) [H8274KBZA](#) [H82K0FDA](#) [H82K0FZA](#)
[H87K5DYA](#) [RLR05C6201GS](#) [HR01623J](#) [HR01682J](#) [270-1.69M-RC](#) [LR0204F110R](#) [LR0204F18R](#) [LR0204F20K](#) [LR0204F20R](#)
[LR0204F510R](#) [LR1F121R](#) [LR1F133K](#) [LR1F383R](#) [LR1F3K01](#) [LR1F4K75](#) [LR2F330RJIT](#) [LR2F51R](#) [LR2F910R](#) [ERX-2SZJR20E](#)
[SQMR74K7J](#) [FMF-25FTF52-100K](#) [FRN50J100RS](#) [FRN50J470RS](#) [H4100RBZA](#) [H414R3BZA](#) [H415KBYA](#) [H4174KBZA](#) [H4174RBDA](#)
[H41K21BYA](#) [H41K43BDA](#)