

- Features:
- Handles 2W of power
  - Resistances from 0.1Ω to 1MΩ
  - RoHS compliant and halogen-free
  - TCR of ± 100 ppm/°C
  - 1% and 5% tolerances
  - Runs significantly cooler than standard thick film 2512 chip

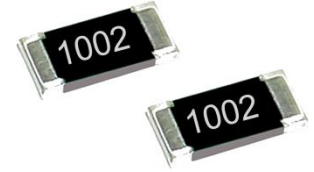

Electrical Specifications						
Type / Code	Package Type	Power Rating (Watts) @ 70°C	Maximum Working Voltage <sup>(1)</sup>	Maximum Overload Voltage	Resistance Temperature Coefficient	Ohmic Range (Ω) and Tolerance
RHC2512	2512	2W	200V	400V	±100 ppm/°C	0.1 - 1M

Note: (1) Lesser of  $\sqrt{P \cdot R}$  or maximum working voltage

Please refer to the High-Power Resistor Application Note (page 3) for more information on designing and implementing high power resistor types.

Mechanical Specifications						
Type / Code	L Body Length	W Body Width	H Body Height	a Top Termination	b Bottom Termination	Unit
RHC2512	0.248 ± 0.008	0.126 ± 0.008	0.024 ± 0.004	0.028 ± 0.008	0.087 ± 0.008	inches
	6.30 ± 0.20	3.20 ± 0.20	0.60 ± 0.10	0.70 ± 0.20	2.20 ± 0.20	mm

Recommended Pad Layout				
Type / Code	L Total Length	W Total Width	D Pad Depth	Unit
RHC2512	0.315	0.138	0.118	inches
	8.00	3.50	3.00	mm

Performance Characteristics	
Test	Typical
Moisture Resistance	±1% + 0.05Ω for <10Ω and ±1% for ≥10Ω
Load Life	
Resistance to Soldering	
Temperature Cycling	
Thermal Shock	
Short Time Overload	
Insulation Resistance	≥1MΩ

Operating Temperature Range: -55°C to +155°C

**Power Derating Curve:**

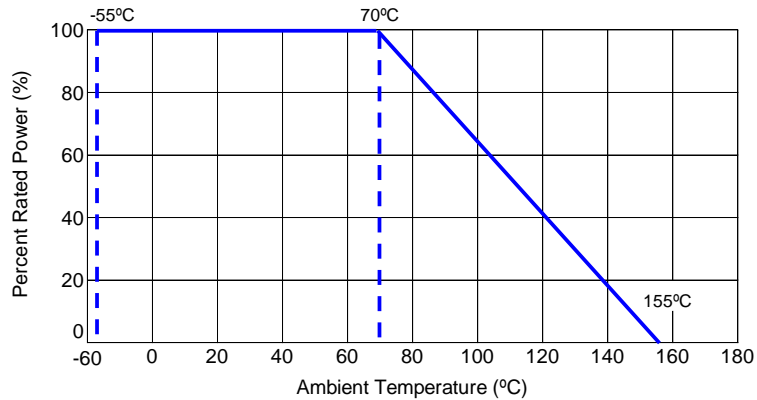

**Hot Spot and Terminal Temp.:**

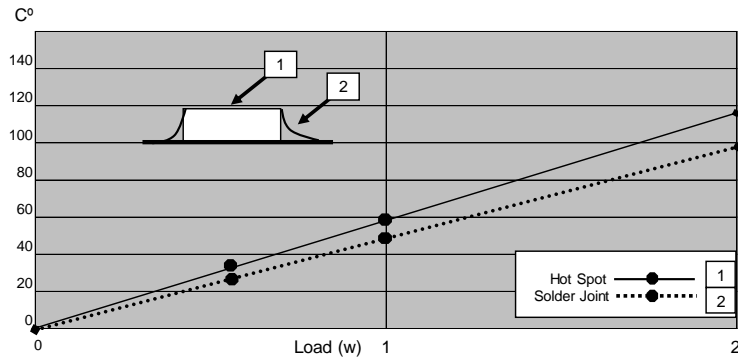

**Repeated Overload:**

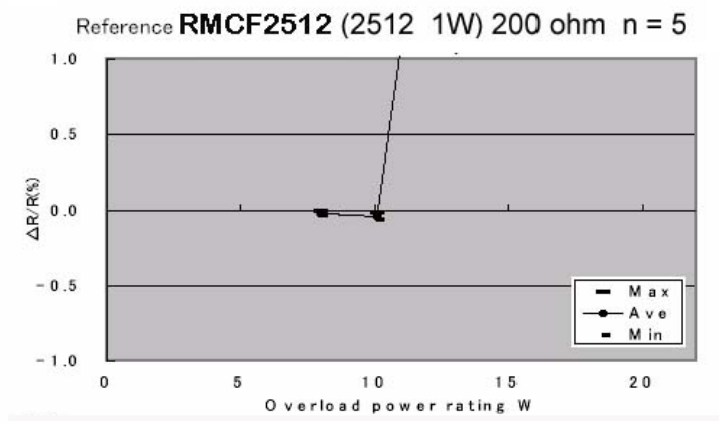
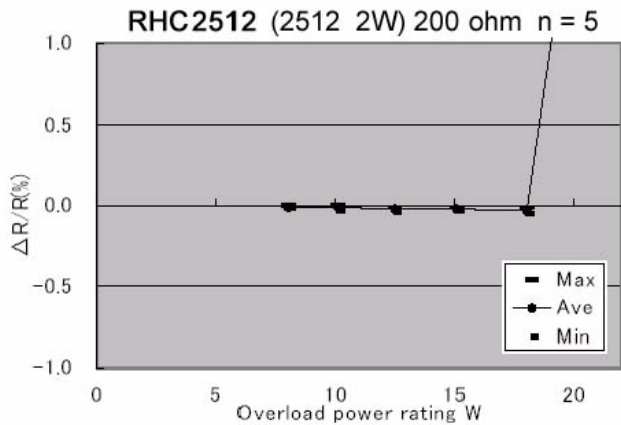

**Test condition:**

Voltage (Power): 2.0, 2.25, 2.5, 2.75, 3.0, 3.25 times of rated voltage. (8W, 10.1W, 12.5W, 15.1W, 18W, 21.1W)

**Applied time:**

Each voltage 5 seconds.

As a reference test, the RMC was tested with the same rated voltage and testing substrate.

**Packaging Specifications – Embossed Plastic Tape**

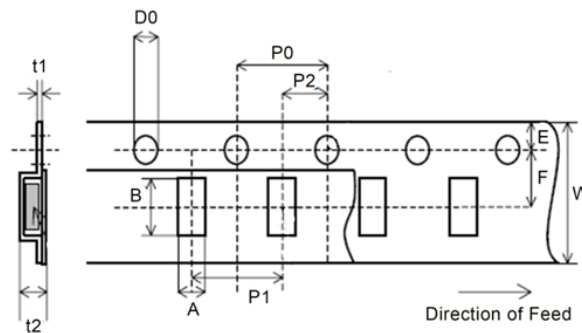

Type	A	B	W	F	E	P1	Unit
RHC2512	0.134 ± 0.004 3.40 ± 0.10	0.260 ± 0.004 6.60 ± 0.10	0.472 ± 0.008 12.00 ± 0.20	0.217 ± 0.002 5.50 ± 0.05	0.069 ± 0.004 1.75 ± 0.10	0.157 ± 0.004 4.00 ± 0.10	Inches mm
Type	P2	P0	D0	t1	t2	Unit	
RHC2512	0.079 ± 0.002 2.00 ± 0.05	0.157 ± 0.004 4.00 ± 0.10	0.061 ± 0.002 1.55 ± 0.05	0.010 ± 0.002 0.25 ± 0.05	0.039 ± 0.004 1.00 ± 0.10	Inches mm	

**Reel Specifications**

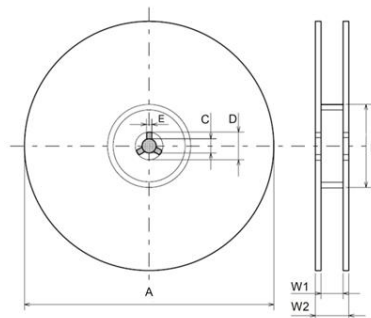

Type	A	B	C	D	E	W1	W2	Unit
RHC2512	7.087 ± 0.118 180.00 ± 3.00	2.362 ± 0.039 60.00 ± 1.00	0.512 ± 0.008 13.00 ± 0.20	0.827 ± 0.031 21.00 ± 0.80	0.079 ± 0.020 2.00 ± 0.50	0.512 ± 0.012 13.00 ± 0.30	0.606 ± 0.039 15.40 ± 1.00	Inches mm

**High Power Chip Resistors and Thermal Management**

Stackpole has developed several surface mount resistor series in addition to our current sense resistors, which have had higher power ratings than standard resistor chips. This has caused some uncertainty and even confusion by users as to how to reliably use these resistors at the higher power ratings in their designs.

The data sheets for the RHC, RMCP, RNCP, CSR, CSRN, CSRf, CSS, and CSSH state that the rated power assumes an ambient temperature of no more than 100 degrees C for the CSS / CSSH series and 70°C for all other high power resistor series. In addition, IPC and UL best practices dictate that the combined temperature on any resistor due to power dissipated and ambient air shall be no more than 105°C. At first glance this wouldn't seem too difficult, however the graph below shows typical heat rise for the CSR ½ 100 milliohm at full rated power. The heat rise for the RMCP and RNCP would be similar. The RHC with its unique materials, design, and processes would have less heat rise and therefore would be easier to implement for any given customer.

**CSR1206 100m Surface Temp Rise**

Test equipment:  
Chroma Programmable DC Power Supply  
YF-162 Type-K thermometer

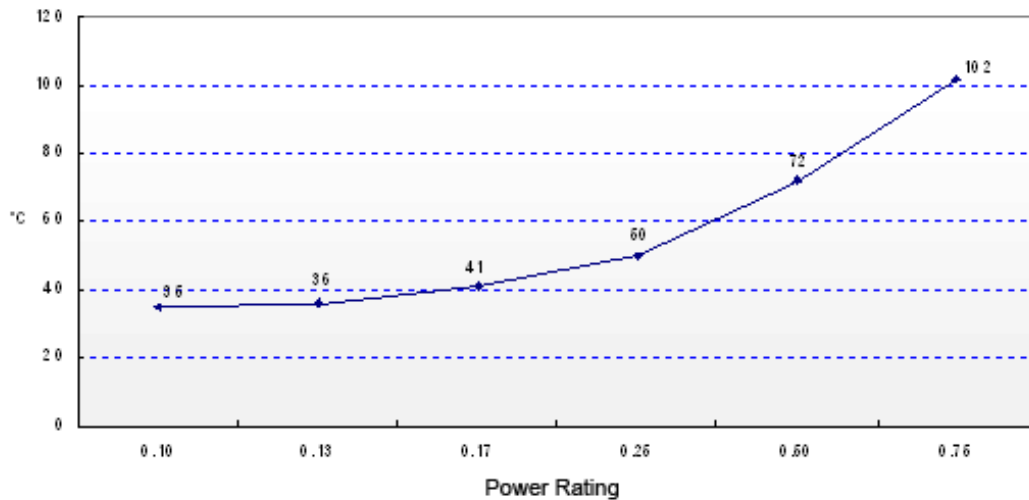

The 102°C heat rise shown here would indicate there will be additional thermal reduction techniques needed to keep this part under 105°C total hot spot temperature if this part is to be used at 0.75 watts of power. However, this same part at the usual power rating for this size would have a heat rise of around 72°C. This additional heat rise may be dealt with using wider conductor traces, larger solder pads and land patterns under the solder mask, heavier copper in the conductors, via through PCB, air movement, and heat sinks, among many other techniques. Because of the variety of methods customers can use to lower the effective heat rise of the circuit, resistor manufacturers simply specify power ratings with the limitations on ambient air temperature and total hot spot temperatures and leave the details of how to best accomplish this to the design engineers. Design guidelines for products in various market segments can vary widely so it would be unnecessarily constraining for a resistor manufacturer to recommend the use of any of these methods over another.

Note: The final resistance value can be affected by the board layout and assembly process, especially the size of the mounting pads and the amount of solder used. This is especially notable for resistance values  $\leq 50\text{m}\Omega$ . This should be taken into account when designing.

**RoHS Compliance**

Stackpole Electronics has joined the worldwide effort to reduce the amount of lead in electronic components and to meet the various regulatory requirements now prevalent, such as the European Union’s directive regarding “Restrictions on Hazardous Substances” (RoHS 3). As part of this ongoing program, we periodically update this document with the status regarding the availability of our compliant components. All our standard part numbers are compliant to EU Directive 2011/65/EU of the European Parliament as amended by Directive (EU) 2015/863/EU as regards the list of restricted substances.

RoHS Compliance Status						
Standard Product Series	Description	Package / Termination Type	Standard Series RoHS Compliant	Lead-Free Termination Composition	Lead-Free Mfg. Effective Date (Std Product Series)	Lead-Free Effective Date Code (YY/WW)
RHC	High Power Thick Film Surface Mount Chip Resistor	SMD	YES(1)	100% Matte Sn over Ni	Jul-04	04/27

Note (1): RoHS Compliant by means of exemption 7c-1.

**“Conflict Metals” Commitment**

We at Stackpole Electronics, Inc. are joined with our industry in opposing the use of metals mined in the “conflict region” of the eastern Democratic Republic of the Congo (DRC) in our products. Recognizing that the supply chain for metals used in the electronics industry is very complex, we work closely with our own suppliers to verify to the extent possible that the materials and products we supply do not contain metals sourced from this conflict region. As such, we are in compliance with the requirements of Dodd-Frank Act regarding Conflict Minerals.

**Compliance to “REACH”**

We certify that all passive components supplied by Stackpole Electronics, Inc. are SVHC (Substances of Very High Concern) free and compliant with the requirements of EU Directive 1907/2006/EC, “The Registration, Evaluation, Authorization and Restriction of Chemicals”, otherwise referred to as REACH. Contact us for complete list of REACH Substance Candidate List.

**Environmental Policy**

It is the policy of Stackpole Electronics, Inc. (SEI) to protect the environment in all localities in which we operate. We continually strive to improve our effect on the environment. We observe all applicable laws and regulations regarding the protection of our environment and all requests related to the environment to which we have agreed. We are committed to the prevention of all forms of pollution.

**How to Order**

1	2	3	4	5	6	7	8	9	10	11	12	13
<b>R</b>	<b>H</b>	<b>C</b>	<b>2</b>	<b>5</b>	<b>1</b>	<b>2</b>	<b>F</b>	<b>T</b>	<b>1</b>	<b>0</b>	<b>K</b>	<b>0</b>

Product Series		Size		Tolerance			Packaging				Resistance Value	
Series	Description	Code	Power Rating	Code	Tol	Value	Code	Description	Size	Quantity	Four characters with the multiplier used as the decimal holder.  0.1 ohm = R100 4.75 ohm = 4R75 10.2 Kohm = 10K2 1 Mohm = 1M00	
RHC	High Power	2512	2W	F	1%	E96, E24	T	7" Reel Plastic Tape	2512	4,000		
				J	5%	E24						

## X-ON Electronics

Largest Supplier of Electrical and Electronic Components

*Click to view similar products for* [Current Sense Resistors - SMD category:](#)

*Click to view products by* [Stackpole manufacturer:](#)

Other Similar products are found below :

[5112](#) [65709-330JE](#) [PF2512FKF7W0R007L](#) [PR2512FKF7W0R003L](#) [PR2512FKF7W0R005L](#) [RCWL0603R500JNEA](#) [ERJ-3BQF1R1V](#) [ERJ-L14UJ42MU](#) [2-2176088-5](#) [PF2512FKF7W0R006L](#) [PF2512FKF7W0R033L](#) [2-2176089-4](#) [CD2015FC-0.10-1%](#) [PR2512FKF7W0R004L](#) [CGSSL1R01J](#) [CGSSL1R047J](#) [RC1005F124CS](#) [RCWE2512R110FKEA](#) [RCWL0805R330JNEA](#) [RL73H3AR47FTE](#) [RL73K3AR56JTDF](#) [RL7520WT-R001-F](#) [RL7520WT-R009-G](#) [RL7520WT-R020-F](#) [RLP73N1ER43JTD](#) [TL3AR01FTDG](#) [TLR3A20DR0005FTDG](#) [LRC-LR2512LF-01-R820J](#) [ERJ-3BQF4R3V](#) [ERJ-L14UF68MU](#) [TLR3A20DR001FTDG](#) [TLR3A30ER0005FTDG](#) [WR06X104JGLJ](#) [RLP73K1ER82JTD](#) [TL2BR01F](#) [TLR3A20DR01FTDG](#) [WSR3R0600FEA32](#) [ERJ-14BQF1R6U](#) [ERJ-14BQJR30U](#) [SP1220RJT](#) [SP1R12J](#) [ERJ-14BQF6R2U](#) [RL7520WT-R039-G](#) [PF1206FRF7W0R02L](#) [RL7520WT-R002-F](#) [RL7520WT-R047-F](#) [RLP73N2BR068FTDF](#) [RL7520WT-R005-F](#) [RCWE2512R220FKEA](#) [RCWE120625L0FMEA](#)