

Dimensions mm[inch]
tolerances according to DIN ISO 2768-m
Toleranzen gem. DIN ISO 2768-m

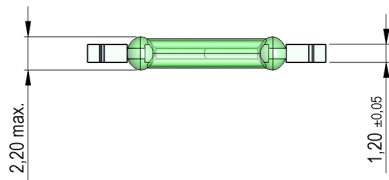

Isometric
Scale 2:1
Maßstab 2:1

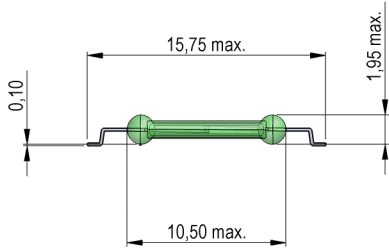
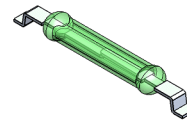

Recommended PCB Pad Layout

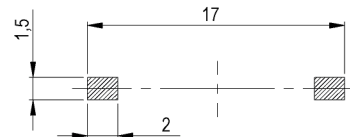

Solder Reflow Profile

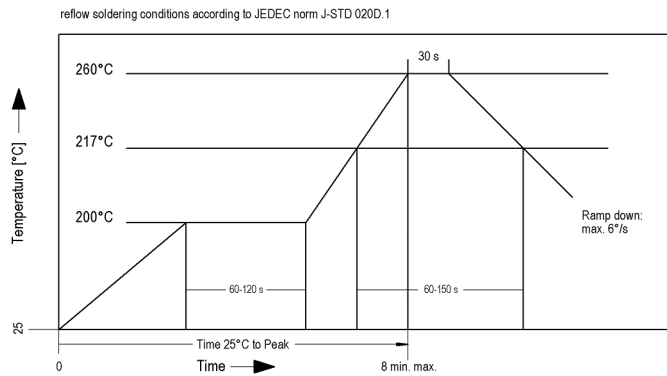

Packaging

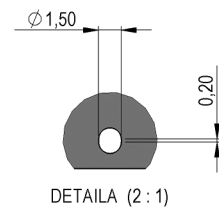
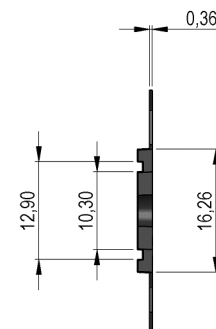
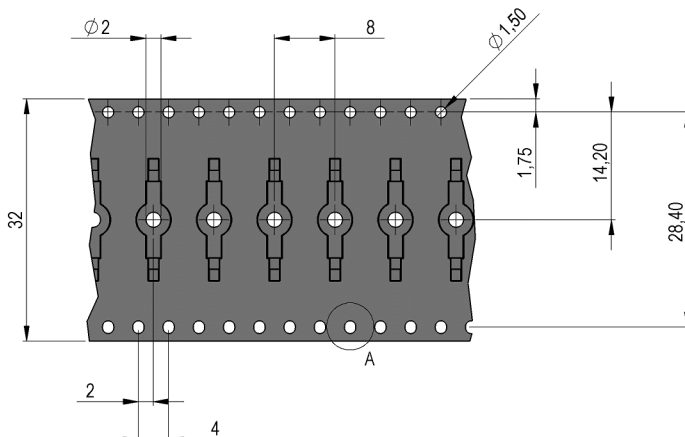



Europe: +49 / 7731 8399 0 | Email: info@standexmeder.com
 USA: +1 / 508 295 0771 | Email: salesusa@standexmeder.com
 Asia: +852 / 2955 1682 | Email: salesasia@standexmeder.com

Item No.:
9231350022
 Item:
MK23-35-B-2

Magnetic properties	Conditions	Min	Typ	Max	Unit
Pull-In	at 20°C	29		55	
Test equipment		KMS-11 + AP51			
Pull-In in milliTesla (modified conta	MS150 - phys. caused tolerance +/- 0,1mT	1,3		2,3	mT
Test equipment		MS-150			

Contact data 35	Conditions	Min	Typ	Max	Unit
Contact - No.		35			
Contact-form		A - NO			
Contact rating	Any DC combination of V & A not to exceed their individual max.'s			15	W
Switching voltage (> 9 AT)	DC or Peak AC			200	V
Switching current	DC or Peak AC			1	A
Carry current	DC or Peak AC			1,25	A
Contact resistance static	Measured with 40% overdrive Start Value			150	mOhm
Breakdown voltage (10-30 AT)	according to IEC 255-5	220			VDC

Special Product Data	Conditions	Min	Typ	Max	Unit
Approval					

Environmental data	Conditions	Min	Typ	Max	Unit
Shock	1/2 sine wave duration 11ms			30	g
Vibration	from 10 - 2000 Hz			20	g
Operating temperature		-40		130	°C
Storage temperature		-55		130	°C
Washability		fully sealed			

Modifications in the sense of technical progress are reserved

Designed at: 17.04.07 Designed by: THAUKE
 Last Change at: 28.05.15 Last Change by: THAUKE

Approval at: 20.04.07 Approval by: JHEYDER
 Approval at: 28.05.15 Approval by: JHEYDER

Version: 12

X-ON Electronics

Largest Supplier of Electrical and Electronic Components

Click to view similar products for [Proximity Sensors](#) category:

Click to view products by [Standexmeder](#) manufacturer:

Other Similar products are found below :

[01.001.5653.1](#) [70.340.1028.0](#) [70.360.2428.0](#) [70.364.4828.0](#) [70.810.1053.0](#) [72.360.1628.0](#) [73.363.6428.0](#) [8027AL20NL2CPXX](#) [FYCC8E1-2](#)
[9221350022](#) [922AA2W-A9P-L](#) [PLS2](#) [GL-12F-C2.5X10\(LOT3\)](#) [972AB2XM-A3N-L](#) [972AB3XM-A3P-L](#) [PS3251](#) [980659-1](#) [QT-12](#) [E2E2-](#)
[X5M41-M4](#) [E2E-X14MD1-G](#) [E2E-X2D1-G](#) [E2EX2ME2N](#) [E2EX3D1SM1N](#) [E2E-X4MD1-G](#) [E2E-X5E1-5M-N](#) [E2E-X5Y2-N](#) [E2E-X7D1-](#)
[M1J-T-0.3M-N](#) [E2FMX1R5D12M](#) [E2K-F10MC1](#) [5M](#) [EH-302](#) [EI3010TBOP](#) [EI5515NPAP](#) [MS605AU](#) [EP175-32000](#) [BSA-08-25-08](#)
[IFRM04N35B1/L](#) [IFRM04P1513/S35L](#) [IFRM06P1703/S35L](#) [IFRM08P1501/S35L](#) [IFRM12N17G3/L](#) [IFRM12P17G3/L](#) [IFRM12P3502/L](#)
[IFRM12P37G1/S14L](#) [ILFK12E9189/I02](#) [ILFK12E9193/I02](#) [IMM2582C](#) [OISN-013](#) [25.161.3253.0](#) [25.332.0653.1](#) [25.352.0653.0](#)