

DOSEMI

IGBT

DG75X12T2

1200V/75A IGBT with Diode

General Description

DOSEMI IGBT Power Discrete provides ultra low conduction loss as well as low switching loss. They are designed for the applications such as general inverters and UPS.

Features

- Low $V_{CE(sat)}$ Trench IGBT technology
- 10 μ s short circuit capability
- Low switching loss
- Maximum junction temperature 175°C
- $V_{CE(sat)}$ with positive temperature coefficient
- Fast & soft reverse recovery anti-parallel FWD
- Lead free package

Typical Applications

- Inverter for motor drive
- AC and DC servo drive amplifier
- Uninterruptible power supply

Equivalent Circuit Schematic

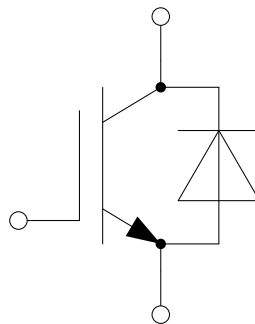

Absolute Maximum Ratings $T_C=25^{\circ}\text{C}$ unless otherwise noted**IGBT**

Symbol	Description	Values	Unit
V_{CES}	Collector-Emitter Voltage	1200	V
V_{GES}	Gate-Emitter Voltage	± 20	V
I_C	Collector Current @ $T_C=25^{\circ}\text{C}$	150	A
	@ $T_C=137^{\circ}\text{C}$	75	
I_{CM}	Pulsed Collector Current t_p limited by T_{jmax}	225	A
P_D	Maximum Power Dissipation @ $T_j=175^{\circ}\text{C}$	852	W

Diode

Symbol	Description	Values	Unit
V_{RRM}	Repetitive Peak Reverse Voltage	1200	V
I_F	Diode Continuous Forward Current	75	A
I_{FM}	Pulsed Collector Current t_p limited by T_{jmax}	225	A

Discrete

Symbol	Description	Values	Unit
T_{jop}	Operating Junction Temperature	-40 to +175	$^{\circ}\text{C}$
T_{STG}	Storage Temperature Range	-55 to +150	$^{\circ}\text{C}$
T_S	Soldering Temperature, 1.6mm from case for 10s	260	$^{\circ}\text{C}$

IGBT Characteristics $T_c=25^\circ\text{C}$ unless otherwise noted

Symbol	Parameter	Test Conditions	Min.	Typ.	Max.	Unit	
$V_{CE(sat)}$	Collector to Emitter Saturation Voltage	$I_C=75\text{A}, V_{GE}=15\text{V}, T_j=25^\circ\text{C}$		1.75	2.20	V	
		$I_C=75\text{A}, V_{GE}=15\text{V}, T_j=150^\circ\text{C}$		2.00			
		$I_C=75\text{A}, V_{GE}=15\text{V}, T_j=175^\circ\text{C}$		2.20			
$V_{GE(th)}$	Gate-Emitter Threshold Voltage	$I_C=2.72\text{mA}, V_{CE}=V_{GE}, T_j=25^\circ\text{C}$	5.6	6.2	6.8	V	
I_{CES}	Collector Cut-Off Current	$V_{CE}=V_{CES}, V_{GE}=0\text{V}, T_j=25^\circ\text{C}$			250	μA	
I_{GES}	Gate-Emitter Leakage Current	$V_{GE}=V_{GES}, V_{CE}=0\text{V}, T_j=25^\circ\text{C}$			100	nA	
R_{Gint}	Internal Gate Resistance			2.0		Ω	
C_{ies}	Input Capacitance	$V_{CE}=25\text{V}, f=100\text{kHz}, V_{GE}=0\text{V}$		6.59		nF	
C_{res}	Reverse Transfer Capacitance				0.19		nF
Q_G	Gate Charge	$V_{GE}=-15\dots+15\text{V}$		0.49		μC	
$t_{d(on)}$	Turn-On Delay Time	$V_{CC}=600\text{V}, I_C=75\text{A}, R_G=4.7\Omega, V_{GE}=\pm 15\text{V}, L_S=40\text{nH}, T_j=25^\circ\text{C}$		47		ns	
t_r	Rise Time			117		ns	
$t_{d(off)}$	Turn-Off Delay Time			157		ns	
t_f	Fall Time			212		ns	
E_{on}	Turn-On Switching Loss			9.91		mJ	
E_{off}	Turn-Off Switching Loss			4.30		mJ	
$t_{d(on)}$	Turn-On Delay Time		$V_{CC}=600\text{V}, I_C=75\text{A}, R_G=4.7\Omega, V_{GE}=\pm 15\text{V}, L_S=40\text{nH}, T_j=150^\circ\text{C}$		52		ns
t_r	Rise Time				109		ns
$t_{d(off)}$	Turn-Off Delay Time				203		ns
t_f	Fall Time				314		ns
E_{on}	Turn-On Switching Loss			13.0		mJ	
E_{off}	Turn-Off Switching Loss			6.39		mJ	
$t_{d(on)}$	Turn-On Delay Time	$V_{CC}=600\text{V}, I_C=75\text{A}, R_G=4.7\Omega, V_{GE}=\pm 15\text{V}, L_S=40\text{nH}, T_j=175^\circ\text{C}$			53		ns
t_r	Rise Time				110		ns
$t_{d(off)}$	Turn-Off Delay Time				235		ns
t_f	Fall Time				324		ns
E_{on}	Turn-On Switching Loss			14.8		mJ	
E_{off}	Turn-Off Switching Loss			6.67		mJ	
I_{SC}	SC Data		$t_p \leq 10\mu\text{s}, V_{GE}=15\text{V}, T_j=175^\circ\text{C}, V_{CC}=800\text{V}, V_{CEM} \leq 1200\text{V}$		300		A

Diode Characteristics $T_C=25^\circ\text{C}$ unless otherwise noted

Symbol	Parameter	Test Conditions	Min.	Typ.	Max.	Unit
V_F	Diode Forward Voltage	$I_F=75\text{A}, V_{GE}=0\text{V}, T_j=25^\circ\text{C}$		2.15	2.60	V
		$I_F=75\text{A}, V_{GE}=0\text{V}, T_j=150^\circ\text{C}$		2.15		
		$I_F=75\text{A}, V_{GE}=0\text{V}, T_j=175^\circ\text{C}$		2.15		
t_{rr}	Diode Reverse Recovery Time	$V_R=600\text{V}, I_F=75\text{A},$ $-di/dt=350\text{A}/\mu\text{s}, V_{GE}=-15\text{V},$ $L_S=40\text{nH},$ $T_j=25^\circ\text{C}$		239		ns
Q_r	Recovered Charge			2.87		μC
I_{RM}	Peak Reverse Recovery Current			19.5		A
E_{rec}	Reverse Recovery Energy			0.76		mJ
t_{rr}	Diode Reverse Recovery Time	$V_R=600\text{V}, I_F=75\text{A},$ $-di/dt=400\text{A}/\mu\text{s}, V_{GE}=-15\text{V},$ $L_S=40\text{nH},$ $T_j=150^\circ\text{C}$		451		ns
Q_r	Recovered Charge			7.62		μC
I_{RM}	Peak Reverse Recovery Current			30.6		A
E_{rec}	Reverse Recovery Energy			2.63		mJ
t_{rr}	Diode Reverse Recovery Time	$V_R=600\text{V}, I_F=75\text{A},$ $-di/dt=400\text{A}/\mu\text{s}, V_{GE}=-15\text{V},$ $L_S=40\text{nH},$ $T_j=175^\circ\text{C}$		481		ns
Q_r	Recovered Charge			8.98		μC
I_{RM}	Peak Reverse Recovery Current			33.1		A
E_{rec}	Reverse Recovery Energy			3.13		mJ

Discrete Characteristics $T_C=25^\circ\text{C}$ unless otherwise noted

Symbol	Parameter	Min.	Typ.	Max.	Unit
R_{thJC}	Junction-to-Case (per IGBT)			0.176	K/W
	Junction-to-Case (per Diode)			0.280	
R_{thJA}	Junction-to-Ambient		40		K/W

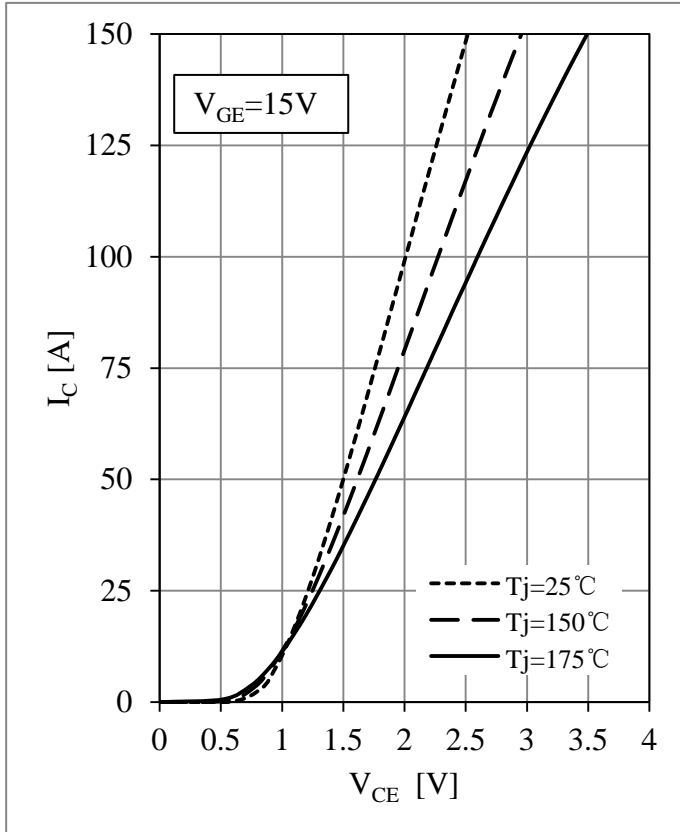

Fig 1. IGBT-inverter Output Characteristics

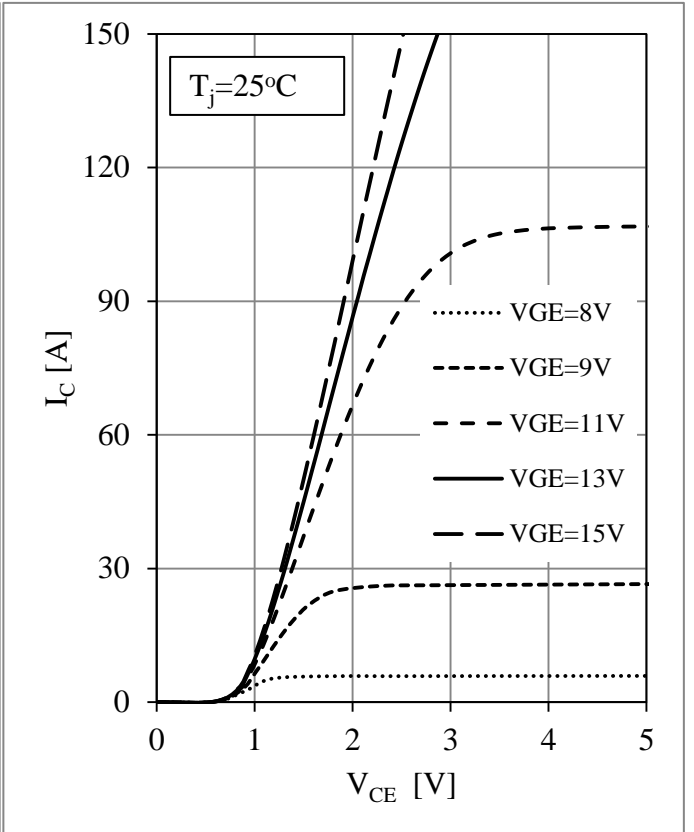

Fig 2. IGBT Output Characteristics

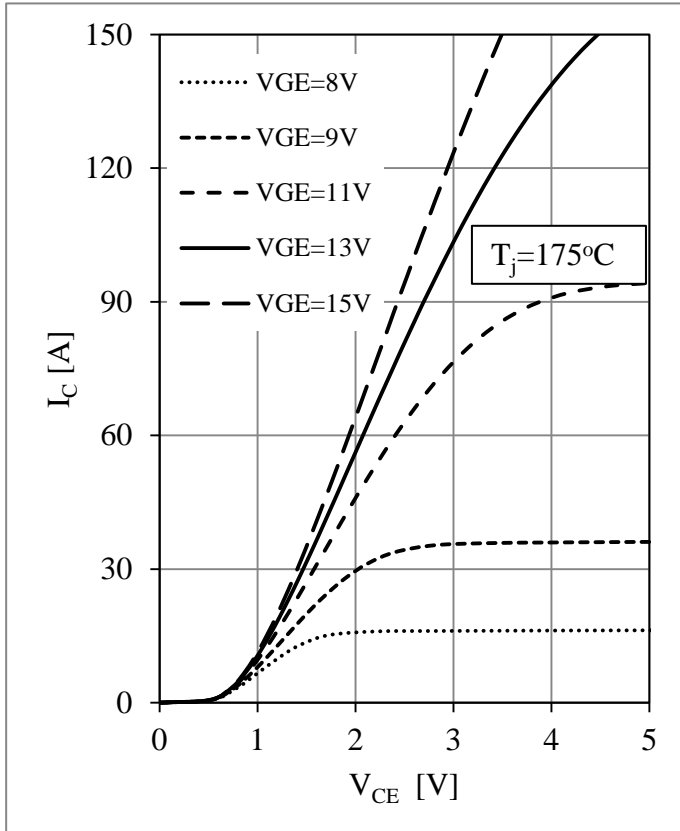

Fig 3. IGBT Output Characteristics

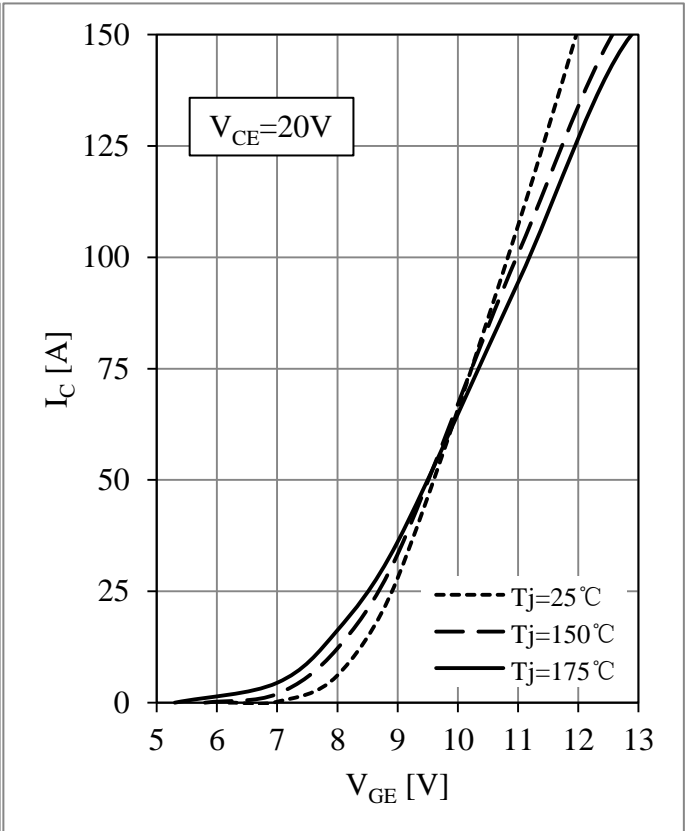

Fig 4. IGBT-inverter Transfer Characteristics

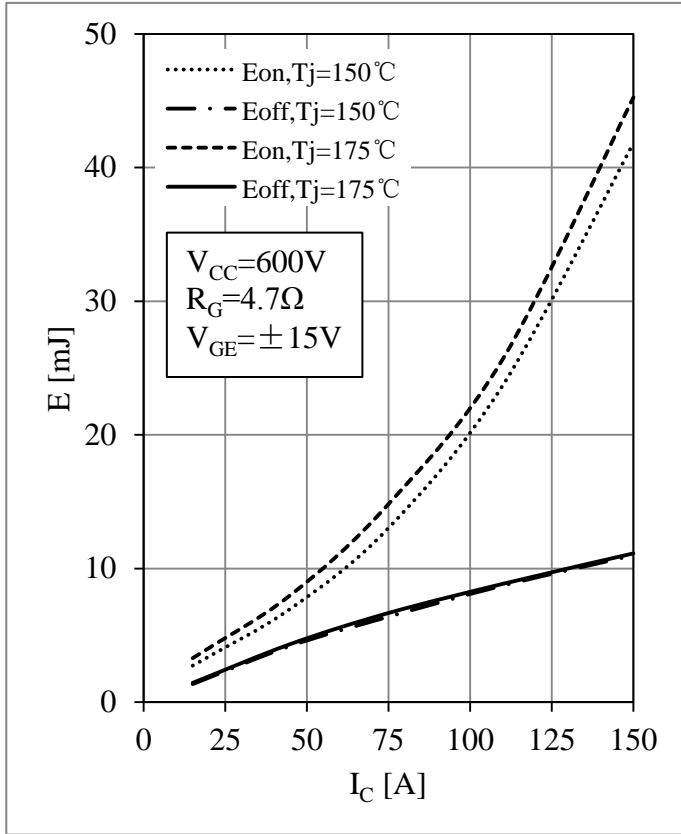

Fig 5. IGBT-inverter Switching Loss vs. I_C

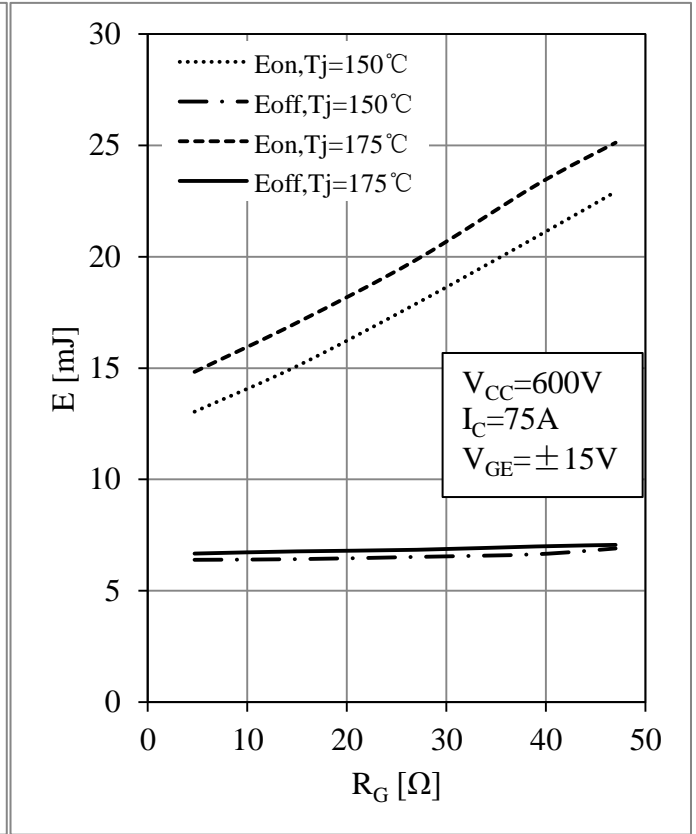

Fig 6. IGBT-inverter Switching Loss vs. R_G

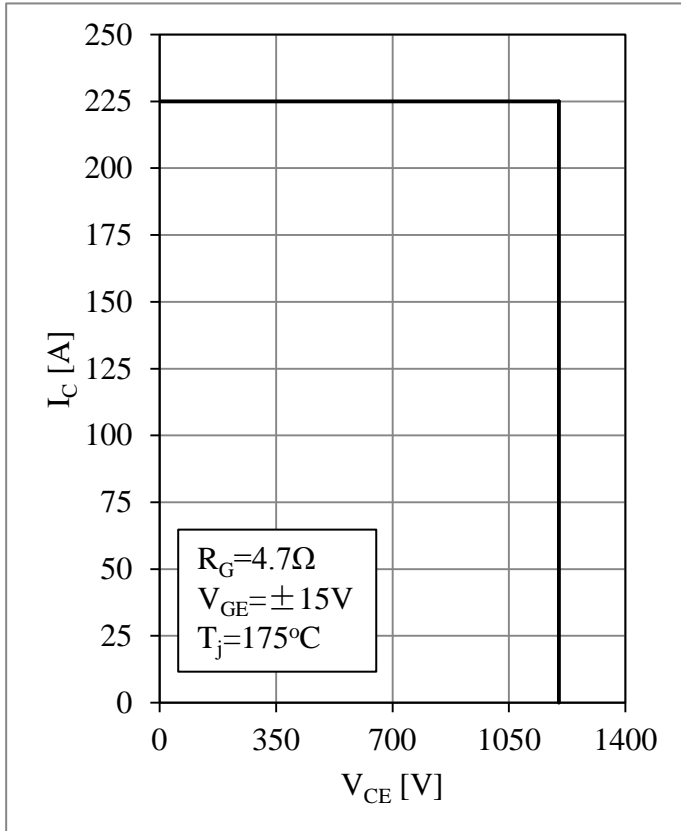

Fig 7. IGBT-inverter RBSOA

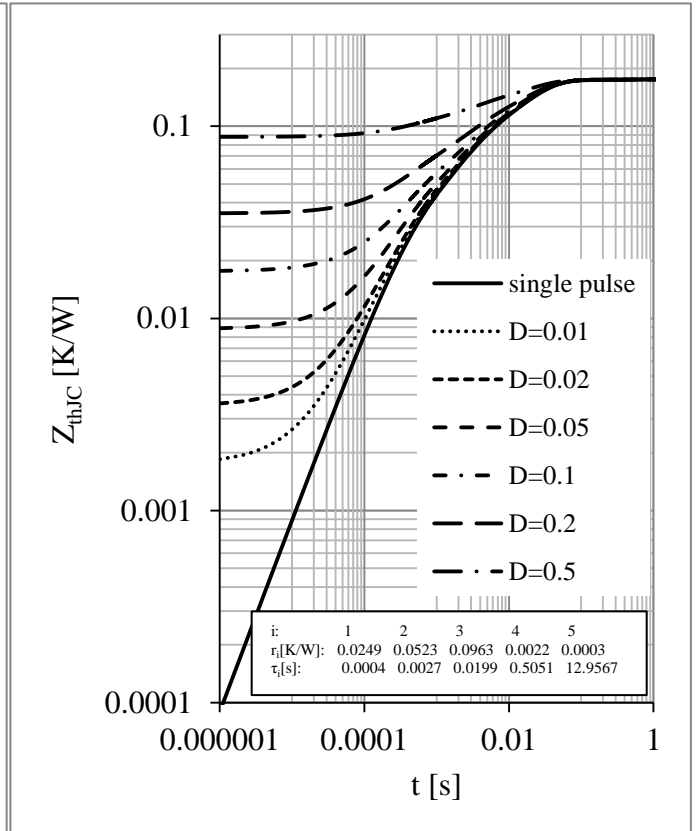

Fig 8. IGBT-inverter Transient Thermal Impedance

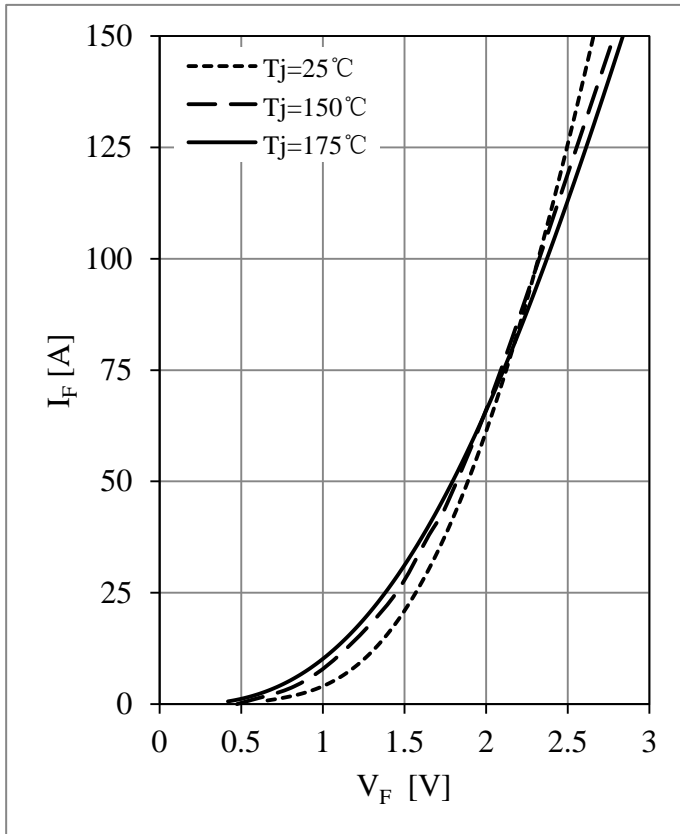

Fig 9. Diode-inverter Forward Characteristics

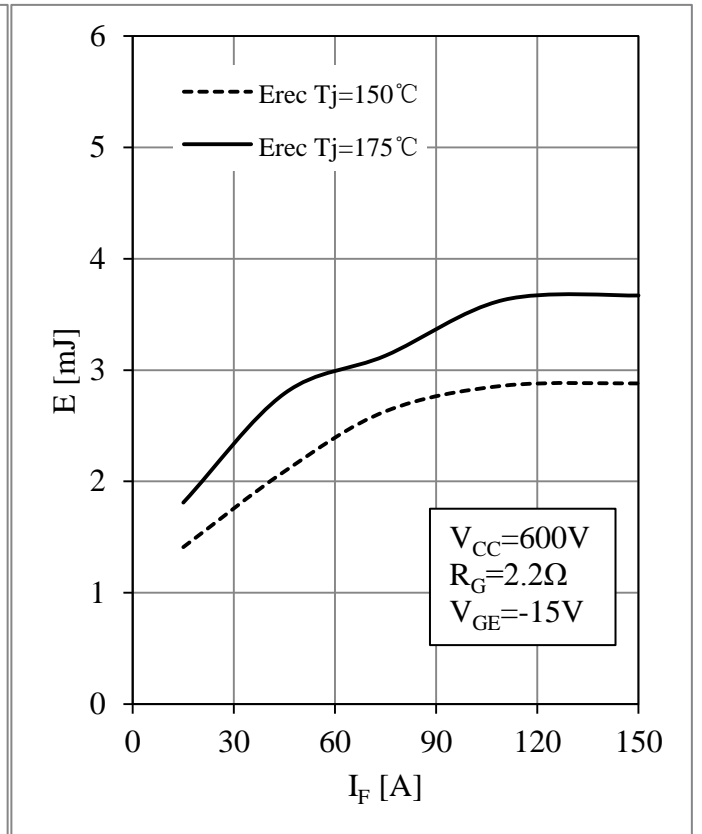

Fig 10. Diode-inverter Switching Loss vs. I_F

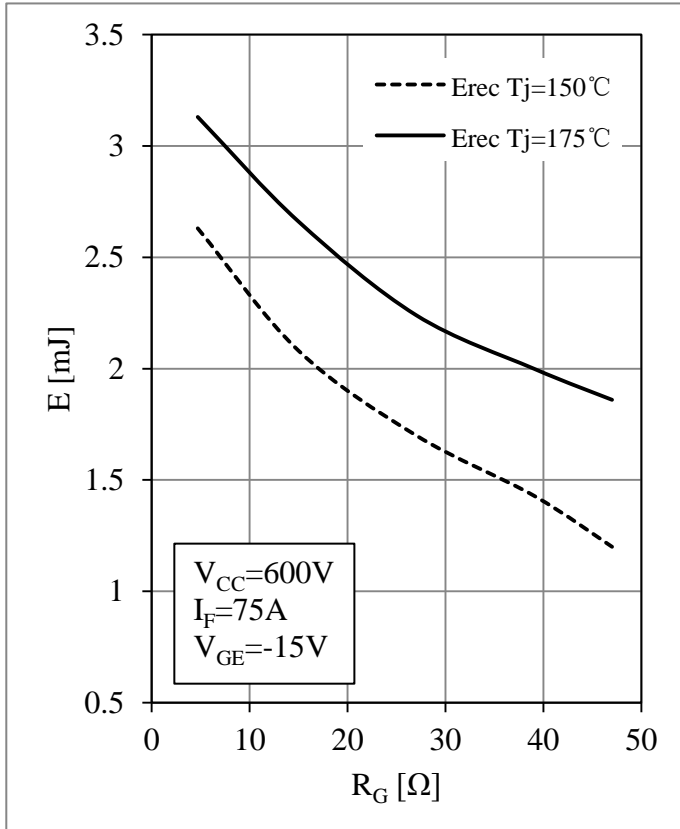

Fig 11. Diode-inverter Switching Loss vs. R_G

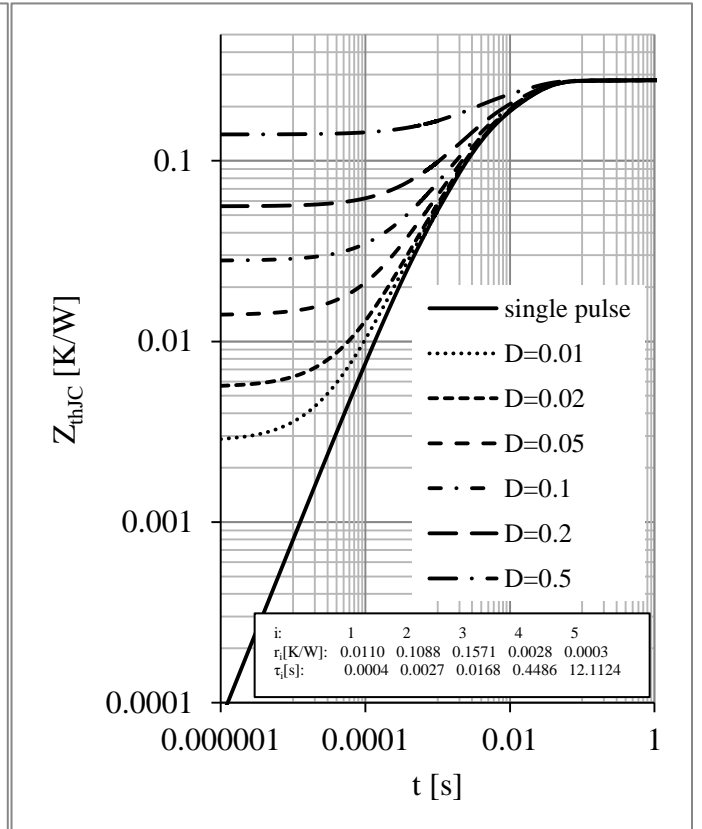
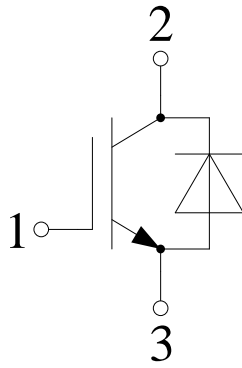

Fig 12. Diode-inverter Transient Thermal Impedance

Circuit Schematic



Package Dimensions

Dimensions in Millimeters

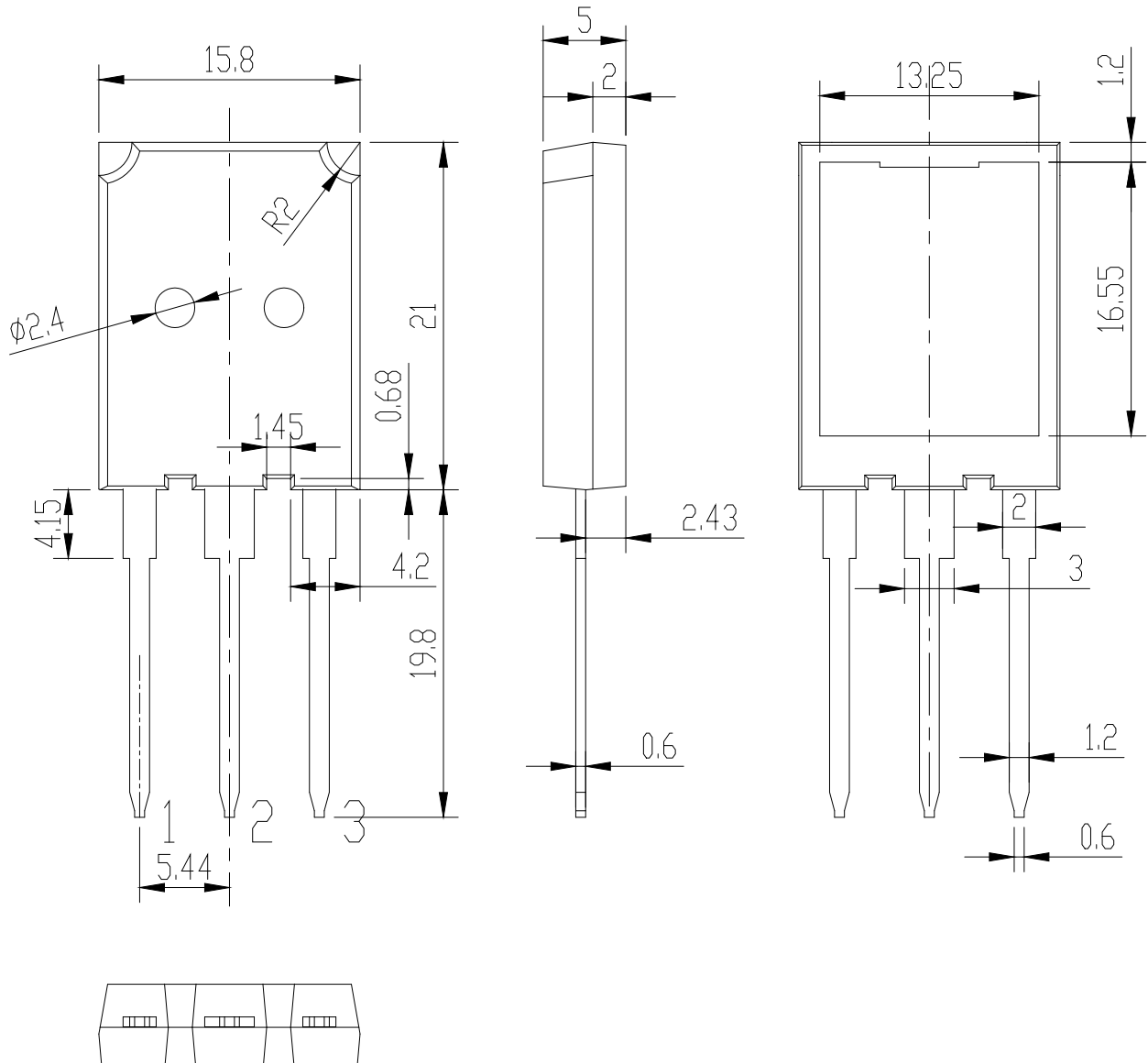

Terms and Conditions of Usage

The data contained in this product datasheet is exclusively intended for technically trained staff. you and your technical departments will have to evaluate the suitability of the product for the intended application and the completeness of the product data with respect to such application.

This product data sheet is describing the characteristics of this product for which a warranty is granted. Any such warranty is granted exclusively pursuant the terms and conditions of the supply agreement. There will be no guarantee of any kind for the product and its characteristics.

Should you require product information in excess of the data given in this product data sheet or which concerns the specific application of our product, please contact the sales office, which is responsible for you (see www.powersemi.cc), For those that are specifically interested we may provide application notes.

Due to technical requirements our product may contain dangerous substances. For information on the types in question please contact the sales office, which is responsible for you.

Should you intend to use the Product in aviation applications, in health or live endangering or life support applications, please notify.

If and to the extent necessary, please forward equivalent notices to your customers.
Changes of this product data sheet are reserved.

X-ON Electronics

Largest Supplier of Electrical and Electronic Components

Click to view similar products for [IGBT Transistors](#) category:

Click to view products by [STARPOWER](#) manufacturer:

Other Similar products are found below :

[IRG4PC30W](#) [APT20GT60BRDQ1G](#) [STGWA25H120DF2](#) [APT30GS60BRDQ2G](#) [TIG058E8-TL-H](#) [IDW40E65D2](#) [IXGF30N400](#)
[STGB40V60F](#) [STGWA25H120F2](#) [NGTB75N65FL2WAG](#) [2MBI150VA-060-50](#) [NTE3320](#) [FGD3040G2-F085](#) [FGD3440G2-F085](#)
[STGW80H65DFB-4](#) [AFGY160T65SPD-B4](#) [IGW30N60TP](#) [IGW40N60TP](#) [IGW50N60TP](#) [IHW30N65R5](#) [IKFW40N60DH3E](#) [IKP15N65H5](#)
[IKQ100N60T](#) [IKQ120N60T](#) [IKW30N65WR5](#) [IKW75N60H3](#) [IKZ50N65NH5](#) [IKZ75N65NH5](#) [FGD3040G2-F085C](#) [FGH4L50T65SQD](#)
[FGHL40T65MQDT](#) [FGHL50T65MQD](#) [FGHL50T65MQDTL4](#) [FGHL75T65LQDT](#) [FGHL75T65MQD](#) [FGHL75T65MQDT](#)
[FGHL75T65MQDTL4](#) [FGY75T120SWD](#) [EL3120S1\(TA\)\(SAS\)-V](#) [IHW15N120E1](#) [IKQ75N120CS6](#) [IKA08N65ET6](#) [IKW50N65WR5](#)
[MG150HF12MIC2](#) [SL15T65FK](#) [KGF50N65KDF-U/H](#) [IHF40N65R5S](#) [IKQ75N120CH3](#) [IHW30N160R5](#) [SGM100HF12A1TFD](#)