

# Photovoltaic main catalog

Solarline | Connectors for renewable energy

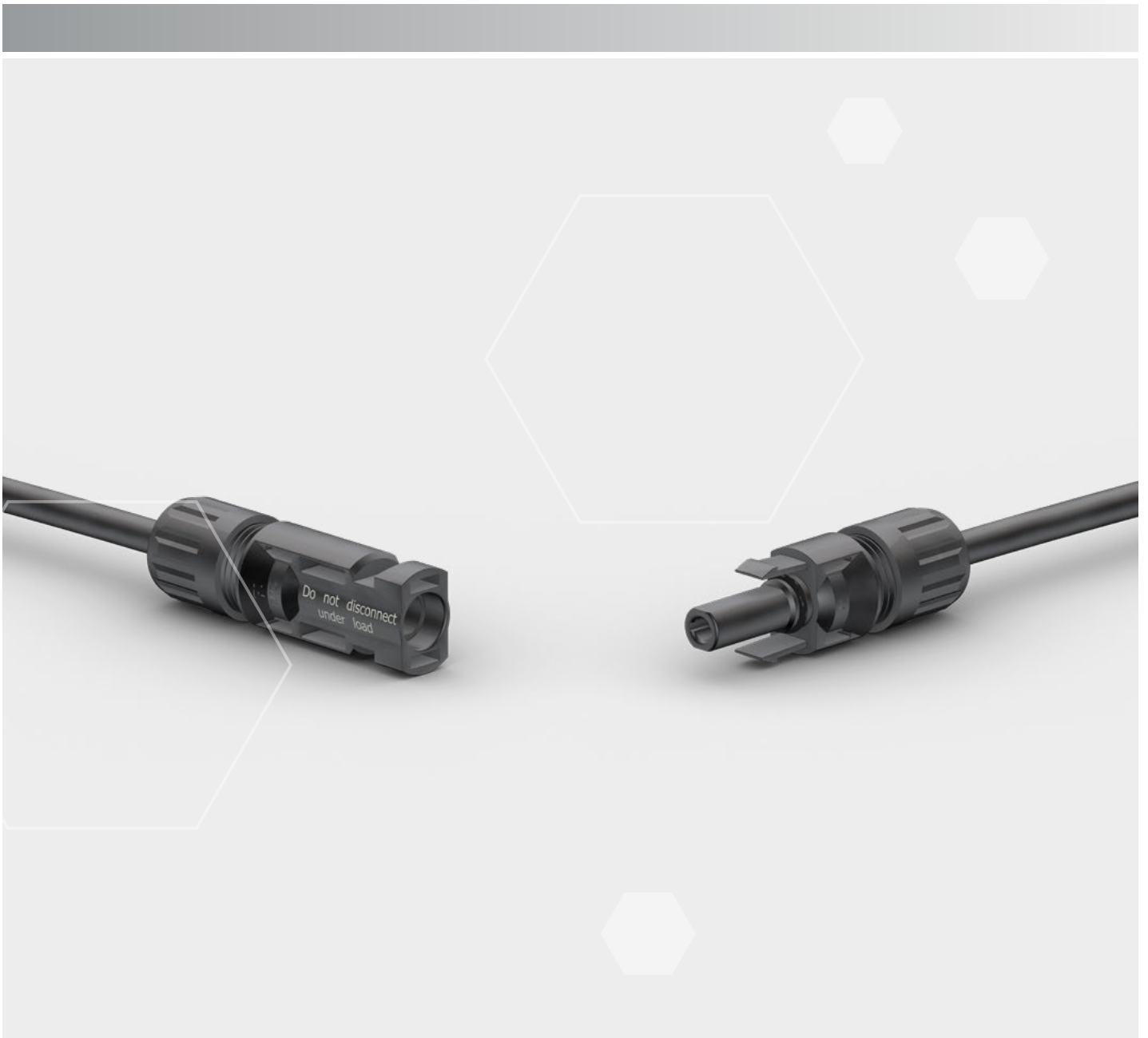

## STÄUBLI ELECTRICAL CONNECTORS

## Long-term solutions – Expert connections



**Stäubli Electrical Connectors is a leading international manufacturer of high-quality electrical connector systems. We are part of the Stäubli Group which offers mechatronics solutions for electrical connectors, liquid and gas couplings, robots and textile machinery.**

Stäubli develops, produces, sells and maintains products for markets with high productivity standards. As recognized specialists, our focus is always on solutions and customers. Many new developments got their start here and have begun to make their way around the world.

Businesses and customers count on our commitment and our active support when dealing with unusual problems. With us, you are entering into a long-term partnership built on reliability, dynamism, and exceptional quality in both products and services.

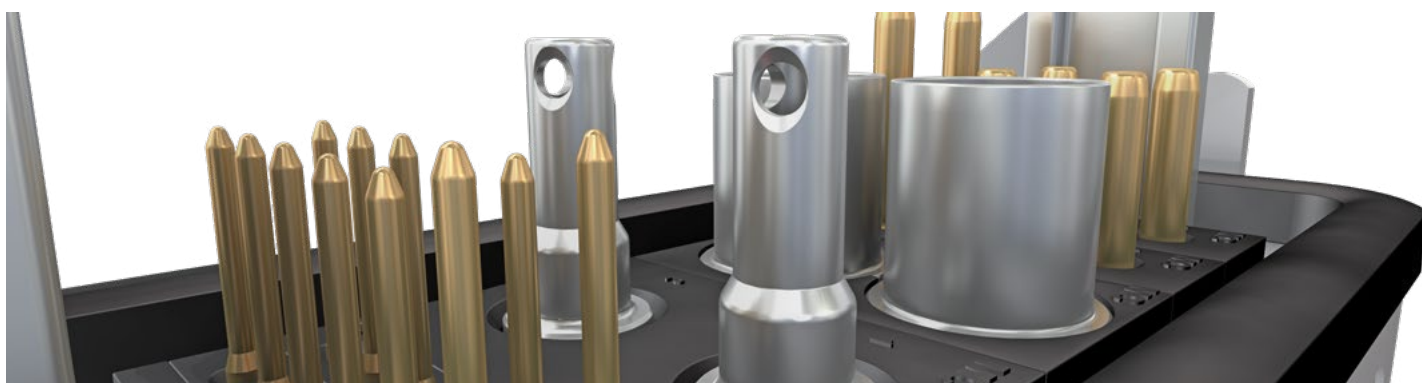

# Applications and benefits



**Offering a wide range of connection systems and accessories for photovoltaics, plug connectors, junction boxes and cables, we have been connecting any type of PV installation to the sun for more than 20 years. As a pioneer and global market leader for PV connectors, Stäubli has been setting the industry standard since the introduction of the original MC4 connector. In 2017, over 1 billion original MC4 connectors were installed to connect more than 150 GW which comes up to almost 50% of the PV power worldwide.**

Thanks to the tried and tested MULTILAM advanced contact technology, our connectors keep your PV installation up and running efficiently and safely.

These apparently minor components can have a massive impact. Outstanding reliability and consistently low contact resistance guarantee:

- Low service cost and reduced downtime
- Elimination of risks for hotspots and fire
- Low power losses

Stäubli PV connectors guarantee proper operation over their whole lifetime (>25 years). By minimizing risk and maximizing the return in the long term, our components influence LCOE positively and have a decisive impact on the bankability of photovoltaic projects.



[www.staubli-alternative-energies.com](http://www.staubli-alternative-energies.com)

# Content

- Page 7**      **Introduction**
- Range of applications
  - Advantages of Stäubli PV products
- Page 8**      **Plug connectors**
- Overview
  - Product specifications
- Page 32**     **Junction boxes**
- Overview
  - Product specifications
- Page 44**     **Cables**
- Flex-Sol-Evo
  - In-line-Fuse
  - Branch cable
- Page 50**     **Accessories**
- Page 54**     **Tools**
- Page 60**     **Forms**
- Forms for customer-specific products
- Page 64**     **Appendix**
- Technical information
  - Alphabetical index

# Safety note

Plug connectors not manufactured by Stäubli are sometimes described by their manufacturers as being “Stäubli compatible” due to their ability to mate with Stäubli connectors. This, however, is not true: by doing so, they do not conform to the requirements for a safe electrical connection with long-term stability. For that reason, we accept no liability if these non-approved connectors are mated with Stäubli original connectors.

**Stäubli has not recognized any products from third-party suppliers as being plug-compatible with the MC4 family and does not intend to do so in the future.** Using unsuitable components or combining plugs from different manufacturers poses significant risks (high failure rates, fire, etc.) and is not permitted under any circumstances.

Please note that all certifications are voided when such a plug combination is used.

Statements made by TÜV and UL confirm this: TÜV Rheinland LGA Products GmbH, based in Cologne, stresses that compatibility can be confirmed “only for products of the same type family from the same manufacturer” and that the current certificate for the MC4 connector family is based “on positive results of tests on products with corresponding mating parts of the MC4 family.” As there is uncertainty in the case of warranty claims involving combined PV connector pairs from different manufacturers, “the PV installation inspectors are obliged to criticize the use of such combinations.” It is also stated in UL file QIJQ2.E343181 that only “connectors within a product family are

approved by UL.” UL clearly distances itself from declaring compatibility of components from different manufacturers due to uncertainty over long-term behavior.



# General information

## Colour code

For those items available in various colours, replace the asterisk “\*” with the appropriate colour code.

21	black	22	red
23	blue	29	white

## Changes / Provisos

All data, illustrations and drawings in the catalogue have been carefully checked. They are in accordance with our experience to date, but no responsibility can be accepted for errors.

We also reserve the right to make modifications for design and safety reasons. When designing equipment incorporating our components, it is therefore advisable not to rely solely on the data in the catalogue but to consult us to make sure this information is up to date. We shall be pleased to advise you.

## Copyright

The use of this catalogue for any other purpose, in whatever form, without our prior written consent is not permitted.

## RoHS ready

Directive 2011/65/EC on the restriction of the use of certain hazardous substances in electrical and electronic equipment.

## Symbols



**Accessories or special tools exist for this product**



**The assembly instruction MA000 is available for this product**



**Check out the interactive content for this product**

UNLIMITED POSSIBILITIES FOR CONTACT SOLUTIONS

MULTILAM Technology



**MULTILAM** are specially formed and resilient contact elements. All Stäubli Electrical Connectors products benefit from the unique and outstanding performance of the **MULTILAM** Technology.

Thanks to their constant spring pressure, MULTILAM louvers ensure continuous contact with the contact surface, resulting in a constantly low contact resistance.

MULTILAM Technology allows to find solutions for connectors within the severest constraints and in certain products for up to 1 million mating cycles.

This makes the MULTILAM Technology the best choice for applications with demanding requirements:

- Reliable and longlife operation due to constantly high performance
- Safe operation under highest environmental demands on temperature, vibration and shock
- Suitable for data and signal contacts as well as high-current connectors
- Automated solutions with a high number of mating cycles

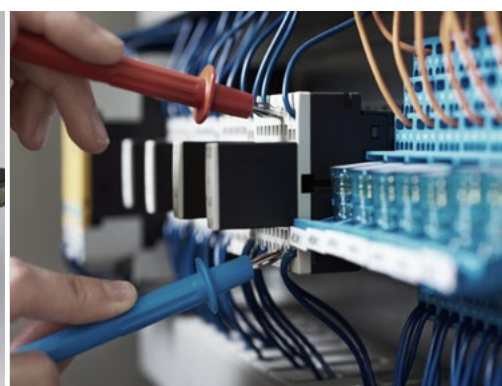

## INTRODUCTION

# Application possibilities of the Stäubli product portfolio

### Examples of a PV field installation

The upper example shows the MC4 plug connector system (1) and a customized, two-pole junction box (2).

The illustration in the middle shows the MC4 plug connector system (3) and the single-pole PV-JB/TB (4).

At the bottom an example of a PV roof installation with MC4 plug connector system (5), PV-JB/WL-... junction box (6) branch cable (7), branch socket/plug (8) and MC4 panel receptacles (9).

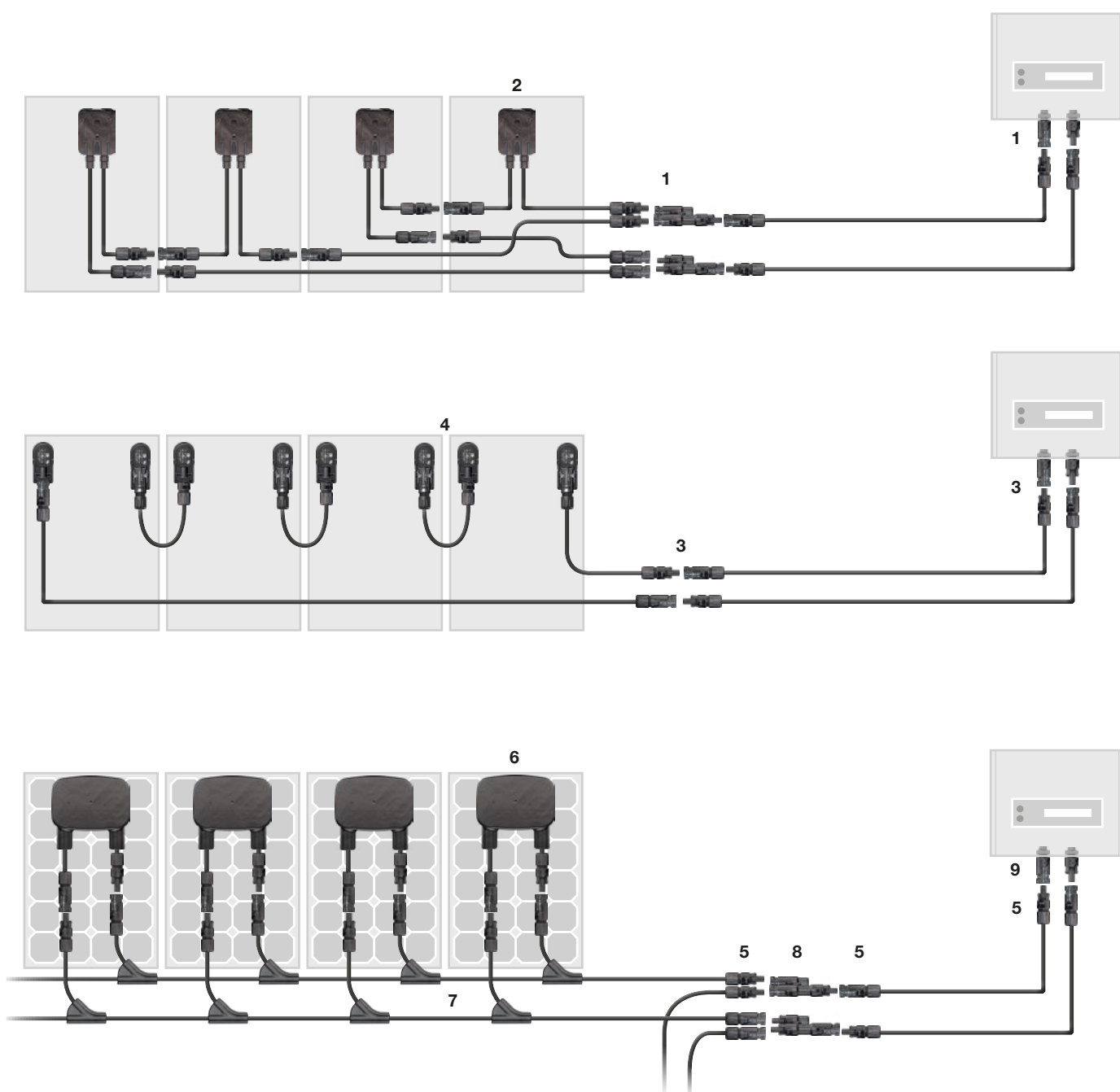

**PLUG CONNECTORS**

# Advantages of the MC4 connector range

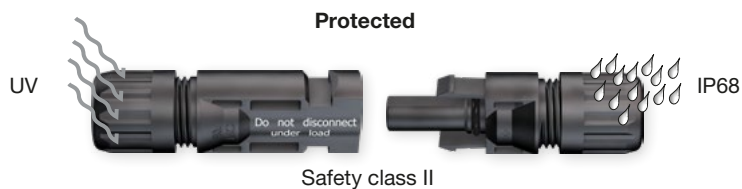

**Proven MULTILAM technology with high long-term stability**



More than 50 years of experience and core competence

**Range of cable cross-sections**

- |                     |   |   |        |
|---------------------|---|---|--------|
| 10 mm <sup>2</sup>  | ○ | ○ | 8 AWG  |
| 6 mm <sup>2</sup>   | ○ | ○ | 10 AWG |
| 4 mm <sup>2</sup>   | ○ | ○ | 12 AWG |
| 2.5 mm <sup>2</sup> | ○ | ○ | 14 AWG |
| 1.5 mm <sup>2</sup> | ○ |   |        |

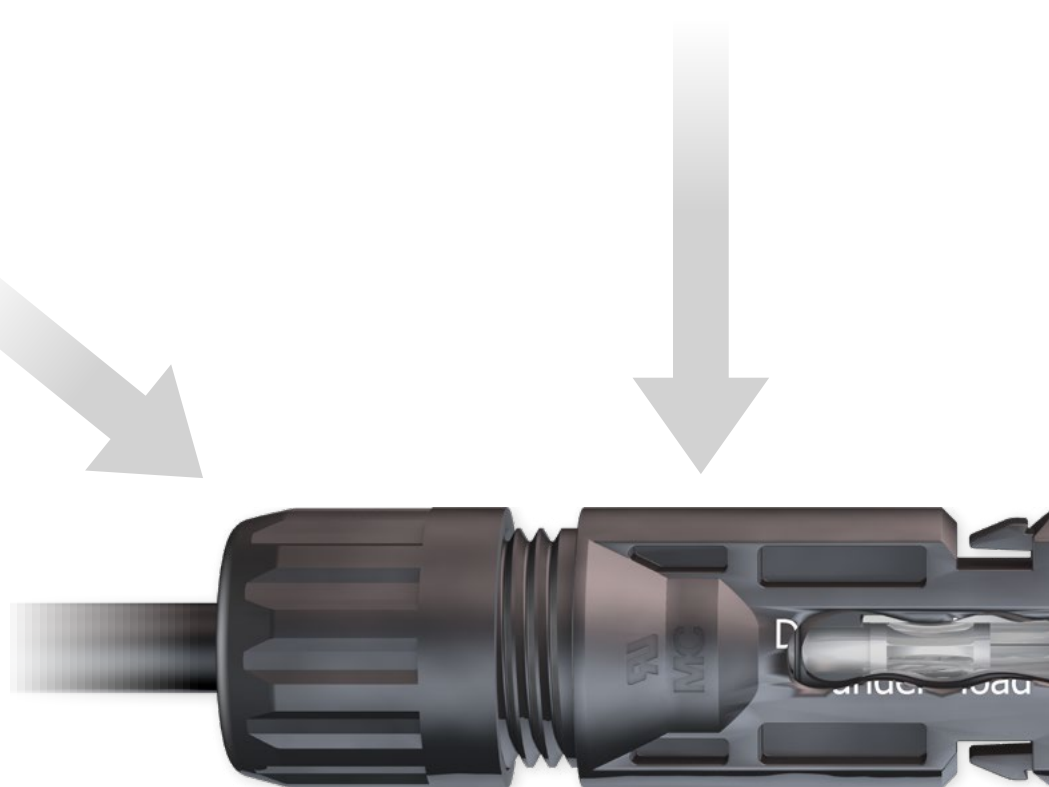

**Locking system**





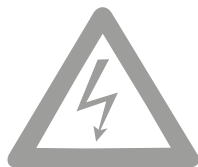

**Voltage level**

TÜV 1000 V/1500 V  
UL 1000 V/1500 V

**Compatibility**

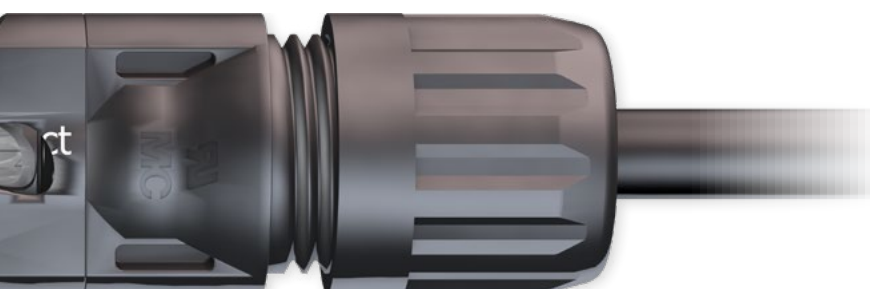
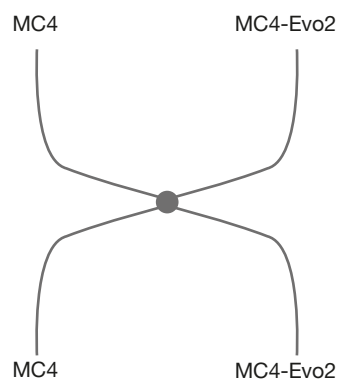

**Certificates**

**TÜV**

These products are certified by TÜV Rheinland LGA GmbH



cTÜVus



UL recognized



GOST-R



CSA



JET























CQC

**Safety locking device**

NEC 2014



# Overview of plug connectors

		Approvals <sup>1)</sup>
<b>Plug connectors</b>		
MC4		TÜV    
MC4-Evo2		TÜV   
MC4-EvoAC		TÜV 
<b>Panel receptacles</b>		
MC4		TÜV   
MC4-Evo2		TÜV 
<b>Branch connectors</b>		
MC4		 

## Legend





















Assembly with tool



Available as ready-assembled product



For assembly on site

Features	Salt mist spray test	Rated current	Rated voltage (max.)				Locking system (UL)	Degree of protection		Safety class	Ambient temperature range	Sealing caps	Page
			Category	TÜV (V DC)	UL/CSA (V DC)	TÜV (V AC)		UL (V AC)	mated				
   	VI	17/22.5/30/45/50	1500	1500	-	-	Locking	IP65 IP68	IP2X	II	-40 ... +85 (TÜV)	x	12 14
   	-	22/39/45/53/69	1500	1500	-	-	Locking	IP65 IP68	IP2X	II	-40...+85 (TÜV)	x	16 18
 	-	16/20/26/32/43	-	-	250	600	Locking	IP65 IP67	IP2X	II	-40...+85	x	20
   	-	17/22.5/30	1250	1500	-	-	Locking	IP65 IP68	IP2X	II	-40...+85	x	22 24
   	-	32/42/47	1500	1500	-	-	Locking	IP65 IP68	IP2X	II	-40...+90 (UL)	x	26 28
	-	50	-	1500	-	-	Locking	IP67	IP2X	II	-40...+85 (UL)	x	30



Suitable for customer-specific assembly

<sup>1)</sup> Certifications are in some cases limited to specific types or still pending. Details are given on the relevant product pages.

# Female and male cable coupler MC4

Female and male cable coupler as individual part (including insulating part)

PV-KBT4...

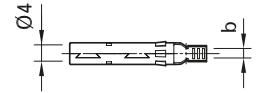
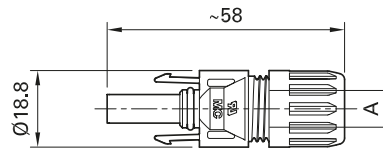

PV-KST4...

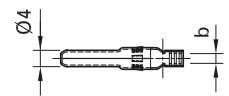
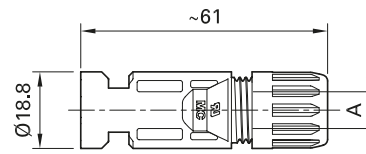

Order No.	Type	Female cable coupler	Male cable coupler	Ø range of cable gland	Conductor cross section			Approvals			
					A (mm)	mm <sup>2</sup>	AWG	b (mm)	TÜV	UL	SA
32.0010P0001-UR	PV-KBT4/2,5I-UR	x		5-6	2.5	14	3				
32.0011P0001-UR	PV-KST4/2,5I-UR		x	5-6	2.5	14	3				
32.0140P0001-UR	PV-KBT4/2,5X-UR	x		5.5-7.4	2.5	14	3				
32.0141P0001-UR	PV-KST4/2,5X-UR		x	5.5-7.4	2.5	14	3				
32.0012P0001-UR	PV-KBT4/2,5II-UR	x		5.9-8.8	2.5	14	3				
32.0013P0001-UR	PV-KST4/2,5II-UR		x	5.9-8.8	2.5	14	3	x	x	x	x
32.0014P0001-UR	PV-KBT4/6I-UR	x		5-6	4; 6	12; 10	5				
32.0015P0001-UR	PV-KST4/6I-UR		x	5-6	4; 6	12; 10	5				
32.0142P0001-UR	PV-KBT4/6X-UR	x		5.5-7.4	4; 6	12; 10	5				
32.0143P0001-UR	PV-KST4/6X-UR		x	5.5-7.4	4; 6	12; 10	5				
32.0016P0001-UR	PV-KBT4/6II-UR	x		5.9-8.8	4; 6	12; 10	5				
32.0017P0001-UR	PV-KST4/6II-UR		x	5.9-8.8	4; 6	12; 10	5				
32.0080-UR	PV-KBT4/8II-UR	x		6.05-8.56	-	8	4.4		x	x	
32.0081-UR	PV-KST4/8II-UR		x	6.05-8.56	-	8	4.4				
32.0034P0001	PV-KBT4/10II	x		5.9-8.8	10	-	7.2	x			x
32.0035P0001	PV-KST4/10II		x	5.9-8.8	10	-	7.2				

**Note:**

For more detailed information concerning the suitable cable gland range, please consult MA231



Assembly Instructions MA231

[www.staubli.com/electrical](http://www.staubli.com/electrical)



Sealing caps page 53

Assembly tools page 58

- Snap-in lock
- In accordance with NEC 2014, requires a tool to open
- Proven MULTILAM technology with high long-term stability, which ensures consistently low performance loss throughout the entire service life of the plug connector
- Tried and tested plug connectors, over 15 years of experience in the field
- Available for assembly with cross-sections of 10 mm<sup>2</sup>
- Also available as ready made leads
- Leads made to customer's specifications, see page 60

Technical data	
Connector system	Ø 4 mm
Rated voltage	1000 V DC (IEC 62852) 1500 V DC (2Pfg2330) <sup>1)</sup> 600 V DC / 1000 V DC / 1500 V DC (UL) <sup>2)</sup>
Rated current TÜV (85°C)	22.5 A (2.5 mm <sup>2</sup> )      39 A (4 mm <sup>2</sup> /6 mm <sup>2</sup> ) 45 A (10 mm <sup>2</sup> )
Rated current UL	22.5 A (14 AWG)    30 A (12 AWG/10 AWG) 50 A (8 AWG)
Rated impulse voltage	12 kV (1000 V DC (TÜV)) 16 kV (1500 V DC (TÜV))
Ambient temperature range	-40°C...+85°C (TÜV) -40°C...+75°C (UL)
Upper limiting temperature	105°C (TÜV)
Degree of protection, mated unmated	IP65, IP68 (1 h/1 m) IP2X
Overvoltage category/Pollution degree	CATIII/3
Contact resistance of plug connectors	≤0.25 mΩ
Safety class	1000 V DC: II 1500 V DC: 0
Contact system	MULTILAM
Type of termination	Crimping
Contact material	Copper, tin plated
Insulation material	PC/PA
Locking system (UL)	Locking type
Flame class	UL94-V0
Ammonia resistance (acc. to DLG)	1500 h, 70°C/70% RH, 750 ppm
Salt mist spray test, degree of severity 6	IEC 60068-2-52
TÜV-Rheinland certified, in accordance with IEC 62852	R60111354 <sup>3)</sup>
TÜV-Rheinland certified, in accordance with 2Pfg2330	R60087448
UL recognized component, in accordance with UL 6703	E343181
CSA certified, in accordance with UL 6703	250725
CQC certified according CNCA/CTS0002-2012	CQC16024138286

<sup>1)</sup> 2Pfg2330: only approved for locations with restricted access

<sup>2)</sup> for selected configurations; see assembly instructions MA231 for details

<sup>3)</sup> For PV junction boxes in accordance with IEC62790, lines in accordance with EN50618 must be used

# Female and male cable coupler MC4

Contacts on carrier band (including insulating part)

PV-KBT4...  
PV-KST4...

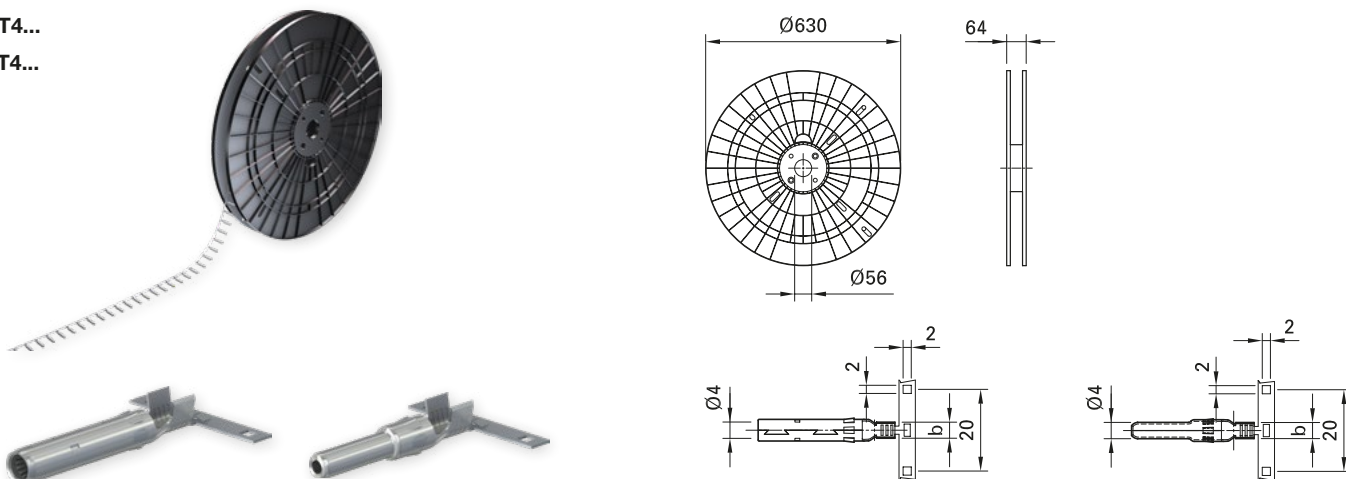

Order No.	Type	Female cable coupler	Male cable coupler	Ø range of cable gland	Conductor cross section			Crimping tool	Contacts per reel <sup>2)</sup>	Approvals							
					A (mm)	mm <sup>2</sup>	AWG			b (mm)	TÜV	RA	SA	cec			
32.0010P2000-UR	PV-KBT4/2,5I-UR	x		5-6	2.5	14	3	<sup>1)</sup>	2000	x	x	x	x				
32.0011P2000-UR	PV-KST4/2,5I-UR		x	5-6	2.5	14	3	<sup>1)</sup>	2000								
32.0140P2000-UR	PV-KBT4/2,5X-UR	x		5.5-7.4	2.5	14	3	<sup>1)</sup>	2000								
32.0141P2000-UR	PV-KST4/2,5X-UR		x	5.5-7.4	2.5	14	3	<sup>1)</sup>	2000								
32.0012P2000-UR	PV-KBT4/2,5II-UR	x		5.9-8.8	2.5	14	3	<sup>1)</sup>	2000								
32.0013P2000-UR	PV-KST4/2,5II-UR		x	5.9-8.8	2.5	14	3	<sup>1)</sup>	2000								
32.0014P2000-UR	PV-KBT4/6I-UR	x		5-6	4; 6	12; 10	5	<sup>1)</sup>	2000								
32.0015P2000-UR	PV-KST4/6I-UR		x	5-6	4; 6	12; 10	5	<sup>1)</sup>	2000								
32.0142P2000-UR	PV-KBT4/6X-UR	x		5.5-7.4	4; 6	12; 10	5	<sup>1)</sup>	2000								
32.0143P2000-UR	PV-KST4/6X-UR		x	5.5-7.4	4; 6	12; 10	5	<sup>1)</sup>	2000								
32.0016P2000-UR	PV-KBT4/6II-UR	x		5.9-8.8	4; 6	12; 10	5	<sup>1)</sup>	2000								
32.0017P2000-UR	PV-KST4/6II-UR		x	5.9-8.8	4; 6	12; 10	5	<sup>1)</sup>	2000								
32.0034P1700	PV-KBT4/10II	x		5.9-8.8	10	-	7.2	<sup>1)</sup>	1700					x			x
32.0035P1700	PV-KST4/10II		x	5.9-8.8	10	-	7.2	<sup>1)</sup>	1700								

**Note:**

For more detailed information concerning the suitable cable gland range, please consult MA231



Assembly Instructions MA231

[www.staubli.com/electrical](http://www.staubli.com/electrical)



Sealing caps page 53

Assembly tools page 58

- Feeder bands for fully automatic assembly
- Tools specially designed for MC4 are available for automatic crimping
- Process reliability as result of specially developed supply reel

Technical data	
Connector system	Ø 4 mm
Rated voltage	1000 V DC (IEC 62852) 1500 V DC (2Pfg2330) <sup>3)</sup> 600 V DC / 1000 V DC / 1500 V DC (UL) <sup>4)</sup>
Rated current TÜV (85°C)	22.5 A (2.5 mm <sup>2</sup> )    39 A (4 mm <sup>2</sup> /6 mm <sup>2</sup> ) 45 A (10 mm <sup>2</sup> )
Rated current UL	22.5 A (14 AWG)    30 A (12 AWG/10 AWG) 50 A (8 AWG)
Rated impulse voltage	12 kV (1000 V DC (TÜV)) 16 kV (1500 V DC (TÜV))
Ambient temperature range	-40°C...+85°C (TÜV); -40°C...+75°C (UL)
Upper limiting temperature	105°C (TÜV)
Degree of protection, mated unmated	IP65, IP68 (1 h / 1 m) IP2X
Overvoltage category / Pollution degree	CATIII / 3
Contact resistance of plug connectors	≤ 0.25 mΩ
Safety class	1000 V DC: II 1500 V DC: 0
Contact system	MULTILAM
Type of termination	Crimping
Contact material	Copper, tin plated
Insulation material	PC / PA
Locking system (UL)	Locking type
Flame class	UL94-V0
Ammonia resistance (acc. to DLG)	1500 h, 70°C / 70% RH, 750 ppm
Salt mist spray test, degree of severity 6	IEC 60068-2-52
TÜV-Rheinland certified, in accordance with IEC 62852	R60111354 <sup>5)</sup>
TÜV-Rheinland certified, in accordance with 2Pfg2330	R60087448
UL recognized component, in accordance with UL 6703	E343181
CSA certified, in accordance with UL 6703	250725
CQC certified according CNCA/CTS0002-2012	CQC16024138286

<sup>1)</sup> Information about a semi-automatic crimp device or assembly device on request

<sup>2)</sup> Reel type subject to alterations

<sup>3)</sup> 2Pfg2330: Only for use in PV-systems with restricted access locations

<sup>4)</sup> For selected configurations; see assembly instructions MA231 for details

<sup>5)</sup> For PV junction boxes in accordance with IEC62790, lines in accordance with EN50618 must be used

# Female and male cable coupler MC4-Evo2

Female and male cable coupler as individual part (including insulating part)

PV-KBT4-EVO 2/...-UR

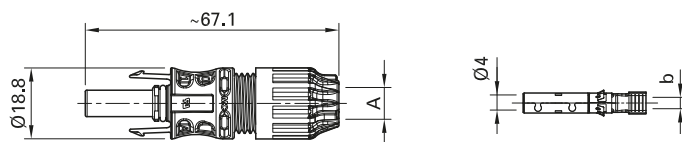

PV-KST4-EVO 2/...-UR

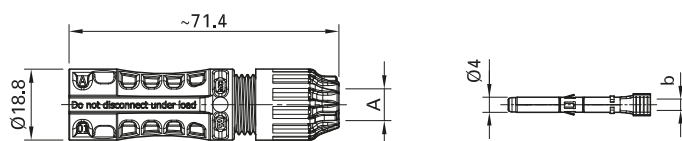

Order No.	Type	Female cable coupler	Male cable coupler	Ø range of cable gland		Conductor cross section		Approvals
				A (mm)	mm <sup>2</sup>	AWG	b (mm)	
32.0082P0001-UR	PV-KBT4-EVO 2/2,5I-UR	x		4.7-6.4	2.5	14	3	  
32.0083P0001-UR	PV-KST4-EVO 2/2,5I-UR		x	4.7-6.4				
32.0084P0001-UR	PV-KBT4-EVO 2/2,5II-UR	x		6.4-8.4	4; 6	12; 10	5	
32.0085P0001-UR	PV-KST4-EVO 2/2,5II-UR		x	6.4-8.4				
32.0086P0001-UR	PV-KBT4-EVO 2/6I-UR	x		4.7-6.4	10	8	7.2	
32.0087P0001-UR	PV-KST4-EVO 2/6I-UR		x	4.7-6.4				
32.0088P0001-UR	PV-KBT4-EVO 2/6II-UR	x		6.4-8.4	10	8	7.2	
32.0089P0001-UR	PV-KST4-EVO 2/6II-UR		x	6.4-8.4				
32.0092P0001-UR	PV-KBT4-EVO 2/10II-UR	x		6.4-8.4	10	8	7.2	
32.0093P0001-UR	PV-KST4-EVO 2/10II-UR		x	6.4-8.4				

**Note:**

For more detailed information concerning the suitable cable gland range, please consult MA273.



Sealing caps page 53

Assembly tools page 58



Assembly Instructions MA273

[www.staubli.com/electrical](http://www.staubli.com/electrical)



- Internationally certified with IEC, UL, JET, cTÜVus.
- Approved for 1500 V DC (IEC, JET), 1500 V DC (UL) unrestricted access
- MULTILAM Technology, has proven the quality and durability several 100 million times since 2004
- Suited for all climatic environments thanks to resistance to UV, ammonia, and high IP class (IP68).
- Available as a field and preassembled connector, standard crimping tools can be used.

Technical data	
Connector system	Ø 4 mm
Rated voltage	1000 V DC / 1500 V DC (TÜV) <sup>1)</sup> 600 V DC / 1000 V DC / 1500 V DC (UL) <sup>2)</sup> 1500 V DC (JET) <sup>3)</sup>
Rated current TÜV (85°C)	39 A (2.5 mm <sup>2</sup> / 14 AWG) 45 A (4.0 mm <sup>2</sup> / 12 AWG) 53 A (6.0 mm <sup>2</sup> / 10 AWG) 69 A (10.0 mm <sup>2</sup> / 8 AWG)
Rated impulse voltage	12 kV (1000 V) 16 kV (1500 V)
Ambient temperature range	-40°C ... +85°C (TÜV/UL)
Upper limiting temperature	115°C (TÜV)
Degree of protection, mated unmated	IP65/IP68 (1h/1m) IP2X
Overvoltage category/Pollution degree	CAT III/3
Contact resistance of plug connectors	≤ 0.2 mΩ
Safety class	II
Contact system	MULTILAM
Type of termination	Crimping
Contact material	Copper, tin plated
Insulation material	PA
Locking system (UL)	Locking type
Flame class	UL94-V0
Ammonia resistance (acc. to TÜV)	Q60095359
TÜV-Rheinland certified, in accordance with IEC 62852:2014 UL recognized component, in accordance with UL 6703 cTÜVus certified according UL 6703 JET certified according IEC 61730-1:2004	R60098495 E343181 CU 72141256 01 B13T0062

<sup>1)</sup> Please take the cable to be used from MA273

<sup>2)</sup> The connectors are to be used with USE2 or PV-Wire cables.

<sup>3)</sup> The connectors are to be used with cables with the "S-JET mark" label.

# Female and male cable coupler MC4-Evo2

Contacts on carrier band (including insulating part)

PV-KBT4-EVO 2/...-UR

PV-KST4-EVO 2/...-UR

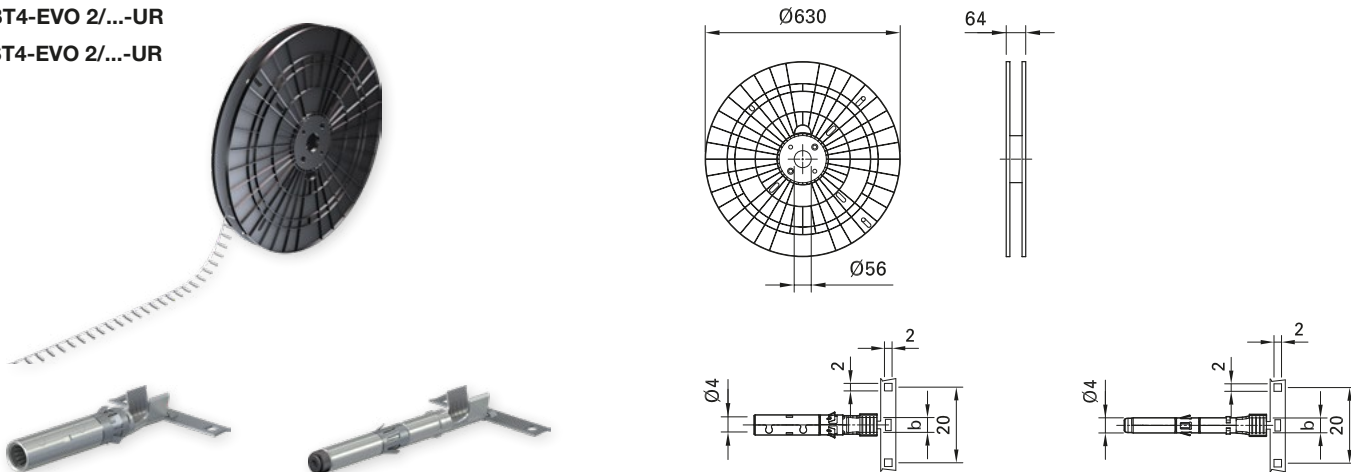

Order No.	Type	Female cable coupler	Male cable coupler	Ø range of cable gland	Conductor cross section			Crimping tool	Contacts per reel <sup>2)</sup>	Approvals
					A (mm)	mm <sup>2</sup>	AWG			
32.0082P2000-UR	PV-KBT4-EVO 2/2,5I-UR	x		4.7-6.4	2.5	14	3	1)	2000	
32.0083P2000-UR	PV-KST4-EVO 2/2,5I-UR		x					1)	2000	
32.0084P2000-UR	PV-KBT4-EVO 2/2,5II-UR	x		1)				2000		
32.0085P2000-UR	PV-KST4-EVO 2/2,5II-UR		x	1)				2000		
32.0086P2000-UR	PV-KBT4-EVO 2/6I-UR	x		4.7-6.4	4; 6	12; 10	5	1)	2000	
32.0087P2000-UR	PV-KST4-EVO 2/6I-UR		x					1)	2000	
32.0088P2000-UR	PV-KBT4-EVO 2/6II-UR	x		6.4-8.4				1)	2000	
32.0089P2000-UR	PV-KST4-EVO 2/6II-UR		x					1)	2000	
32.0092P1700-UR	PV-KBT4-EVO 2/10II-UR	x		6.4-8.4	10	8	7.2	1)	1700	
32.0093P1700-UR	PV-KST4-EVO 2/10II-UR		x					1)	1700	

**Note:**

For more detailed information concerning the suitable cable gland range, please consult MA273.



Sealing caps page 53

Assembly tools page 58



Assembly Instructions MA273

[www.staubli.com/electrical](http://www.staubli.com/electrical)

- Internationally certified with IEC, UL, JET, cTÜVus.
- Approved for 1500 V DC (IEC, JET), 1500 V DC (UL) unrestricted access
- MULTILAM Technology, has proven the quality and durability several 100 million times since 2004
- Suited for all climatic environments thanks to resistance to UV, ammonia, and high IP class (IP68).

Technical data	
Connector system	Ø 4 mm
Rated voltage	1000 V DC / 1500 V DC (TÜV) <sup>3)</sup> 600 V DC / 1000 V DC / 1500 V DC (UL) <sup>4)</sup> 1500 V DC (JET) <sup>5)</sup>
Rated current TÜV (85°C)	39 A (2.5 mm <sup>2</sup> / 14 AWG) 45 A (4.0 mm <sup>2</sup> / 12 AWG) 53 A (6.0 mm <sup>2</sup> / 10 AWG) 69 A (10.0 mm <sup>2</sup> / 8 AWG)
Rated impulse voltage	12 kV (1000 V) 16 kV (1500 V)
Ambient temperature range	-40°C ... +85°C (TÜV/UL)
Upper limiting temperature	115°C (TÜV)
Degree of protection, mated unmated	IP65/IP68 (1h/1m) IP2X
Overvoltage category/Pollution degree	CAT III/3
Contact resistance of plug connectors	≤0.2 mΩ
Safety class	II
Contact system	MULTILAM
Type of termination	Crimping
Contact material	Copper, tin plated
Insulation material	PA
Locking system (UL)	Locking type
Flame class	UL94-V0
Ammonia resistance (acc. to TÜV)	Q60095359
TÜV-Rheinland certified, in accordance with IEC 62852:2014	R60098495
UL recognized component, in accordance with UL 6703	E343181
cTÜVus certified according UL 6703	CU 72141256 01
JET certified according IEC 61730-1:2004	B13T0062

<sup>1)</sup> Information about a semi-automatic crimp device or assembly device on request

<sup>2)</sup> Reel type subject to alterations

<sup>3)</sup> Please take the cable to be used from MA273

<sup>4)</sup> The connectors are to be used with USE2 or PV-Wire cables.

<sup>5)</sup> The connectors are to be used with cables with the "S-JET mark" label

# Female and male cable coupler MC4-EvoAC

Preassembled with cable

MC-K...PV-AC1/B...

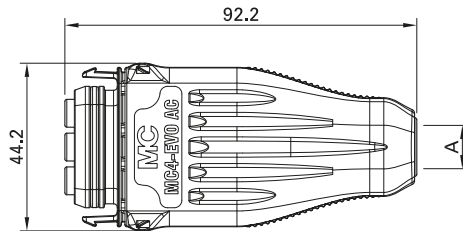

MC-K...PV-AC1/S...

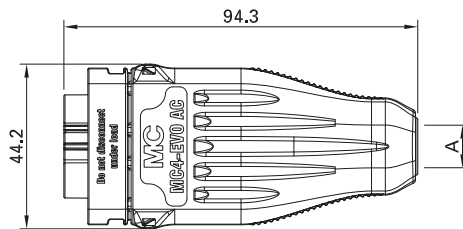

Order No.	Type	Female cable coupler	Male cable coupler	Conductor cross section		Cable	Rated voltage			Approvals	
				mm <sup>2</sup>	AWG		TÜV (V AC)	UL (V AC)	TÜV	UL	
32.1208-10021	MC-K1,5Y3/PV-AC1/BI/100	x		1.5	-	BETAFlam Solar AC flex FRNC	100	250	-	x	
32.1209-10021	MC-K1,5Y3/PV-AC1/SI/100		x	1.5	-						
32.1210-10021	MC-K2,5Y3/PV-AC1/BII/100	x		2.5	-						
32.1211-10021	MC-K2,5Y3/PV-AC1/SII/100		x	2.5	-						
32.1212-10021	MC-K4Y3/PV-AC1/BIII/100	x		4	-						
32.1213-10021	MC-K4Y3/PV-AC1/SIII/100		x	4	-						
32.1214-10021	MC-K1,5Z3/PV-AC1/BII/100	x		-	16	Baohing	-	600		x	
32.1215-10021	MC-K1,5Z3/PV-AC1/SII/100		x	-	16						
32.1216-10021	MC-K2,5Z3/PV-AC1/BII/100	x		-	14						
32.1217-10021	MC-K2,5Z3/PV-AC1/SII/100		x	-	14						
32.1218-10021	MC-K4Z3/PV-AC1/BIII/100	x		-	12						
32.1219-10021	MC-K4Z3/PV-AC1/SIII/100		x	-	12						



Assembly Instructions MA284  
www.staubli.com/electrical



Sealing caps page 53  
Assembly tools page 58

- AC plug connector for micro, nano, and string inverters.
- 250 V (IEC) 600 V (UL)
- MULTILAM technology
- Available preassembled from the factory
- Protection class IP65/IP67
- IP2X unmated protected against contact
- Various codings possible
- Compact form for hidden installation in the module frame or for stackable modules

Technical data	
Connector system	MC4
Rated voltage	250 V AC (TÜV) 600 V AC (UL)
Rated current TÜV (85°C)	1.5 mm <sup>2</sup> : 16 A 2.5 mm <sup>2</sup> : 20 A 4.0 mm <sup>2</sup> : 26 A
Rated current UL (85°C)	16AWG: 26 A 14AWG: 32 A 12AWG: 43 A
Rated impulse voltage	4 kV
Ambient temperature range	-40°C...+85°C
Upper limiting temperature	115°C (TÜV)
Degree of protection, mated unmated	IP65/IP67 IP2X
Overvoltage category/Pollution degree	CATIII/3
Contact resistance of plug connectors	0.25 mΩ
Safety class	II (mated condition)
Contact system	MULTILAM
Type of termination	Crimping
Contact material	Copper, tin plated
Insulation material	PC
Locking system (UL)	Snap-in
Flame class	UL94-V1
TÜV-Rheinland certified, in accordance with 2 Pfg 1915 UL recognized component, in accordance with UL 6703	R60101633  E467440

# Female and male panel receptacle MC4

Female and male panel receptacles as individual part (including insulating part)

PV-ADBP4-S2...

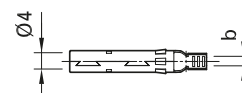
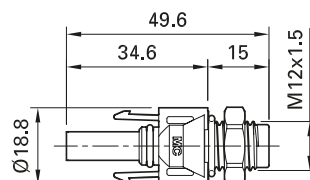

PV-ADSP4-S2...

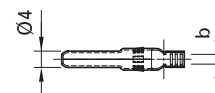
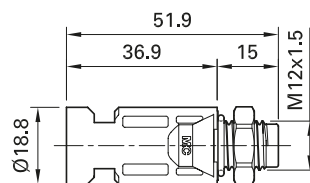

Order No.	Type	Female cable coupler	Male cable coupler	Conductor cross section			Approvals		
				mm <sup>2</sup>	AWG	b (mm)	TÜV	RU	SP
32.0076P0001-UR	PV-ADBP4-S2/2.5-UR	x		1.5; 2.5	14	3	x	x	x
32.0077P0001-UR	PV-ADSP4-S2/2.5-UR		x	1.5; 2.5	14	3			
32.0078P0001-UR	PV-ADBP4-S2/6-UR	x		4; 6	12; 10	5			
32.0079P0001-UR	PV-ADSP4-S2/6-UR		x	4; 6	12; 10	5	x		
32.0150P0001	PV-ADBP4-S2/10	x		10		7.2			
32.0151P0001	PV-ADSP4-S2/10		x	10		7.2			

**Note:**

For more detailed information concerning the suitable cable gland range, please consult MA275.



Sealing caps page 53

Special socket wrench insert page 57

Unlocking tool page 58



Assembly Instructions MA275

[www.staubli.com/electrical](http://www.staubli.com/electrical)

- MC4 panel-receptacle connectors are the interface between an inverter or junction box or junction and a branch cable
- Mounting directly by means of screw thread or in perforated plate with plastic nut (included in delivery)
- Rapid, precise plugging
- Protection class IP68 (1 m/1 h) guarantees the highest connection safety
- Mating compatibility with MC4 connector family
- Includes sealing element for enclosure

Technical data	
Connector system	Ø 4 mm
Rated voltage	1000 V DC / 1250 V DC (TÜV) 1000 V DC / 1500 V DC (UL)
Rated current TÜV (85°C)	17 A (1.5 mm <sup>2</sup> ) 22.5 A (2.5 mm <sup>2</sup> ; 14 AWG) 39 A (4 mm <sup>2</sup> ; 12 AWG) 45 A (6 mm <sup>2</sup> ; 10 AWG) 51 A (10 mm <sup>2</sup> )
Rated impulse voltage	12 kV (1000 V) / 16 kV (1250 V)
Ambient temperature range	-40°C...+85°C (TÜV/UL)
Upper limiting temperature	105°C (TÜV)
Degree of protection, mated unmated	IP65; IP68 (1 m/1 h) IP2X
Overvoltage category / Pollution degree	CAT III / 3
Contact resistance of plug connectors	≤ 0.25 mΩ
Safety class	II
Contact system	MULTILAM
Type of termination	Crimping
Contact material	Copper, tin plated
Insulation material	PC / PA
Locking system (UL)	Locking type
Flame class	UL94-V0
TÜV-Rheinland certified, in accordance with IEC 62852	R60110077
UL recognized component, in accordance with UL 6703	E343181
CSA certified, in accordance with UL 6703	250725

**Note:**

Custom made special versions with cable are also available. Lengths and choice of cable ends on request, see page 60

# Female and male panel receptacle MC4

Contacts on carrier band (including insulating part)

PV-ADBP4-S2...

PV-ADSP4-S2...

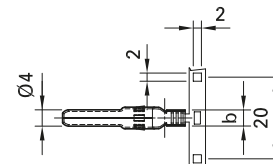
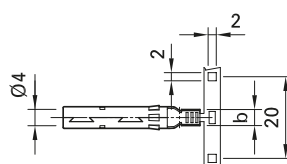
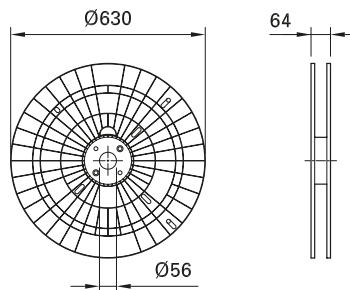

Order No.	Type	Female cable coupler	Male cable coupler	Conductor cross section			Crimping tool	Contacts per Reel <sup>2)</sup>	Approvals		
				mm <sup>2</sup>	AWG	b (mm)			TÜV	UL	CSA
32.0076P2000-UR	PV-ADBP4-S2/2.5-UR	x		1.5; 2.5	14	3	1)	2000	x	x	x
32.0077P2000-UR	PV-ADSP4-S2/2.5-UR		x	1.5; 2.5	14	3	1)	2000			
32.0078P2000-UR	PV-ADBP4-S2/6-UR	x		4; 6	12; 10	5	1)	2000			
32.0079P2000-UR	PV-ADSP4-S2/6-UR		x	4; 6	12; 10	5	1)	2000			
32.0150P1700	PV-ADBP4-S2/10	x		10		7.2	1)	1700	x		
32.0151P1700	PV-ADSP4-S2/10		x	10		7.2	1)	1700			

**Note:**

For more detailed information concerning the suitable cable gland range, please consult MA275.



Sealing caps page 53

Special socket wrench insert page 57

Unlocking tool page 58



Assembly Instructions MA275

[www.staubli.com/electrical](http://www.staubli.com/electrical)



- Feeder bands for fully automatic assembly
- Tools specially designed for MC4 available for automatic crimping
- Process reliability as result of specially developed supply reel

Technical data	
Connector system	Ø 4 mm
Rated voltage	1000 V DC / 1250 V DC (TÜV) 1000 V DC / 1500 V DC (UL)
Rated current TÜV (85°C)	17 A (1.5 mm <sup>2</sup> ) 22.5 A (2.5 mm <sup>2</sup> ; 14 AWG) 39 A (4 mm <sup>2</sup> ; 12 AWG) 45 A (6 mm <sup>2</sup> ; 10 AWG) 51 A (10 mm <sup>2</sup> )
Rated impulse voltage	12 kV (1000 V) / 16 kV (1250 V)
Ambient temperature range	-40°C...+85°C (TÜV/UL)
Upper limiting temperature	105°C (TÜV)
Degree of protection, mated unmated	IP65; IP68 (1 m/1 h) IP2X
Overvoltage category / Pollution degree	CATIII / 3
Contact resistance of plug connectors	≤ 0.25 mΩ
Safety class	II
Contact system	MULTILAM
Type of termination	Crimping
Contact material	Copper, tin plated
Insulation material	PC / PA
Locking system (UL)	Locking type
Flame class	UL94-V0
TÜV-Rheinland certified, in accordance with IEC 62852	R60110077
UL recognized component, in accordance with UL 6703	E343181
CSA certified, in accordance with UL 6703	250725

<sup>1)</sup> Information about a semi-automatic crimp device or assembly device on request

<sup>2)</sup> Reel type subject to alterations

# Female and male panel receptacle MC4-Evo2

Female and male panel receptacles as individual part (including insulating part)

PV-ADB4-EVO 2

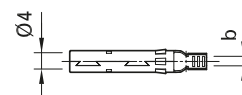
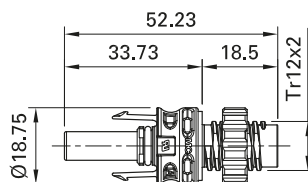

PV-ADS4-EVO 2

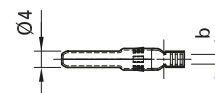
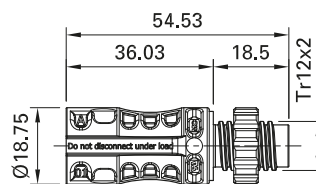

Order No.	Type	Female cable coupler	Male cable coupler	Conductor cross section			Approvals	
				mm <sup>2</sup>	AWG	b (mm)	TÜV	RA
32.0020P0001-UR	PV-ADB4-EVO 2/2,5-UR	x		2.5	14	3	x	x
32.0021P0001-UR	PV-ADS4-EVO 2/2,5-UR		x	2.5	14	3		
32.0022P0001-UR	PV-ADB4-EVO 2/6-UR	x		4.0; 6.0	12; 10	5		
32.0023P0001-UR	PV-ADS4-EVO 2/6-UR		x	4.0; 6.0	12; 10	5		

**Note:**

For more detailed information concerning the suitable cable gland range, please consult MA285.



Sealing caps page 53

Unlocking tool page 58



Assembly Instructions MA285

[www.staubli.com/electrical](http://www.staubli.com/electrical)

- MC4-Evo2 panel-receptacle connectors are the interface between the inverter or the distributor housing and string
- Assembly directly via the threads or in the perforated plate with the plastic nut (contained in scope of delivery)
- Thanks to the D shape, the threaded connection is secured against turning
- For 1500 V DC (IEC), 1500 V DC (UL) approved unobstructed
- Degree of protection IP68 (1m/1h) guarantees highest connection safety
- Fast and clean connection
- Plug compatible with the original MC4 plug connector family
- With preassembled flat seal

Technical data	
Connector system	Ø 4 mm
Rated voltage	1500 V DC (TÜV) 1500 V DC (UL)
Rated current TÜV	32 A (2.5 mm <sup>2</sup> / 14 AWG) 42 A (4.0 mm <sup>2</sup> / 12 AWG) 47 A (6.0 mm <sup>2</sup> / 10 AWG)
Rated impulse voltage	8 kV (1500 V)
Ambient temperature range	-40°C...+85°C (TÜV) -40°C...+90°C (UL)
Upper limiting temperature	115°C
Degree of protection, mated unmated	IP65; IP68 (1m/1h) IP2X
Overvoltage category/Pollution degree	CATIII/3
Contact resistance of plug connectors	≤ 0.2 mΩ
Safety class	II
Contact system	MULTILAM
Type of termination	Crimping
Contact material	Copper, tin plated
Insulation material	PA
Locking system (UL)	Locking type
Flame class	UL94-V0
TÜV-Rheinland certified, in accordance with IEC 62852	R60118815
UL recognized component, in accordance with UL 6703	E343181

# Female and male panel receptacle MC4-Evo2

Contacts on carrier band (including insulating part)

PV-ADB4-EVO 2

PV-ADS4-EVO 2

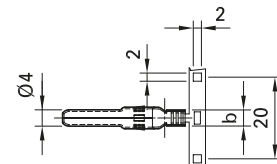
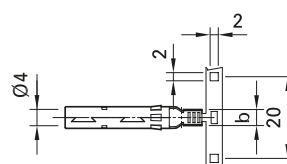
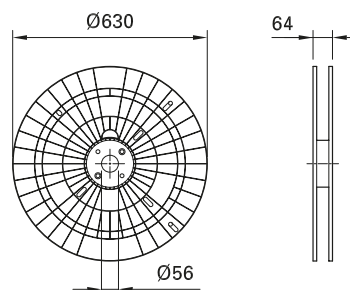

Order No.	Type	Female cable coupler	Male cable coupler	Conductor cross section			Crimping tool	Contacts per Reel <sup>2)</sup>	Approvals	
				mm <sup>2</sup>	AWG	b (mm)			TÜV	UL®
32.0020P2000-UR	PV-ADB4-EVO 2/2,5-UR	x		2.5	14	3	1)	2000	x	x
32.0021P2000-UR	PV-ADS4-EVO 2/2,5-UR		x	2.5	14	3	1)	2000		
32.0022P2000-UR	PV-ADB4-EVO 2/6-UR	x		4.0; 6.0	12; 10	5	1)	2000		
32.0023P2000-UR	PV-ADS4-EVO 2/6-UR		x	4.0; 6.0	12; 10	5	1)	2000		

**Note:**

For more detailed information concerning the suitable cable gland range, please consult MA285.



Sealing caps page 53

Unlocking tool page 58



Assembly Instructions MA285

[www.staubli.com/electrical](http://www.staubli.com/electrical)

- Feeder bands for fully automatic assembly
- Tools specially designed for MC4-Evo2 available for automatic crimping
- Process reliability as result of specially developed supply reel

Technical data	
Connector system	Ø 4 mm
Rated voltage	1500 V DC (TÜV) 1500 V DC (UL)
Rated current TÜV	32 A (2.5 mm <sup>2</sup> / 14 AWG) 42 A (4.0 mm <sup>2</sup> / 12 AWG) 47 A (6.0 mm <sup>2</sup> / 10 AWG)
Rated impulse voltage	8 kV (1500 V)
Ambient temperature range	-40°C...+85°C (TÜV) -40°C...+90°C (UL)
Upper limiting temperature	115°C
Degree of protection, mated unmated	IP65; IP68 (1m/1h) IP2X
Overvoltage category/Pollution degree	CATIII/3
Contact resistance of plug connectors	≤ 0.2 mΩ
Safety class	II
Contact system	MULTILAM
Type of termination	Crimping
Contact material	Copper, tin plated
Insulation material	PA
Locking system (UL)	Locking type
Flame class	UL94-V0
TÜV-Rheinland certified, in accordance with IEC 62852 UL recognized component, in accordance with UL 6703	R60118815  E343181

<sup>1)</sup> Information about a semi-automatic crimp device or assembly device on request

<sup>2)</sup> Reel type subject to alterations

# Branch socket, branch plug MC4

PV-AZB4

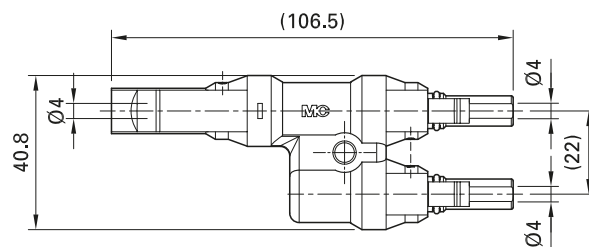

PV-AZS4

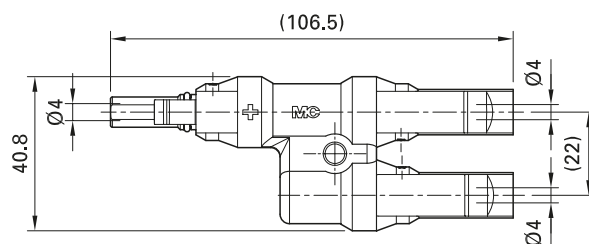

Order No.	Type	Description	Approvals
32.0018	PV-AZB4	Branch socket	
32.0019	PV-AZS4	Branch plug	



Sealing caps page 53

Unlocking tool page 58



Assembly Instructions MA250

[www.staubli.com/electrical](http://www.staubli.com/electrical)

- For a safe and simple parallel or serial-parallel connection of PV-modules.
- Pluggable with single-pole Stäubli PV-cable coupler MC4. Unmated connections must be protected by sealing caps.

Technical data	
Connector system	Ø 4 mm
Rated voltage	1500 V DC (UL)
Rated current	50 A
Rated impulse voltage	12 kV
Ambient temperature range	-40°C...+85°C (UL)
Upper limiting temperature	105°C (Stäubli)
Degree of protection, mated unmated	IP67 IP2X
Overvoltage category/Pollution degree	CATIII/2
Contact resistance of plug connectors	≤0.5 mΩ
Safety class	II
Contact system	MULTILAM
Contact material	Copper, tin plated
Insulation material	PC
Locking system (UL)	Locking type
Flame class	UL94-V0
UL recognized component, in accordance with UL 6703	E343181

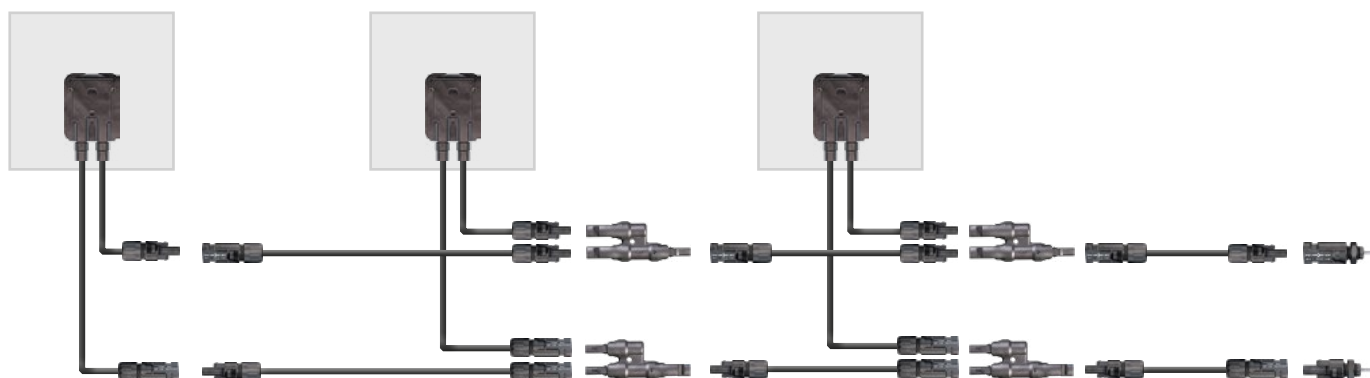

**JUNCTION BOXES**

# Advantages of the Stäubli junction boxes

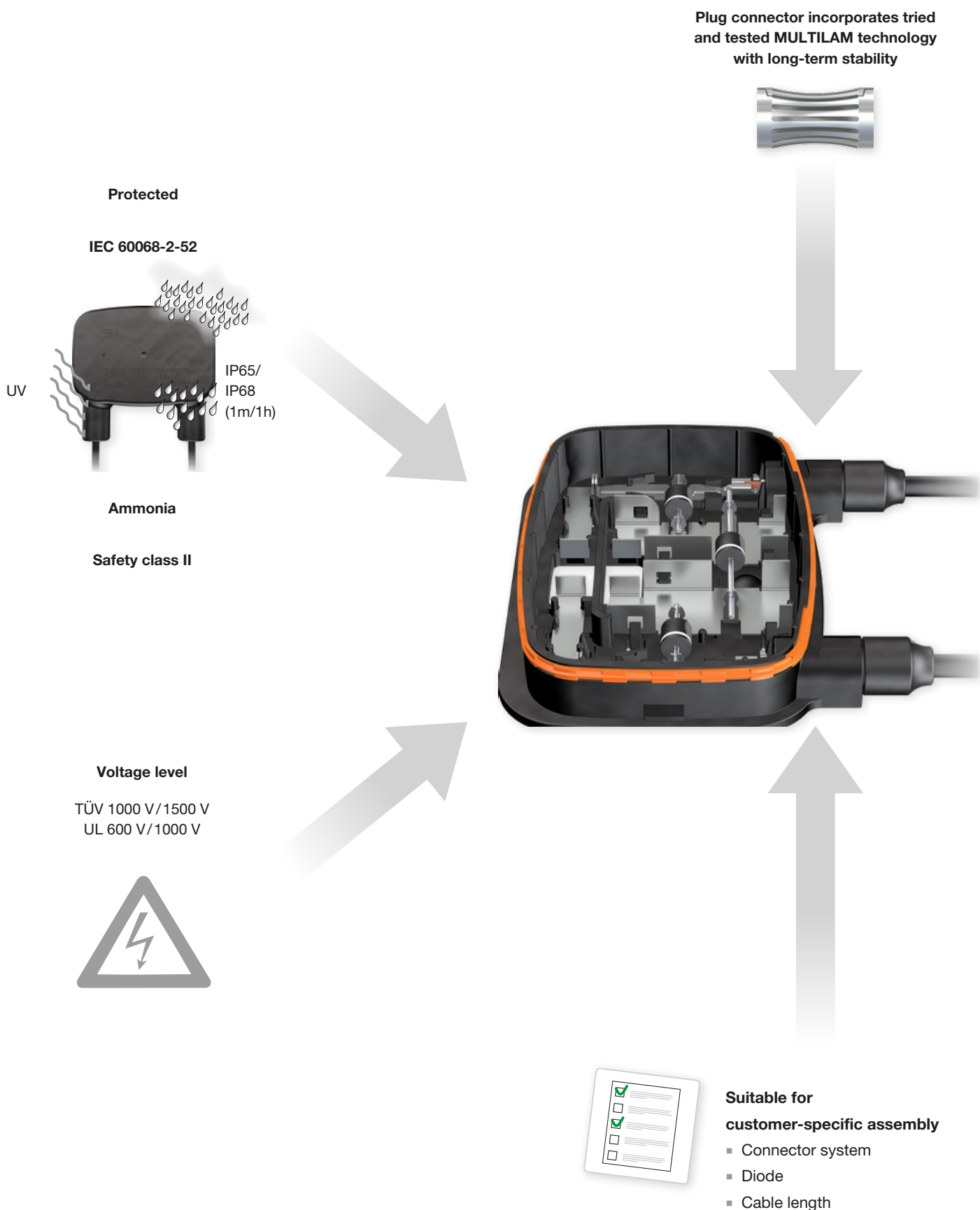



# 3

## Connection alternatives

- Welding
- Soldering
- Clamping



## Compatibility

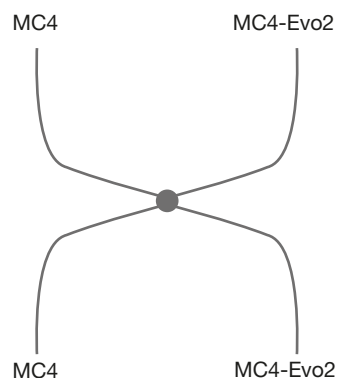

## Certificates

**TÜV** These products are certified by TÜV Rheinland LGA GmbH

**UL**® UL recognized

**PG** GOST-R

**CSA** CSA



## Assembly

Suitable for automated assembly



# Overview junction boxes

	Connector Ssystem	Approvals <sup>1)</sup>

## For crystalline modules

PV-JB/WL-H PV-JB/WL-V 	MC4 MC4-Evo2	TÜV   
PV-JB/MF... 	MC4	TÜV  

## For thin-film modules

TwinBox PV-JB/TB-... 	MC4	TÜV  
---	-----	---

## Legend





Mounting with silicone



Mounting with potting compound



Suitable for customer-specific assembly

Features	Salt mist spray test	Rated current	Rated voltage		max.	Bus ribbons	Number of diodes	Degree of protection, mated	Ambient temperature range	Poles	Page
			Category	A							
	V	10 <sup>2)</sup> 12	1500	1000	4	Welding Soldering Clamping	3	IP65 -40...+85 -40...+40	2	36 38	
	-	12 30 <sup>3)</sup>	1000	1000	4	Welding Soldering	3	IP65 IP68 -40...+105 -40...+85	2	40	
	-	25	1500	600	1	Welding	0	IP65 IP68 -40...+90 -40...+40	1	42	



Suitable for automated assembly

<sup>1)</sup> Certifications are in some cases limited to specific types or still pending. Details are given on the relevant product pages

<sup>2)</sup> Available equipped with alternative bypass diode, on inquiry

<sup>3)</sup> Without bypass diode

# PV junction box PV-JB/WL-H

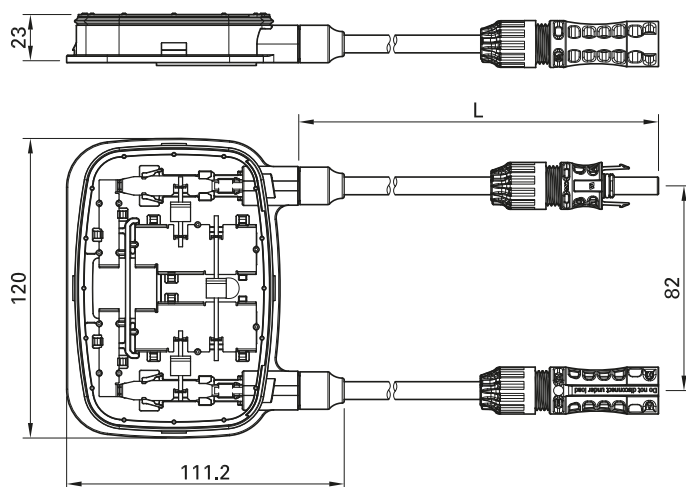

Order No.	Type	Connection of the bus ribbons		Cable cross section mm <sup>2</sup>	Length of cable (L) cm	Cable type	Rated voltage		Approvals		
		WS <sup>1)</sup>	C <sup>1)</sup>				V (TÜV)	V (UL)	TÜV	UL <sup>® 2)</sup>	SP
32.7956-100	PV-JB/WL-H-02-F-1-C	x		4	100	Flex-Sol-Evo-TX	1500	-	x		
32.7957-100	PV-JB/WL-H-02-F-1-C		x								
32.7895-100-UR	PV-JB/WL-H-02-D-1-WS	x		4	100	BETAflam <sup>®</sup>	1500	1000	x	x	x
32.7896-100-UR	PV-JB/WL-H-02-D-1-C		x								
32.7897-100-UR	PV-JB/WL-H-02-B-1-WS	x		4	100	Byson	1000	1000		x	x
32.7898-100-UR	PV-JB/WL-H-02-B-1-C		x								



Sealing caps page 53

Unlocking tool page 58



Assembly Instructions MA269

[www.staubli.com/electrical](http://www.staubli.com/electrical)

- Junction box for electrical connection of horizontal ribbon conductors on crystalline modules.
- The low profile construction of the box allows it to be installed directly under the module frame. Ribbon termination is achieved by welding, soldering, or, optionally, by terminal clips.
- The box is fixed to the panel with silicone RTV. Additional protection given by the projecting cover, which prevents kinking of the cables at the point where they emerge from the cable gland.
- Custom versions on request (see page 62):
  - Individual lead lengths
- Connector types MC4 upon request
- Includes PSA tape strips for fixturing during installation.

Technical data	
Connector system	MC4-Evo2 <sup>3)</sup>
Rated current	12 A (Vishay VSB2045Y-M3) <sup>3)</sup>
Rated voltage	1000 V DC / 1500 V DC (TÜV) <sup>2)</sup> 600 V DC / 1000 V DC (UL) <sup>2)</sup>
Rated surge voltage	12 kV (1000 V) 16 kV (1500 V)
Maximum permitted operating voltage	< 80 V
Ambient temperature range	-40°C...+85°C
Upper limiting temperature	+105°C
Degree of protection, mated unmated	IP65 IP2X
Degree of pollution	3 (2 in the housing of the junction box)
Contact resistance of plug connectors	≤ 0.20 mΩ (MC4-Evo2) ≤ 0.25 mΩ (MC4)
Contact material	Copper, tin plated
Insulation material	PPE
Locking system plug connectors (UL)	Locking type (MC4; MC4-Evo2)
Safety class	III
Flame class	UL94-V0
Ammonia resistance (acc. to DLG)	1500 h, 70°C/70% RH, 750 ppm
Salt mist spray test, degree of severity 5	IEC 60068-2-52
TÜV-Rheinland certified according EN50548:2011+A1+A2	R60085113
TÜV-Rheinland certified according IEC 62790:2014	R60114433
UL recognized component, in accordance with UL 3730	E335016
Intended for Module type	Crystalline
Poles	2
Diodes	3
Number of bus ribbons	4
Orientation of bus ribbons	Horizontal
Connection of the bus ribbons	Welding/Soldering/Clamping
Installation	Silicone
Suitable for semi-automated assembly	Yes

<sup>1)</sup> WS Welding/Soldering  
C Clamping

<sup>2)</sup> Depending on cable type

<sup>3)</sup> Other versions on request, see page 62

# PV junction box PV-JB/WL-V

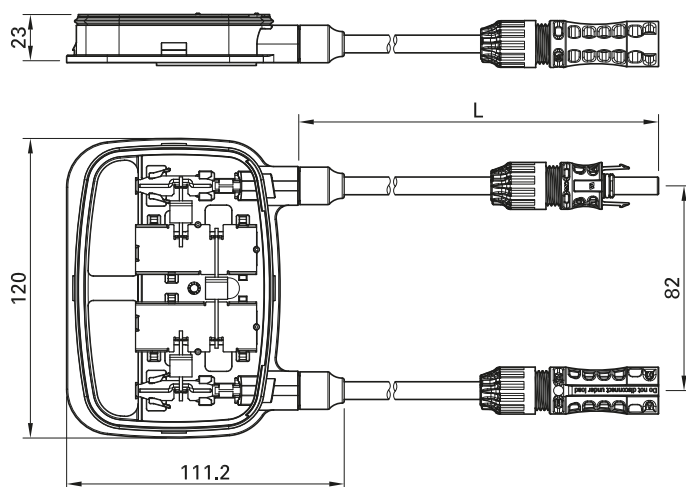
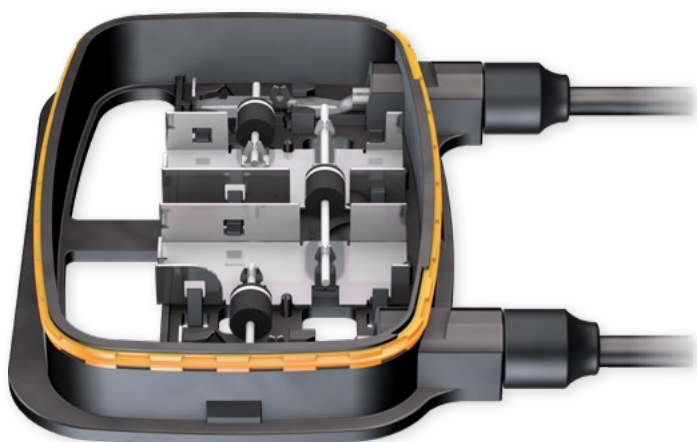

Order No.	Type	Connection of the bus ribbons		Cable cross section mm <sup>2</sup>	Length of cable (L) cm	Cable type	Rated voltage		Approvals		
		WS <sup>1)</sup>	C <sup>1)</sup>				V (TÜV)	V (UL)	TÜV	UL <sup>2)</sup>	SP
32.7954-100	PV-JB/WL-V-02-F-1-WS	x		4	100	Flex-Sol-Evo-TX	1500	-	x		
32.7955-100	PV-JB/WL-V-02-F-1-C		x								
32.7889-100-UR	PV-JB/WL-V-02-D-1-WS	x		4	100	BETAflam®	1500	1000	x	x	x
32.7890-100-UR	PV-JB/WL-V-02-D-1-C		x								
32.7891-100-UR	PV-JB/WL-V-02-B-1-WS	x		4	100	Byson	1000	1000		x	x
32.7892-100-UR	PV-JB/WL-V-02-B-1-C		x								



Sealing caps page 53

Unlocking tool page 58



Assembly Instructions MA274

[www.staubli.com/electrical](http://www.staubli.com/electrical)

- Junction box for electrical connection of vertical ribbon conductors on crystalline modules.
- The low profile construction of the box allows it to be installed directly under the module frame. Ribbon termination is achieved by welding, soldering, or, optionally, by terminal clips.
- The box is fixed to the panel with silicone. Additional protection given by the projecting cover, which prevents kinking of the cables at the point where they emerge from the cable sleeve.
- Custom versions on request (see page 62):
  - Individual lead lengths
- Connector types MC4 upon request
- Includes PSA tape strips for fixturing during installation.

Technical data	
Connector system	MC4-Evo2 <sup>3)</sup>
Rated current	12 A (Vishay VSB2045Y-M3) <sup>3)</sup>
Rated voltage	1000 V DC / 1500 V DC (TÜV) <sup>2)</sup> 600 V DC / 1000 V DC (UL) <sup>2)</sup>
Rated surge voltage	12 kV (1000 V) 16 kV (1500 V)
Maximum permitted operating voltage	< 80 V
Ambient temperature range	-40°C...+85°C
Upper limiting temperature	+105°C
Degree of protection, mated unmated	IP65 IP2X
Degree of pollution	3 (2 in the housing of the junction box)
Contact resistance of plug connectors	≤ 0.20 mΩ (MC4-Evo2) ≤ 0.25 mΩ (MC4)
Contact material	Copper, tin plated
Insulation material	PPE
Locking system plug connectors (UL)	Locking type (MC4; MC4-Evo2)
Safety class	III
Flame class	UL94-V0
Ammonia resistance (acc. to DLG)	1500 h, 70°C/70% RH, 750 ppm
Salt mist spray test, degree of severity 5	IEC 60068-2-52
TÜV-Rheinland certified according EN50548:2011+A1+A2	R60085113
TÜV-Rheinland certified according IEC 62790:2014	R60114433
UL recognized component, in accordance with UL 3730	E335016
Intended for Module type	Crystalline
Poles	2
Diodes	3
Number of bus ribbons	4
Connection of bus ribbons	Vertical
Connection of the bus ribbons	Welding/Soldering/Clamping
Installation	Silicone
Suitable for semi-automated assembly	Yes

<sup>1)</sup> WS Welding/Soldering  
C Clamping

<sup>2)</sup> Depending on cable type

<sup>3)</sup> Other versions on request, see page 62

# PV junction box PV-JB/MF...

## PV-JB/MF

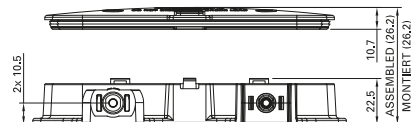
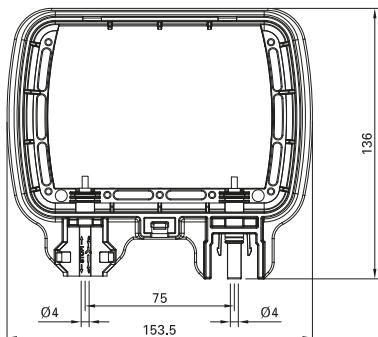

## PV-JB/MF-U01

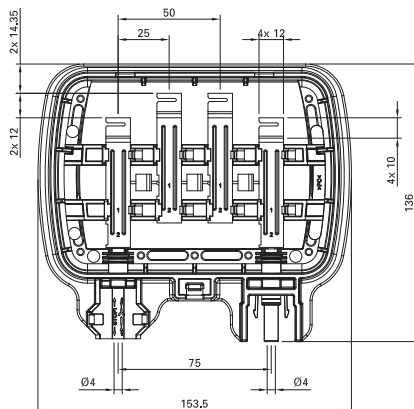

## PV-JB/MF-U02

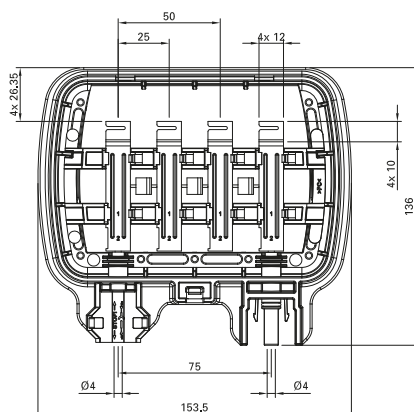

Order No.	Type	Rated current A	Rated voltage V	Bus Ribbons	Diode	Plug/Socket type
55000014	PV-JB/MF	30	1000	open	–	MC4
55000014-U01	PV-JB/MF-U01	12 <sup>1)</sup>	45	horizontal	3 × Schottky	MC4
55000014-U02	PV-JB/MF-U02	12 <sup>1)</sup>	45	vertical	3 × Schottky	MC4



Assembly Instructions MA281

[www.staubli.com/electrical](http://www.staubli.com/electrical)



- Our new open format junction box with integrated MC4 connector allows for countless possible configurations to suit a wide range of applications.
- Junction box can be supplied as complete solution or be purchased as stand-alone enclosure for complete customer generated solutions.
- Base enclosure PV-JB/MF carries certification, allowing for minimal re-test requirements.
- Available with several tiers of Engineering and Manufacturing support.
- Time and cost saving via cable-free, automation-friendly design and greater packaging density.

Connector system	
Connector system	MC4
Rated current	30 A (PV-JB/MF) 12 A (PV-JB/MF-U01, PV-JB/MF-U02)
Rated voltage	1000 V DC (UL3730) 1000 V DC (pol/⊕) (EN50548)
Rated surge voltage	12 kV (1000 V)
Maximum permitted operating voltage	45 V
Ambient temperature range	-40°C ...+105°C (TÜV) -40°C ...+85°C (UL)
Upper limiting temperature	+105°C
Degree of protection, mated unmated	IP68 (1m/1h) IP2X
Degree of pollution	3
Contact resistance of plug connectors	≤ 0.25 mΩ
Contact material	Copper/Copper alloy, tin plated
Insulation material	PPE/PS
Locking system plug connectors	Locking type
Safety class	II
Flame class	UL94-5VA
TÜV-Rheinland certified according EN 50548	R60090054
UL recognized component, in acc. with UL 3730	E350378
CSA certified according UL3730	250725
Intended for Module type	Crystalline
Poles	2
Diodes	3
Number of bus ribbons	4
Connection of bus ribbons	Vertical or horizontal
Connection of the bus ribbons	Soldering
Installation	Silicone
Suitable for automated assembly	Yes

<sup>1)</sup> Amperage based on Thermal Bypass Diode Test at 75°C ambient temperature according to EN50548 and Temperature Rise Test according to UL3730

# PV-Junction box TwinBox PV-JB/TB-...

## PV-JB/TB-ST4

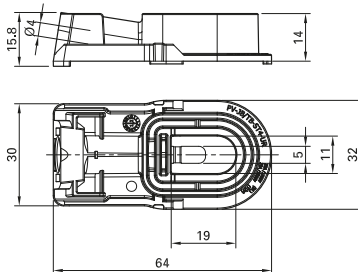

## PV-JB/TB-BT4

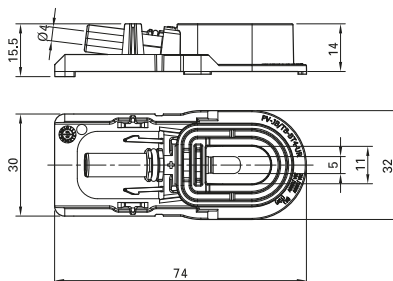

Order No.	Type	Description
32.7242-UR	PV-JB/TB-BT4-UR	Socket junction box, complete with cover and adhesive foil
32.7243-UR	PV-JB/TB-ST4-UR	Plug junction box, complete with cover and adhesive foil



Sealing caps page 53

Unlocking tool page 58



Assembly Instructions MA263

[www.staubli.com/electrical](http://www.staubli.com/electrical)

- Suitable for use with crystalline and thin-film PV modules
- Designed for fully automated assembly
- High dependability due to perfect matching of components, potting compound, silicone and adhesive foil.
- Compartment for electrical connection between box and panel hermetically sealed with potting compound.
- Compact design due to integration of the MC4 connection technology directly into the junction box.

#### Pre-assembled PV cables:

The connection of the TwinBox is achieved by using the MC4 connector system. Depending on the choice of cables and connectors various voltage systems may be realized: IEC 1000 V – 1500 V as well as UL 600 V – 1000 V.

Technical data	
Connector system	MC4
Rated current	25 A
Rated voltage <sup>1)</sup>	MC4: 1000 V DC / 1500 V DC <sup>2)</sup> (TÜV) 600 V DC (UL)
Rated surge voltage	16 kV
Maximum permitted operating voltage	1500 V
Upper limiting temperature	105°C (TÜV)
Ambient temperature range	-40°C...+90°C
Upper limiting temperature	+105°C
Degree of protection, mated unmated	IP65/IP68 (1 h/1 m) IP2X
Degree of pollution	3 mated
Contact resistance of plug connectors	≤0.25 mΩ
Contact material	Copper alloy, tin plated
Insulation material	PA
Locking system plug connectors	Locking type
Safety class	III
Flame class	UL94-V0
TÜV-Rheinland certified according EN 50548	R60110180
UL recognized component, in acc. with UL 3730	E335016
Intended for Module type	Thin film
Poles	1
Diodes	0
Number of bus ribbons	1
Connection of bus ribbons	Vertical or horizontal
Connection of the bus ribbons	Welding (UL, TÜV)/Soldering (TÜV)
Installation	Silicone and potting compound
Suitable for automated assembly	Yes

<sup>1)</sup> The rated voltage of the components and connectors used must be checked in the certificates.

<sup>2)</sup> 1500 V DC (IEC) according 2PFG2330: only for restricted access locations

# PV Cable Flex-Sol-Evo-DX...

MC FLEX-SOL-EVO-DX 2.5mm<sup>2</sup> TUEV EN50618 HI2222-K 1500VDC R 50359551 CE E470857 (UL) 14AWG PV Wire 105°C DRY 90°C WET 1000U OR 2000U SUN RES -40°C UW-1 VVMDD

MC FLEX-SOL-EVO-DX 4mm<sup>2</sup> TUEV EN50618 HI2222-K 1500VDC R 50359551 CE E470857 (UL) 12AWG PV Wire 105°C DRY 90°C WET 1000U OR 2000U SUN RES -40°C UW-1 VVMDD

MC FLEX-SOL-EVO-DX 6mm<sup>2</sup> TUEV EN50618 HI2222-K 1500VDC R 50359551 CE E470857 (UL) 10AWG PV Wire 105°C DRY 90°C WET 1000U OR 2000U SUN RES -40°C UW-1 VVMDD

MC FLEX-SOL-EVO-DX 10mm<sup>2</sup> TUEV EN50618 HI2222-K 1500VDC R 50359551 CE E470857 (UL) 8AWG PV Wire 105°C DRY 90°C WET 1000U OR 2000U SUN RES -40°C UW-1 VVMDD

Order No.	Type	Conductor cross section		Conductor Ø	Outer-Ø	Strand design	Conductor resistance	Approvals
		mm <sup>2</sup>						
62.7434-91021	FLEX-SOL-EVO-DX 2,5	2.5	14	2.0	5.94	47 x Ø 0.25	8.21	
62.7435-91021	FLEX-SOL-EVO-DX 4,0	4.0	12	2.4	6.35	52 x Ø 0.30	5.09	
62.7436-91021	FLEX-SOL-EVO-DX 6,0	6.0	10	3.0	6.97	78 x Ø 0.30	3.39	
62.7437-91021	FLEX-SOL-EVO-DX 10	10	8	4.1	8.57	77 x Ø 0.40	1.95	

Halogen free cross-linked polyolefin double layers photovoltaic cables for use at the photovoltaic power systems.

This cable can match with most PV-components like PV-junction boxes and PV-connectors, which have a rated voltage of 1500 V DC.

Technical data	
Nominal voltage	2000 V (UL) 1500 V/max. 1800 V (U0) (IEC)
Test voltage according to EN 50395-6	7.5 kV AC/15 kV DC (5 min.)
Rated current	41 A (2.5 mm <sup>2</sup> /14 AWG). 55 A (4.0 mm <sup>2</sup> /14 AWG). 70 A (6.0 mm <sup>2</sup> /14 AWG). 98 A (10 mm <sup>2</sup> /14 AWG)
Rated voltage	1500 V DC (IEC)/2000 V DC (UL) PV-Wire
Insulation resistance of the complete cable according to EN 50395-8.2	≥ 1000 MΩkm
Ambient temperature	-40°C ...+90°C
Maximum conductor temperature	max. +120°C
Bending radius    Dynamic Static	>5 × OD >4 × OD
Resistant to...	UV    Ozone    Hydrolysis
Resistance to... tested acc. to IEC 60811-2-1	Acids, alcalis and oil (IRM 902)
Isolation, acc. IEC 60332-1-2	Flame retardant with particularly low smoke emission
Conductor: fine-wire tinned copper strands Number larger than standard	Class 5 in accordance to IEC/EN 60228
Inner insulation (white) Sheath insulation, with colour patch (black)	XLPO (RAL9003) Polyolefin
Sheat color	Black
DEKRA certified UL recognized component	R50359551 UL E 470857

# PV Cable Flex-Sol-Evo-TX...

MC FLEX-SOL-EVO-TX 2.5mm<sup>2</sup> TUEV EN50618 H1Z2Z2-K 1500VDC R 50359551 CE VVMDD

MC FLEX-SOL-EVO-TX 4mm<sup>2</sup> TUEV EN50618 H1Z2Z2-K 1500VDC R 50359551 CE VVMDD

MC FLEX-SOL-EVO-TX 6mm<sup>2</sup> TUEV EN50618 H1Z2Z2-K 1500VDC R 50359551 CE VVMDD

MC FLEX-SOL-EVO-TX 10mm<sup>2</sup> TUEV EN50618 H1Z2Z2-K 1500VDC R 50359551 CE VVMDD

Order No.	Type	Conductor cross section	Conductor Ø	Outer-Ø	Strand design	Conductor resistance	Approvals
		mm <sup>2</sup>	mm	mm	Number x Ø mm	Ω/km 20°C	
62.7430-91021	FLEX-SOL-EVO-TX 2,5	2.5	2.0	5.0	47 x Ø 0.25	8.21	<b>TÜV</b>
62.7431-91021	FLEX-SOL-EVO-TX 4,0	4.0	2.4	5.4	52 x Ø 0.30	5.09	
62.7432-91021	FLEX-SOL-EVO-TX 6,0	6.0	3.0	6.0	78 x Ø 0.30	3.39	
62.7433-91021	FLEX-SOL-EVO-TX 10	10	4.1	7.2	77 x Ø 0.40	1.95	

Halogen free cross-linked polyolefin double layers photovoltaic cables for use at the photovoltaic power systems.

Technical data	
Nominal voltage	1500 V / max. 1800V (U0) (IEC)
Test voltage according to EN 50395-6	6.5 kV AC / 15 kV DC (5 min.)
Rated current	41 A (2.5 mm <sup>2</sup> ). 55 A (4.0 mm <sup>2</sup> ). 70 A (6.0 mm <sup>2</sup> ). 98 A (10 mm <sup>2</sup> )
Rated voltage	1500 V DC IEC
Insulation resistance of the complete cable according to EN 50395-8.2	≥ 1000 MΩkm
Ambient temperature	-40°C ... +90°C
Maximum conductor temperature	max. +120°C
Bending radius    Dynamic	>5 × OD
Static	>4 × OD
Resistant to...	UV    Ozone    Hydrolysis
Resistance to... tested acc. to IEC 60811-2-1	Acids, alcalis and oil (IRM 902)
Isolation, acc. IEC 60332-1-2	Flame retardant with particularly low smoke emission
Conductor: fine-wire tinned copper strands Number larger than standard	Wire class 5 in accordance to IEC/EN 60228
Inner insulation (white)	XLPE (RAL9003)
Sheath insulation, with colour patch (black)	Polyolefin
Sheat color	Black
TÜV Approval according EN50618	R50359551

# In-line-Fuse PV-K/ILF

PV-K/ILF...UL

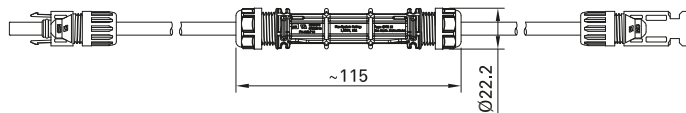

Order No.	Type	Safety	Type of connector/socket	Length	Approvals
		A/V	mm	cm	
55000140-0050UL	PV-K/ILF4/6N0050UL	4/1000	MC4	50	
55000127-0050UL	PV-K/ILF10/6N0050UL	10/1000			
55000128-0050UL	PV-K/ILF15/6N0050UL	15/1000			
55000129-0050UL	PV-K/ILF20/6N0050UL	20/1000			
55000130-0050UL	PV-K/ILF30/6N0050UL	30/1000			
55000189-0055UL	PV-K/1500ILF4/6N0055UL	4/1500	MC4	55	
55000190-0055UL	PV-K/1500ILF10/6N0055UL	10/1500			
55000191-0055UL	PV-K/1500ILF15/6N0055UL	15/1500			
55000192-0055UL	PV-K/1500ILF20/6N0055UL	20/1500			



The in-line fuse PV-K/ILF with a crimping connection guarantees a long-lasting, stable connection in comparison to conventional clip-in clamps:

- Minimal energy loss, low heat generation
  - Robust housing, safety class IP68
  - Cable cross section 10 AWG/6 mm<sup>2</sup>
  - Cable cTÜVus certified
- Two standard lengths:
  - 50 cm (1000 V) and 55 cm (1500 V)
  - Other lengths upon request

Technical data	
Connector system	MC4
Rated current fuse	1000 V: 4 A, 10 A, 15 A, 20 A, 30 A 1500 V: 4A , 10 A, 15 A, 20 A
Rated voltage fuse	1000 V (50 cm) 1500 V (55 cm)
Insulation test voltage	6600 V
Ambient temperature	-40°C...+50°C (UL9703)
Upper limiting temperature	105°C
Contact resistance of plug connectors	≤0.25 mΩ
Contact material	Copper alloy, tin-plated
Insulation material	PC/PA/PA + GF
Flame class	UL94-V0
UL-recognized components in accordance with UL 9703	E474445

ACCESSORIES

# Adapter leads

## Adapter test lead MC4

One end equipped with Stäubli PV connector, the other end with Ø 4 mm Stäubli safety plug for measuring instruments with

Ø 4 mm safety sockets ensuring safe current and voltage measuring on PV-modules and systems.

PV-AMLB4/150



PV-AMLS4/150



Order No.	Type	PV-plug	PV-socket	System	Colours
32.1198-150*	PV-AMLB4/150		x	MC4	21 23 29
32.1199-150*	PV-AMLS4/150	x		MC4	21 22

Technical data	
Connector system	MC4
Rated voltage	1000 V DC
Rated current	19 A
Conductor cross section	1 mm <sup>2</sup>
Cable length	150 cm
Cable insulation	PVC
Overvoltage category/Pollution degree	CATIII/2

\* Add the desired colour code



Sealing caps page 53

# Test socket and plug MC4

Special construction with gold plated contacts for test and measurement to achieve higher mating cycles.

**Without locking system.**

PV-KBT4II-P AU



PV-KST4II-P AU



Order No.	Type	Socket	Plug	Suitable for	 Assembly instruction
32.0044	PV-KBT4II-P AU	x		PV-KST4..., PV-ADSP4-S2..., PV-AZS4, PV-AZB4	MA260
32.0045	PV-KST4II-P AU		x	PV-KBT4..., PV-ADBP4-S2..., PV-AZS4, PV-AZB4	MA260

Technical data	
Connector system	MC4
Rated voltage	1000 V DC
Rated current	30 A (10 AWG/4 mm <sup>2</sup> )
Test voltage	6 kV (50 Hz, 1 min.)
Conductor cross section	2.5 mm <sup>2</sup> ; 4 mm <sup>2</sup> ; (14 AWG; 12 AWG; 10 AWG)
Degree of protection, unmated	IP2X
Overvoltage category/Pollution degree	CATIII/2
Contact resistance of plug connectors	≤0.25 mΩ
Contact material	Copper, gold plated
Insulation material	PC/PA

# Test plugs

## Test plug MC4

This test plug is used to control the correct location of the MC4 contact in the insulation.

### PV-PST



Order No.	Type	 Assembly instruction
32.6028	PV-PST	MA231, MA260, MA275

## Test plug MC4-Evo2

This test plug is used to control the correct location of the MC4-Evo2 contact in the insulation.

### PV-EVO-PST



Order No.	Type	 Assembly instruction
32.6073	PV-EVO-PST	MA273

# Sealing caps

## Sealing caps MC4, MC4-Evo2 and MC4-EvoAC

Sealing caps for tight sealing of unplugged PV connectors.

**PV-BVK4**

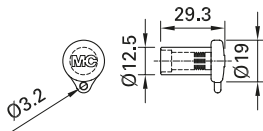

**PV-SVK4**

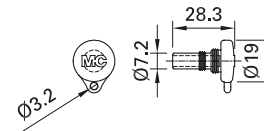

**PV-BVK-EVO AC**

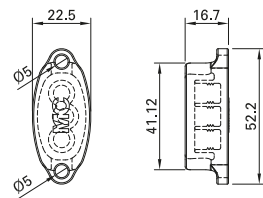

**PV-SVK-EVO AC**

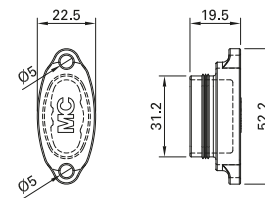

Order No	Type	Suitable for plug side	Suitable for socket side	System
32.0716	PV-BVK4		x	MC4, MC4-Evo2
32.0717	PV-SVK4	x		MC4, MC4-Evo2
32.0748	PV-BVK-EVO AC		x	MC4-EvoAC
32.0749	PV-SVK-EVO AC	x		MC4-EvoAC

### Technical data

Material	TPE
Degree of protection, mated	IP67



Assembly Instructions MA258

[www.staubli.com/electrical](http://www.staubli.com/electrical)

TOOLS

# Assembly tools

## Stripping pliers PV-AZM-...

With length stop for conductor cross sections 1.5 mm<sup>2</sup>, 2.5 mm<sup>2</sup>, 4 mm<sup>2</sup>, 6 mm<sup>2</sup> and 10 mm<sup>2</sup>. Specially adapted for the Flex-Sol-Evo... PV cable, for stripping small cable quantities on the roof.

### PV-AZM-...



Order No.	Type	Designation	for cable cross sections	 Assembly instruction
			mm <sup>2</sup>	
<b>32.6027-156</b>	PV-AZM-156	Pliers with Insert	1.5; 2.5; 4; 6	MA231, MA260, MA267
<b>32.6027-410</b>	PV-AZM-410	Pliers with Insert	4; 6; 10	MA231, MA267

### Individual parts

PV-M-AZM-156

PV-M-AZM-410



<b>32.6057-156</b>	PV-M-AZM-156	Insert	1.5; 2.5; 4; 6	MA231, MA260, MA267
<b>32.6057-410</b>	PV-M-AZM-410	Insert	4; 6; 10	MA231, MA267

## Crimping pliers for industrial use PV-CZ...

Only the tools stated below may be used for the assembly of UL- and TÜV-approved products.

These are suited for the processing of high numbers of pieces and can be adjusted to the product to be processed with the help of

changeable locators and crimp inserts.

PV-CZM...



Order No.	Type	Designation	Crimp range		suitable for		MA Assembly instruction
			mm <sup>2</sup>	AWG	MC4	MC4-Evo2	
32.6020-18100	PV-CZM-18100	Crimping pliers incl. locator and insert	1.5; 2.5; 4	14; 12	x		MA251
32.6020-19100	PV-CZM-19100		2.5; 4; 6	14; 12; 10	x		MA251
32.6020-20100	PV-CZM-20100		4; 10	–	x		MA251
32.6020-21100	PV-CZM-21100		6; 10	–	x		MA251
32.6020-22100	PV-CZM-22100		–	12; 10; 8	x		MA251
32.6020-40100	PV-CZM-40100		1.5; 2.5; 4	16; 14; 12		x	MA251
32.6020-41100	PV-CZM-41100		2.5; 4; 6	14; 12; 10		x	MA251
32.6020-42100	PV-CZM-42100		4; 10	12; 8		x	MA251

### Individual parts, only for PV-CZM...

PV-ES-CZM-18100

PV-ES-CZM-19100

PV-ES-CZM-20100

PV-ES-CZM-21100



PV-LOC



32.6021-18100	PV-ES-CZM-18100	Insert	1.5; 2.5; 4	14; 12	x		MA251
32.6021-19100	PV-ES-CZM-19100	Insert	2.5; 4; 6	14; 12; 10	x		MA251
32.6021-20100	PV-ES-CZM-20100	Insert	4; 10	–	x		MA251
32.6021-21100	PV-ES-CZM-21100	Insert	6; 10	–	x		MA251
32.6021-22100	PV-ES-CZM-22100	Insert	–	12; 10; 8	x		MA251
32.6021-40100	PV-ES-CZM-40100	Insert	1.5; 2.5; 4	16; 14; 12		x	MA251
32.6021-41100	PV-ES-CZM-41100	Insert	2.5; 4; 6	14; 12; 10		x	MA251
32.6021-42100	PV-ES-CZM-42100	Insert	4; 10	12; 8		x	MA251
32.6040	PV-LOC	Locator	universal		x		MA251
32.6055	PV-LOC-B	Locator	–	12; 10; 8	x		MA251
32.6056	PV-LOC-C	Locator	universal			x	MA251

## Crimping pliers for private use PV-CZM-BS

Suitable for the assembly of products approved by TÜV in small amounts.

Complete tool for the assembly of the original MC4.

### PV-CZM-BS



Order No.	Type	Crimp range		suitable for		 Assembly instruction
		mm <sup>2</sup>	AWG	MC4	MC4-Evo2	
<b>32.6025</b>	PV-CZM-BS	2.5; 4; 6	–	×		MA289



## Socket wrench insert

Stäubli recommends these socket wrench inserts for a simple and safe assembly of the panel receptacles.

### PV-WZ-AD/GWD

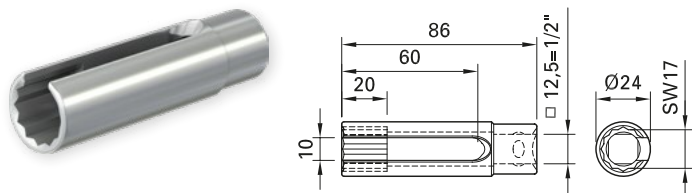

### PV-SSE-AD4

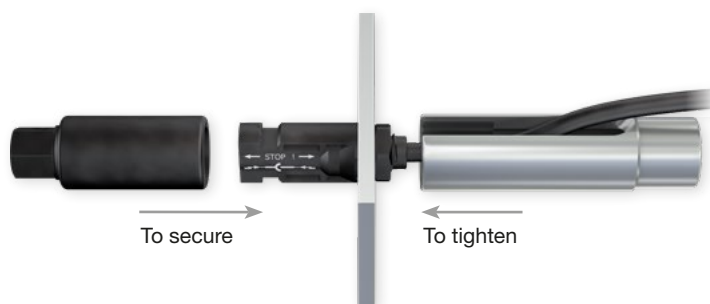
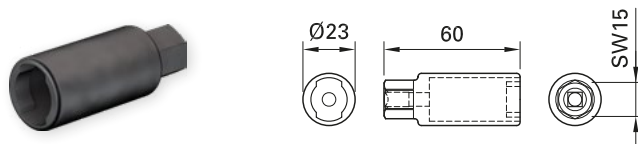

Order No.	Type	suitable for panel receptacles	 Assembly instruction
32.6006	PV-WZ-AD/GWD	MC4	MA231, MA260, MA275
32.6026	PV-SSE-AD4	MC4	MA231, MA260, MA275

## Open-end spanner and unlocking tool MC4, MC4-Evo2 and MC4-EvoAC

To tighten and unscrew the cable gland and to open the locking device of the connection.

PV-MS

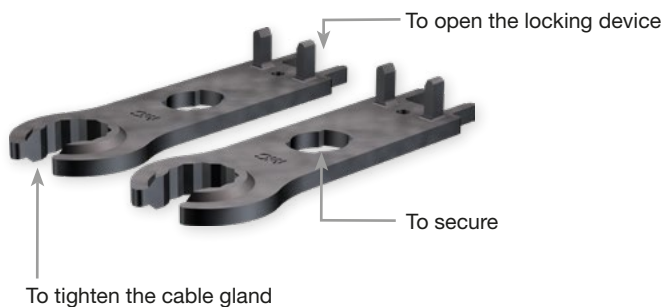

PV-MS-PLS



PV-MS-PLS/G



PV-MS-EVO AC



Order No.	Type	Description	suitable for	 Assembly instruction
32.6024	PV-MS	Open-end spanner set (consisting of 2 open-end spanners), plastics	MC4	MA231, MA260
32.6058	PV-MS-PLS	Assembly and unlocking tool, incl. belt pouch (consisting of 2 open-end spanners), metal	MC4 MC4-Evo2	MA270
9410888400	PV-MS-PLS/G	Unlocking tool	MC4 MC4-Evo2	
32.6075	PV-MS-EVO AC	Unlocking tool	MC4-EvoAC	MA284

## MC4 Tool case PV-WZ4-SET

Plastic case with tools for assembly of PV connectors.

### PV-WZ4-SET



Pos.	Order No.	Type	Designation	Width	Height	Depth
	<b>32.6019</b>	PV-WZ4-SET	Case, incl. Pos. 1-3	345 mm	90 mm	275 mm

#### Einzelteile

1	<b>32.6020-19100</b>	PV-CZM-19100	Crimping pliers 2.5 mm <sup>2</sup> ; 4 mm <sup>2</sup> ; 6 mm <sup>2</sup> /14 AWG; 12 AWG; 10 AWG
2	<b>32.6024</b>	PV-MS	Open-end spanner set
3	-	-	Plastic box

#### Optional

	<b>32.6006</b>	PV-WZ-AD/GWD	Socket wrench insert
	<b>32.6026</b>	PV-SSE-AD4	Socket wrench insert
	<b>32.6021-...</b>	PV-ES-CZM-...	Insert, see page 55
	<b>...</b>	PV-LOC...	Locator, see page 55
	<b>32.6027-156</b>	PV-AZM-156	Stripping pliers
	<b>32.6027-410</b>	PV-AZM-410	Stripping pliers

FORMS

# Cable assemblies

According to customer request

<input type="text"/>	Quantity	<input type="checkbox"/>	Order	<input type="checkbox"/>	Quotation	<input type="text"/>	Reference
----------------------	----------	--------------------------	-------	--------------------------	-----------	----------------------	-----------

<p><b>Side 1</b></p> <div style="border: 1px solid black; padding: 5px; margin-bottom: 10px;"> <p><b>MC4</b></p> <p><input type="checkbox"/> PV-KBT4 </p> <p><input type="checkbox"/> PV-KST4 </p> <p><input type="checkbox"/> PV-ADBP4-S2 </p> <p><input type="checkbox"/> PV-ADSP4-S2 </p> </div> <div style="border: 1px solid black; padding: 5px; margin-bottom: 10px;"> <p><b>MC4-Evo2</b></p> <p><input type="checkbox"/> PV-KBT4-EVO 2 </p> <p><input type="checkbox"/> PV-KST4-EVO 2 </p> <p><input type="checkbox"/> PV-ADB4-EVO 2 </p> <p><input type="checkbox"/> PV-ADS4-EVO 2 </p> </div> <div style="border: 1px solid black; padding: 5px; margin-bottom: 10px;"> <p><input type="checkbox"/> <b>Cable lug</b></p> <p><input type="checkbox"/> Ø <input type="text"/> </p> <p><input type="checkbox"/> Ø <input type="text"/> </p> <p>Isolation: <input type="checkbox"/> without <input type="checkbox"/> with</p> </div> <div style="border: 1px solid black; padding: 5px; margin-bottom: 10px;"> <p><input type="checkbox"/> <b>Partial stripping</b> </p> <p>Length <input type="text"/> (max. 45 mm)</p> </div> <p><input type="checkbox"/> <b>Not stripped</b> </p> <p><input type="checkbox"/> <b>Other</b> <input type="text"/></p>	<p><b>Cable</b></p> <p><b>Cable cross section (mm<sup>2</sup>):</b></p> <p><input type="checkbox"/> 2.5 <input type="checkbox"/> 4 <input type="checkbox"/> 6 <input type="checkbox"/> 10</p> <p><b>Length of cable<sup>1)</sup>:</b></p> <p><input type="text"/> cm</p> <div style="border: 1px solid black; padding: 5px; margin-top: 10px;"> <p><b>Sender</b></p> <p>Company _____</p> <p>_____</p> <p>Name _____</p> <p>_____</p> <p>Department _____</p> <p>Address _____</p> <p>_____</p> <p>_____</p> <p>Tel. _____</p> <p>Fax _____</p> <p>E-Mail _____</p> <p>Date _____</p> <p>Signature _____</p> <p>Other _____</p> <p>_____</p> </div>	<p><b>Side 2</b></p> <div style="border: 1px solid black; padding: 5px; margin-bottom: 10px;"> <p><b>MC4</b></p> <p> PV-KBT4 <input type="checkbox"/></p> <p> PV-KST4 <input type="checkbox"/></p> <p> PV-ADBP4-S2 <input type="checkbox"/></p> <p> PV-ADSP4-S2 <input type="checkbox"/></p> </div> <div style="border: 1px solid black; padding: 5px; margin-bottom: 10px;"> <p><b>MC4-Evo2</b></p> <p> PV-KBT4-EVO 2 <input type="checkbox"/></p> <p> PV-KST4-EVO 2 <input type="checkbox"/></p> <p> PV-ADB4-EVO 2 <input type="checkbox"/></p> <p> PV-ADS4-EVO 2 <input type="checkbox"/></p> </div> <div style="border: 1px solid black; padding: 5px; margin-bottom: 10px;"> <p><b>Cable lug</b> <input type="checkbox"/></p> <p> Ø <input type="text"/></p> <p> Ø <input type="text"/></p> <p>Isolation: <input type="checkbox"/> without <input type="checkbox"/> with</p> </div> <div style="border: 1px solid black; padding: 5px; margin-bottom: 10px;"> <p> <b>Partial stripping</b> <input type="checkbox"/></p> <p>Length <input type="text"/> (max. 45 mm)</p> </div> <p> <b>Not stripped</b> <input type="checkbox"/></p> <p><input type="checkbox"/> <b>Other</b> <input type="text"/></p>
--	---	--



Interactive form: [www.staubli.com/electrical](http://www.staubli.com/electrical)

> Downloads > Online-Forms

<sup>1)</sup> Definition, see page 61

# Definition of cable lengths

## Cable lengths of cable assemblies

For ordering ready made leads, the cable length L is defined as in the examples shown below.

**Female cable coupler**



**Male cable coupler**



**Cable lug**

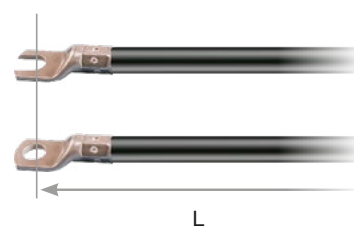

**Female panel receptacle**

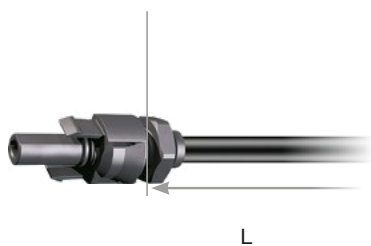

**Male panel receptacle**

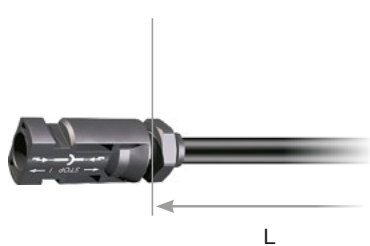

**Complete or partial stripping**

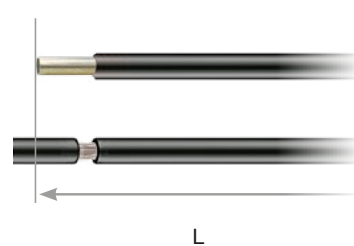

# Junction box PV-JB/WL-...

According to customer request

<input type="text"/>	Quantity	<input type="checkbox"/>	Order	<input type="checkbox"/>	Quotation	<input type="text"/>	Reference
----------------------	----------	--------------------------	-------	--------------------------	-----------	----------------------	-----------

<input type="checkbox"/> MC4 <input type="checkbox"/> PV-JB/WL-H <input type="checkbox"/> PV-JB/WL-V		Cross section <b>4 mm<sup>2</sup></b>	Length in cm L1 <input type="text"/> (min. 25 cm) L2 <input type="text"/> (min. 25 cm)	Cable type <input type="checkbox"/> BETAflam® <input type="checkbox"/> Byson <input type="checkbox"/> Flex-Sol-Evo-TX
--	--	--	--	--

<input type="checkbox"/> MC4-Evo2 <input type="checkbox"/> PV-JB/WL-H <input type="checkbox"/> PV-JB/WL-V		Cross section <b>4 mm<sup>2</sup></b>	Length in cm L1 <input type="text"/> (min. 25 cm) L2 <input type="text"/> (min. 25 cm)	Cable type <input type="checkbox"/> BETAflam® <input type="checkbox"/> Byson <input type="checkbox"/> Flex-Sol-Evo-TX
---	--	--	--	--

Module current IMPP: <input type="text"/> A	Module short-circuit current Isc: <input type="text"/> A	Diode type <input type="text"/>	Other <input type="text"/>
--	---	------------------------------------	-------------------------------

<b>Sender</b>	
Company <input type="text"/>	
Name <input type="text"/>	Department <input type="text"/>
Address <input type="text"/>	
Tel. <input type="text"/>	Fax <input type="text"/>
E-Mail <input type="text"/>	
Date <input type="text"/>	Signature <input type="text"/>



Interactive form: [www.staubli.com/electrical](http://www.staubli.com/electrical)

> Downloads > Online-Forms

# Innovations

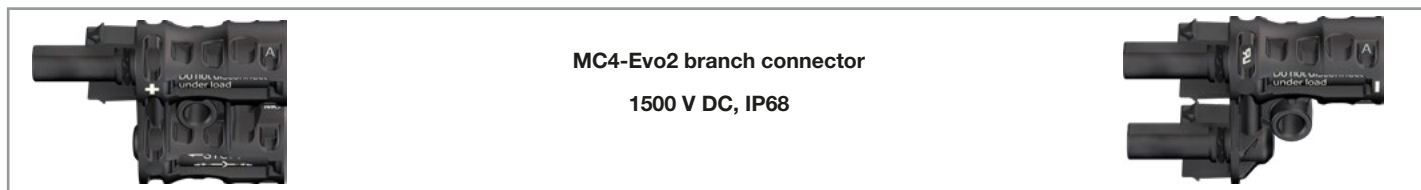

**MC4-Evo2 branch connector**  
1500 V DC, IP68

- With the MC4-Evo2 Stäubli is expanding its 1500-V portfolio.
- The new branch connector completes the MC4-Evo2 plug connector family
- MULTILAM technology
- For a secure and assembly-friendly parallel or parallel-serial cabling of PV modules
- Pluggable with a unipolar Stäubli PV connector from the MC4 connector family

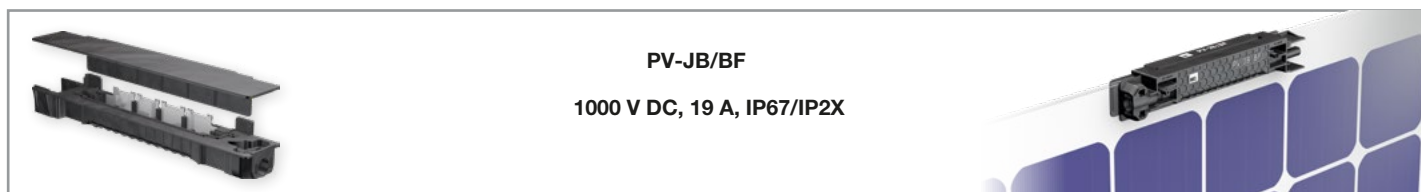

**PV-JB/BF**  
1000 V DC, 19 A, IP67/IP2X

- The PV-JB/BF requires no extended non-productive glass area as for example with a C-shaped cut.
- The slim PV-JB/BF can be mounted on the top without covering cells.
- Variable module thickness: 5-9 mm.
- Integrated MC4 mating faces allow to use just the requested cable length.
- The heat management of the PV-JB/BF allows a bypass current of 17 A with ribbons not exceeding 90 °C, which reduces EVA degradation.

# Customized solutions

## PV junction box – Example



Technical data	
Rated voltage	1000 V DC (IEC)
Rated current	2.5 A – 10 A
Degree of protection, mated	IP65
Connection of the bus ribbons	Soldering
Installation	Adhesive pad Silicone
TÜV Rheinland certified, EN 50548 + A1	R60090328

## APPENDIX

## General information

Users wishing to employ products listed in the catalogue for applications we have not considered are themselves responsible for making certain that the products comply with standards other than those stated.

**Changes/Provisos**

All data, illustrations and drawings in the catalogue have been carefully checked. They are in accordance with our experience to date, but no responsibility can be accepted for errors. We also reserve the right to make modifica-

tions for design and safety reasons. When designing equipment incorporating our components, it is therefore advisable not to rely solely on the data in the catalogue but to consult us to make sure this information is up to date. We shall be pleased to advise you.

## Technical information

**Crimped terminations**

For termination of the conductors to the crimping sleeves of the PV plug connectors we recommend using the stated crimping tools. For UL certified products only the tools mentioned can be used for self-assembly according to the assembly instructions. The crimping sleeves are designed for highly flexible conductors of the stated cross-section ranges. The use of flexible conductors is possible. It is advantageous to use tinned conductors.

**Connecting cables**

To ensure that the cable outlets of the PV plug connectors are sufficiently watertight, connecting cables of the specified diameter ranges for the insulating casings must be used.

**Laying conditions**

When laying the PV leads, avoid having the connecting cable resting on a sharp edge at the exit from the PV connector. We recommend observing the minimum bending radius of the connecting cables.

**Plugging cycles**

The maximum life of the PV connectors is 100 plugging cycles.

**Rated current**

See derating diagram

**Max. system voltage**

Is the maximum voltage for which the components of the PV plug connector system may be used and are rated in accordance with IEC 60664-1.

**Contact resistance**

is the resistance at the point of contact between two contact surfaces.

**Test voltage**

Is the voltage at which the new components of the PV plug connector system are tested under defined conditions without breakdown or arcing.

**Unplugging under load**

PV plug connections must not be unplugged while under load. Plugging and unplugging while under tension is permitted.

**Protection against weather**

Sealing caps must be used to protect unplugged PV-connectors from moisture and dirt.

**Positioning of the junction box**

The junction box must be fixed on the PV module in such a position that the cable outlets of the junction box point downwards when in use.



# Further technical data on leads

## Smallest Permissible Bend Radii

VDE 0298, part 3, stipulates minimum permissible bend radii of leads. In the following table, the minimum bend radii are shown for fixed and mobile flexible leads.

Bend radii	
Rated voltage	> 600 V
Fixed	6 d
Mobile	10 d

d = Outside diameter of lead

## Why tinned multistrand copperwires?

If bright-soft copper stranded wires are exposed to temperatures > 90°C, this can result in discoloration of the copper and an impairment of its soldering properties.

Reactions between the copper and the insulating material may also occur which have a deleterious effect on the mechanical properties of the flexible leads.

Nominal cross section	Conductor resistance
mm <sup>2</sup>	Ω/km
1.5	13.3
2.5	7.98
4.0	4.95
6.0	3.30
10	1.91

## Resistance of conductor at 20°C for class 5 Cu conductors

The following table shows the conductor resistance for fine-stranded copper wires with bare individual strands at 20°C in relation to the nominal cross-section according to IEC/EN 60228.

## Table mm<sup>2</sup> / AWG

The nominal cross-section of our multi-strand wires is stated in sq. mm. The following chart gives an indication of their comparability with corresponding AWG values.<sup>1)</sup>

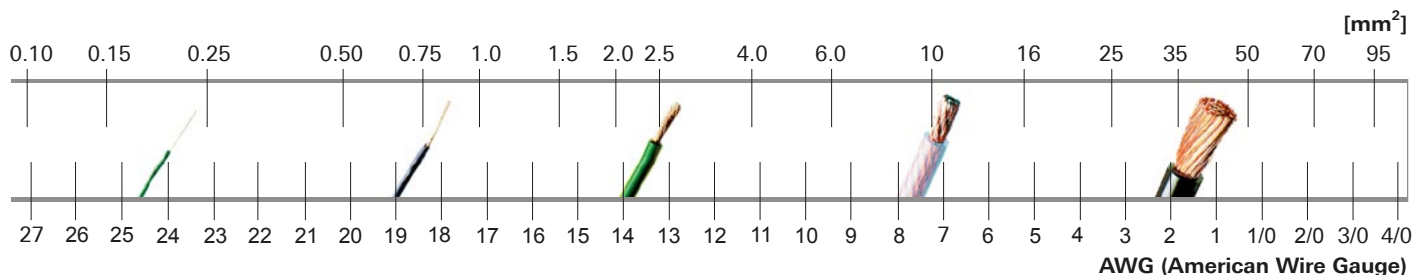

<sup>1)</sup> The chart is based on values for stranded wires given in UL 758 "UL Standard for Safety for Appliance Wiring Material".

# Index

Type	Page
FLEX-SOL-EVO-DX 2,5	46
FLEX-SOL-EVO-DX 4,0	46
FLEX-SOL-EVO-DX 6,0	46
FLEX-SOL-EVO-DX 10	46
FLEX-SOL-EVO-TX 2,5	48
FLEX-SOL-EVO-TX 4,0	48
FLEX-SOL-EVO-TX 6,0	48
FLEX-SOL-EVO-TX 10	48
MC-K1,5Y3/PV-AC1/BI/100	22
MC-K1,5Y3/PV-AC1/SI/100	22
MC-K1,5Z3/PV-AC1/BII/100	22
MC-K1,5Z3/PV-AC1/SII/100	22
MC-K2,5Y3/PV-AC1/BII/100	22
MC-K2,5Y3/PV-AC1/SII/100	22
MC-K2,5Z3/PV-AC1/BII/100	22
MC-K2,5Z3/PV-AC1/SII/100	22
MC-K4Y3/PV-AC1/BIII/100	22
MC-K4Y3/PV-AC1/SIII/100	22
MC-K4Z3/PV-AC1/BIII/100	22
MC-K4Z3/PV-AC1/SIII/100	22
PV-ADB4-EVO 2/2,5-UR	28, 30
PV-ADB4-EVO 2/6-UR	28, 30
PV-ADBP4/2,5	24, 26
PV-ADBP4/6	24, 26
PV-ADBP4-S2/10	24, 26
PV-ADS4-EVO 2/2,5-UR	28, 30
PV-ADS4-EVO 2/6-UR	28, 30
PV-ADSP4/2,5	24, 26
PV-ADSP4/6	24, 26
PV-ADSP4-S2/10	24, 26
PV-AMLB4/150	52
PV-AMLS4/150	52
PV-AZB4	32
PV-AZM-156	56, 61
PV-AZM-410	56, 61
PV-AZS4	32
PV-BVK4	55
PV-BVK-EVO AC	55
PV-CZ	58
PV-CZM-18100	57
PV-CZM-19100	57, 61
PV-CZM-20100	57
PV-CZM-21100	57
PV-CZM-22100	57

Type	Page
PV-CZM-40100	57
PV-CZM-41100	57
PV-CZM-42100	57
PV-CZM-BS	58
PV-ES-CZM-18100	57
PV-ES-CZM-19100	57
PV-ES-CZM-20100	57
PV-ES-CZM-21100	57
PV-ES-CZM-22100	57
PV-ES-CZM-40100	57
PV-ES-CZM-41100	57
PV-ES-CZM-42100	57
PV-EVO-PST	54
PV-JB/MF	42
PV-JB/MF-U01	42
PV-JB/MF-U02	42
PV-JB/TB-BT4-UR	44
PV-JB/TB-ST4-UR	44
PV-JB/WL-H-02-B-1-C	38
PV-JB/WL-H-02-B-1-WS	38
PV-JB/WL-H-02-D-1-C	38
PV-JB/WL-H-02-D-1-WS	38
PV-JB/WL-H-02-F-1-C	38
PV-JB/WL-V-02-B-1-C	40
PV-JB/WL-V-02-B-1-WS	40
PV-JB/WL-V-02-D-1-C	40
PV-JB/WL-V-02-D-1-WS	40
PV-JB/WL-V-02-F-1-C	40
PV-JB/WL-V-02-F-1-WS	40
PV-K/1500ILF4/6N0050UL	50
PV-K/1500ILF10/6N0050UL	50
PV-K/1500ILF15/6N0050UL	50
PV-K/1500ILF20/6N0050UL	50
PV-KBT4/2,5II-UR	14, 16
PV-KBT4/2,5I-UR	14, 16
PV-KBT4/2,5X-UR	14, 16
PV-KBT4/6II-UR	14, 16
PV-KBT4/6I-UR	14, 16
PV-KBT4/6X-UR	14, 16
PV-KBT4/8II-UR	14
PV-KBT4/10II	14, 16
PV-KBT4-EVO 2/2,5II-UR	18, 20
PV-KBT4-EVO 2/2,5I-UR	18, 20
PV-KBT4-EVO 2/6II-UR	18, 20

Type	Page
PV-KBT4-EVO 2/6I-UR	18, 20
PV-KBT4-EVO 2/10II-UR	18, 20
PV-KBT4II-P AU	53
PV-K/ILF4/6N0050UL	50
PV-K/ILF10/6N0050UL	50
PV-K/ILF15/6N0050UL	50
PV-K/ILF20/6N0050UL	50
PV-K/ILF30/6N0050UL	50
PV-KST4/2,5II-UR	14, 16
PV-KST4/2,5I-UR	14, 16
PV-KST4/2,5X-UR	14, 16
PV-KST4/6II-UR	14, 16
PV-KST4/6I-UR	14, 16
PV-KST4/6X-UR	14, 16
PV-KST4/8II-UR	14
PV-KST4/10II	14, 16
PV-KST4-EVO 2/2,5II-UR	18, 20
PV-KST4-EVO 2/2,5I-UR	18, 20
PV-KST4-EVO 2/6II-UR	18, 20
PV-KST4-EVO 2/6I-UR	18, 20
PV-KST4-EVO 2/10II-UR	18, 20
PV-KST4II-P AU	53
PV-LOC	57
PV-LOC-B	57
PV-M-AZM-156	56
PV-M-AZM-410	56
PV-MS	60, 61
PV-MS-EVO AC	60
PV-MS-PLS	60
PV-MS-PLS/G	60
PV-PST	54
PV-SSE-AD4	59, 61
PV-SVK4	55
PV-SVK-EVO AC	55
PV-WZ4-SET	61
PV-WZ-AD/GWD	59, 61



■ Stäubli Units    ○ Agents

# Global presence of the Stäubli Group

[www.staubli.com](http://www.staubli.com)

## X-ON Electronics

Largest Supplier of Electrical and Electronic Components

*Click to view similar products for [staubli](#) manufacturer:*

Other Similar products are found below :

[23.3070-21,+ -22,+ -23,+ -24,+ -25](#) [61.7607-21 25M](#) [66.9706-21](#) [63.9358-22](#) [28.0127-10027](#) [49.0126-05023](#) [49.0126-20024](#) [28.0124-20029](#)  
[22.2633-23](#) [23.3020-28](#) [66.9407-05028](#) [49.7049-24](#) [23.0480-21](#) [60.7008-999-21](#) [61.7664-999-23](#) [61.7612-100-22](#) [14.0034-29](#) [23.0440-21](#)  
[28.0116-05022](#) [28.0116-05023](#) [24.0224-21](#) [65.9098-21](#) [64.9214-2122](#) [23.3060-24](#) [67.9799-22](#) [61.7607-29 25M](#) [23.3120-28](#) [49.0126-05024](#)  
[49.0126-05025](#) [49.0079-05023](#) [66.9392-15022](#) [66.9407-05027](#) [66.9408-10028](#) [67.9770-100-21](#) [22.1027 & 22.2380-23](#) [61.7611-100-33](#)  
[60.7018-100-21](#) [28.0116-20022](#) [28.0125-02522](#) [66.9328-25](#) [65.3314-21,+ -22,+ -23,+ -24,+ -25,+ -29](#) [22.3006-21](#) [28.0055-05024](#) [23.3120-20](#)  
[49.0126-02525](#) [28.0126-05024](#) [28.0126-20020](#) [28.0124-05020](#) [28.0125-05021](#) [28.0125-20023](#)