

Multi-Contact

MC

STÄUBLI

Medical technology Main catalog

Medicalline | Medical industry connectors



STÄUBLI ELECTRICAL CONNECTORS

Long-term solutions – Expert connections



Stäubli Electrical Connectors is a leading international manufacturer of high-quality electrical connector systems. We are part of the Stäubli Group which offers mechatronics solutions for electrical connectors, liquid and gas couplings, robots and textile machinery.

Stäubli develops, produces, sells and maintains products for markets with high productivity standards. As recognized specialists, our focus is always on solutions and customers. Many new developments got their start here and have begun to make their way around the world.

Businesses and customers count on our commitment and our active support when dealing with unusual problems. With us, you are entering into a long-term partnership built on reliability, dynamism, and exceptional quality in both products and services.

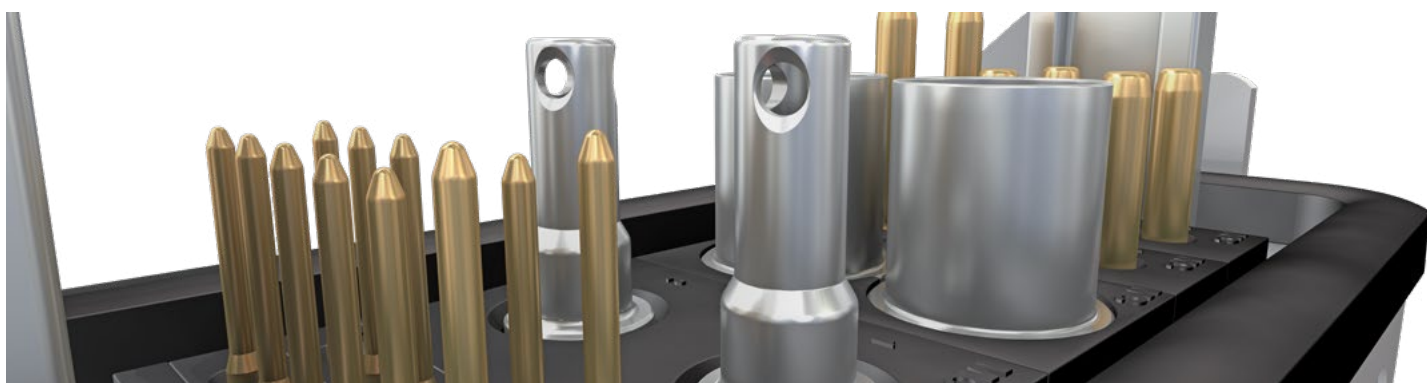

Applications and advantages

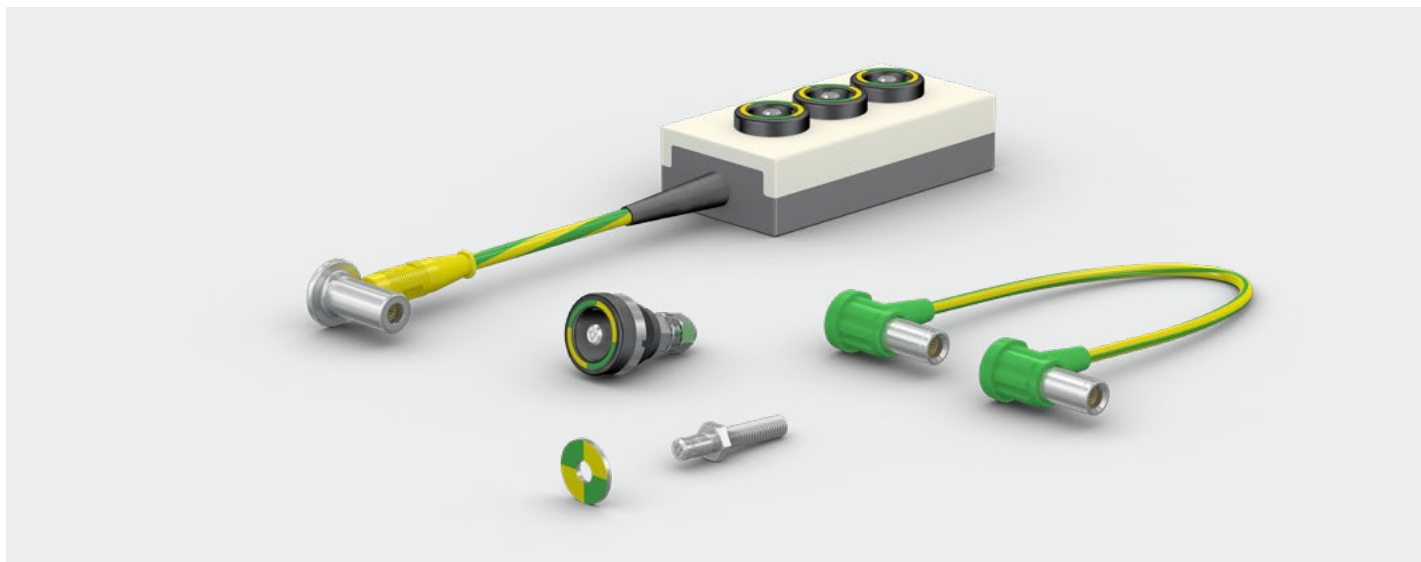

In the field of medical technology, it is especially important that all components be highly reliable – in intensive care units, for example, people’s lives often depend directly on the correct operation of the medical devices being used.

Our decades of experience, the high-quality standards applied to all Stäubli products, and our proven MULTILAM technology en-

sure the highest levels of safety, reliability and corrosion resistance for products from our medical electronics portfolio. The silicon and TPE used as insulation materials in our products can be steam-sterilized, and are therefore well-adapted to the specific requirements of medical device applications.

The raw materials we use are carefully selected.

This catalog presents our range of connectors and cables specially designed for use in medical devices. Alongside our standard items, we also introduce examples of pre-assembled cables. We also produce custom solutions based on customer requests. Ask us for more information!

Contents

Page 6	General information
Page 7	Touch-protected Ø 1.5 mm and Ø 2 mm connectors
Page 9	Touch-protected Ø 1.5 mm panel-mount terminals (DIN 42802)
Page 10	Touch-protected Ø 2 mm connectors (E-DIN 42802-2)
Page 11	Touch-protected Ø 2 mm panel-mount terminals (E-DIN 42802-2)
Page 13	Touch-protected Ø 2 mm adapters (E-DIN 42802-2)
Page 14	Examples for assembled connecting leads with Ø 2 mm connectors (E-DIN 42802-2)
Page 15	Connectors and connecting leads for potential equalization according to DIN 42801
Page 16	Connecting leads for potential equalization in accordance with DIN 42801
Page 21	Multistrand wires for medical applications
Page 22	Tools
Page 23	Index

UNLIMITED POSSIBILITIES FOR CONTACT SOLUTIONS

MULTILAM Technology



MULTILAM are specially formed and resilient contact elements. All Stäubli Electrical Connectors products benefit from the unique and outstanding performance of the **MULTILAM** Technology.

Thanks to their constant spring pressure, **MULTILAM** louvers ensure continuous contact with the contact surface, resulting in a constantly low contact resistance.

MULTILAM Technology allows to find solutions for connectors within the severest constraints and in certain products for up to 1 million mating cycles.

This makes the **MULTILAM** Technology the best choice for applications with demanding requirements:

- Reliable and longlife operation due to constantly high performance
- Safe operation under highest environmental demands on temperature, vibration and shock
- Suitable for data and signal contacts as well as high-current connectors
- Automated solutions with a high number of mating cycles

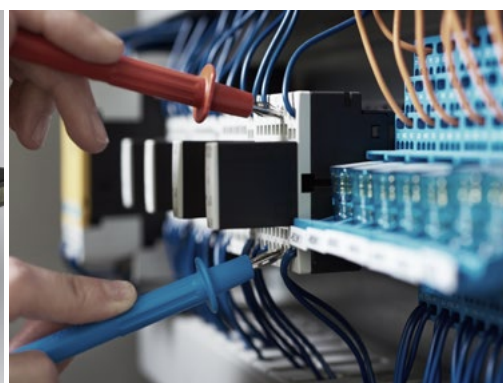

General information

Length and color code

For articles that are available in more than one length or color, please write the desired length and color codes after the order number instead of the spaces “□” and “*” used in the catalogue.

20	green-yellow	26	violet
21	black	27	brown
22	red	28	grey
23	blue	29	white
24	yellow	33	transparent
25	green	34	natural

Changes / Provisos

All data, illustrations and drawings in the catalogue have been carefully checked. They are in accordance with our experience to date, but no responsibility can be accepted for errors. We also reserve the right to make modifications for design and safety reasons. When designing equipment incorporating our components, it is therefore advisable not to rely solely on the data in the catalogue but to consult us to make sure this information is up to date. We shall be pleased to advise you.

Copyright

The use of this catalogue for any other purpose, in whatever form, without our prior written consent is not permitted.

RoHS ready

Directive 2011/65/EU on the restriction of the use of certain hazardous substances in electrical and electronic equipment including supplement pursuant to Commission Delegated Directive (EU) 2015/863.

All items listed in the catalog comply with the requirements.

Reach

Regulation (EC) No 1907/2006 for Registration, Evaluation, Authorisation and Restriction of Chemicals.

The items listed in the catalog contain none of the substances named in Annex XVII of the Directive above the permissible maximum concentration. Stäubli monitors the further development of the SVHC (substance of very high concern) and the substances named in Annex XIV.

Surface treatment

Au	Gold-plated
Ni	Nickel-plated
PVC	Lead insulation: PVC
SIL	Lead insulation: Silicone
TPE	Lead insulation: TPE
134°C SSS	Sterilizable up to 134 °C

Symbols



Accessories or special tools exist for this product.



The assembly instruction MA000 is available for this product.

Touch-protected Ø 1.5 mm and Ø 2 mm connectors

Standard DIN 42802¹⁾ lays down requirements for connectors for use in medical technology. These requirements concern the design of Ø 1.5 mm and Ø 2 mm connectors with regard to touch protection, material, geometry and withdrawal force.

In the illustrations below the principal characteristics of these various connection systems are presented together, for comparison, with the touch-protected Ø 2 mm plug connection system conforming to IEC/

EN 61010-031 from our Test & Measureline product group.

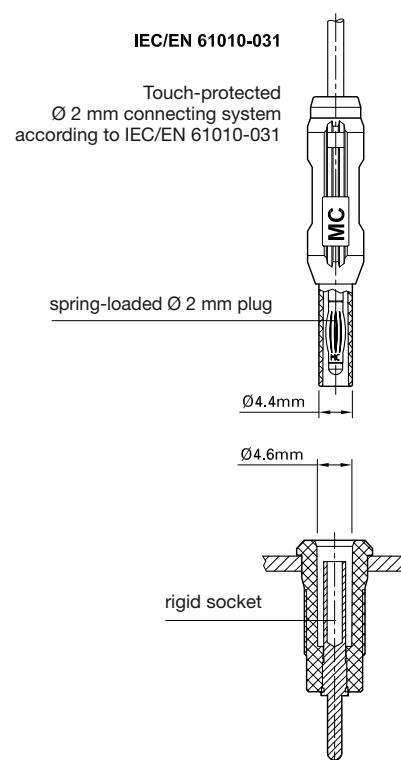
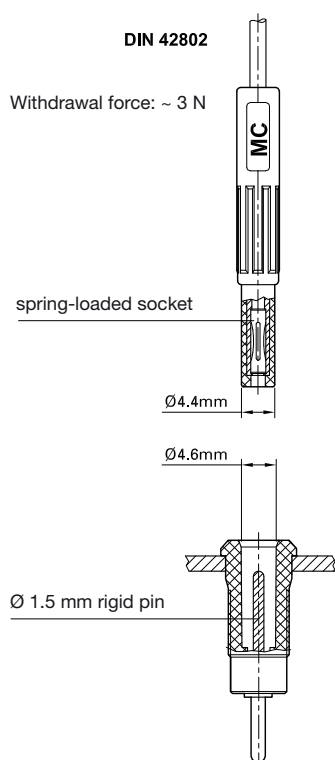

Application DIN 42802:

For the transmission of body action voltages (leading away from the patient, e.g. for ECG, heart monitor).

Application IEC/EN 61010-031:

For test and measuring applications e.g. in the electronics laboratory, where work is carried out in a limited space with voltages that are dangerous to touch.

In addition to the connectors in accordance with DIN 42802 and E-DIN 42802-2, in this catalogue we also offer other Ø 1.5 mm and Ø 2 mm connectors.

Other relevant standards:

- Standard IEC 60601-1 stipulates in paragraph 56.3c (contact points and connectors): "Leads with conductive connection to a patient are constructed such that no conductive connection remote from the patient can contact earth or hazardous voltages."
- In standard ANSI/AAMI EC53-1995 (American National Standard for ECG cables and leadwires), paragraph 4.2.1, the constructional requirements are defined to be in accordance with DIN 42802.

¹⁾ DIN 42802: "Connector, touch proof, for electromedical application"

MS1525-B MS155-B

In-line, gold-plated Ø 1.5 mm sockets with spring-loaded MULTILAM for self-assembly of connecting leads (compatible for mating

with terminals such as MEB1,5-R and ML-B1,5-R). The insulating material is suitable for steam sterilization. **Solder or crimp connection.**

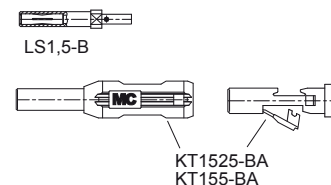
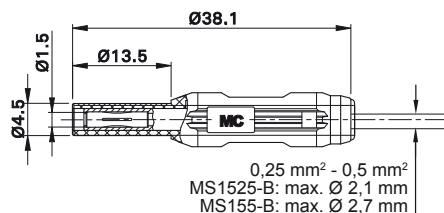

Order No.	Type	Withdrawal force	Insulation		* Colors
65.3321-*	MS1525-B	~ 3 N	PA	Au 134°C	21 22 23 24 25 29
65.3322-*	MS155-B	~ 3 N	PA	Au 134°C	21 22 23 24 25 29



Assembly instructions MAH531

www.staubli.com/electrical

MS1525-S

In-line, gold-plated Ø 1.5 mm rigid plugs, for self-assembly of connecting leads (compatible for mating with leads such as

MLK1,5-B...). The insulating material is suitable for steam sterilization. **Solder or crimp connection.**

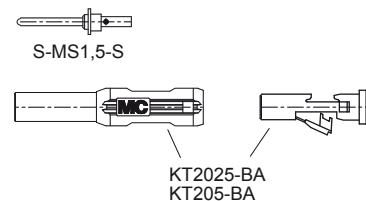
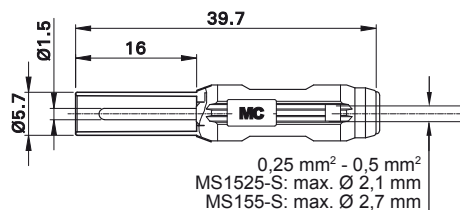

Order No.	Type	Insulation		* Colors
65.3339-*	MS1525-S	PA	Au 134°C	21 22 23 24 25 29



Assembly instructions MAH554

www.staubli.com/electrical

Touch-protected Ø 1.5 mm panel-mount terminals (DIN 42802)

MEB1,5-R

Insulated panel terminal according to DIN 42802. With rigid, gold-plated Ø 1.5 mm pin, accepting spring-loaded Ø 1.5 mm

sockets. The terminal is pressed into pre-drilled panels of plastic, metal etc. **Round connecting pin Ø 1.9 mm.**



Assembly instructions MAH510

www.staubli.com/electrical

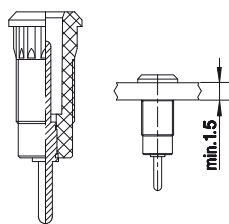
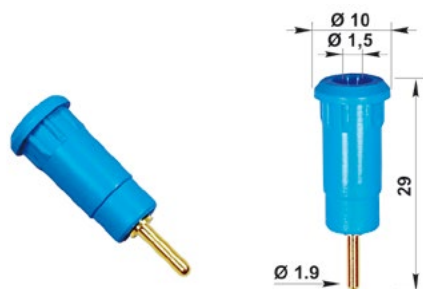

Panel drilling

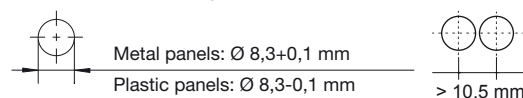

Order No.	Type	Connection		* Colors
65.3301-*	MEB1,5-R	Round connecting pin Ø 1.9 mm	Au	21 22 23 24 25 29

MLB1,5-R

Insulated panel terminal according to DIN 42802. With rigid, gold-plated Ø 1.5 mm pin, accepting spring-loaded Ø 1.5 mm

sockets. The terminal is surface-mounted or assembled flush into predrilled panels of plastic, metal etc. **Round connecting pin Ø 1.9 mm.**



Assembly instructions MAH511

www.staubli.com/electrical

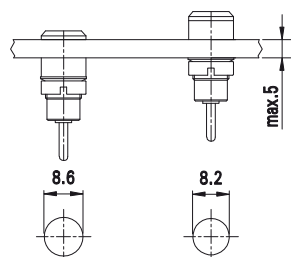
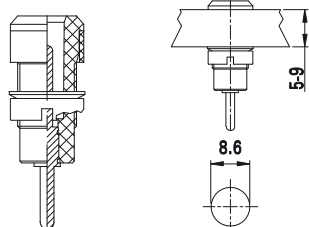

Panel drilling

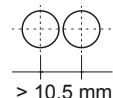

Order No.	Type	Connection		* Colors
65.3300-*	MLB1,5-R	Round connecting pin Ø 1.9 mm	Au	21 22 23 24 25 29

Component parts

25.0021	SS4	Tube spanner
25.0023	SS2-S	Tube spanner

Touch-protected Ø 2 mm connectors (E-DIN 42802-2)

MS2025-S MS205-S

In-line, gold-plated Ø 2 mm rigid plugs, for self-assembly of connecting leads. With rigid

insulating sleeve. The insulating material is suitable for steam sterilization. **Solder or crimp connection.**

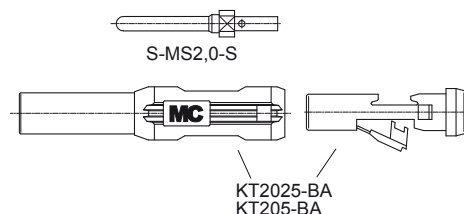
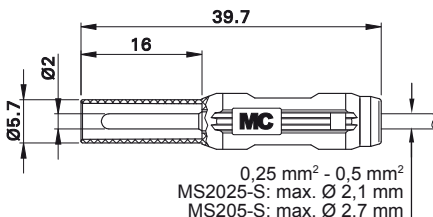

Order No.	Type	Insulation		* Colors
65.3324-*	MS2025-S	PA	Au 134°C	21 22 23 24 25 29
65.3314-*	MS205-S	PA	Au 134°C	21 22 23 24 25 29



Assembly instructions MAH531

www.staubli.com/electrical

MS225-B MS255-B

In-line, gold-plated Ø 2 mm sockets with spring-loaded MULTILAM, accepting rigid

Ø 2 mm plugs with rigid insulating sleeve for self-assembly of connecting leads. **Solder or crimp connection.**

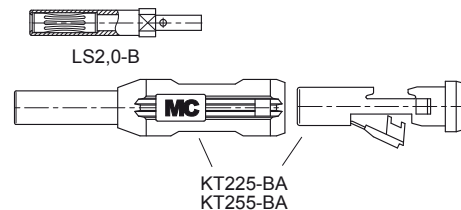
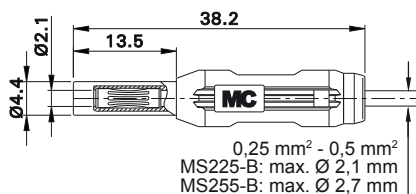

Order No.	Type	Withdrawal force	Insulation		* Colors
65.3349-*	MS255-B	> 10 N	PA	Au 134°C	21 22 23 24 25 29



Assembly instructions MAH554

www.staubli.com/electrical

Touch-protected Ø 2 mm panel-mount terminals (E-DIN 42802-2)

MEB2,0-R MEB2,0-L

Insulated gold-plated Ø 2 mm panel terminals with spring-loaded MULTILAM, accepting rigid Ø 2 mm plugs with rigid

insulating sleeve. The terminals are pressed into predrilled panels of plastic, metal etc. **Round connecting pin Ø 1.9 mm or solder connection.**

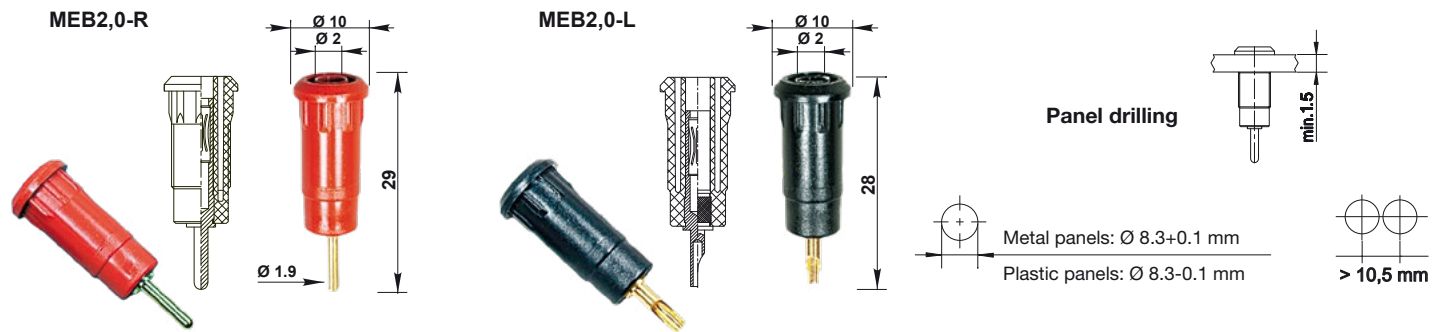

Order No.	Type	Withdrawal force	Connection		* Colors
65.3303-*	MEB2,0-R	> 10 N	Round connecting pin Ø 1.9 mm	Au	21 22 23 24 25 29
65.3331-*	MEB2,0-L	> 10 N	Solder connection	Au	21 22 23 24 25 29



Assembly instructions MAH528

www.staubli.com/electrical

MLB2,0-R MLB2,0-L

Insulated gold-plated Ø 2 mm panel terminals with spring-loaded MULTILAM, accept-

ing rigid Ø 2 mm plugs with rigid insulating sleeve. The terminals are surface-mounted or assembled flush into predrilled panels of

plastic, metal etc. **Round connecting pin Ø 1.9 mm or solder connection.**

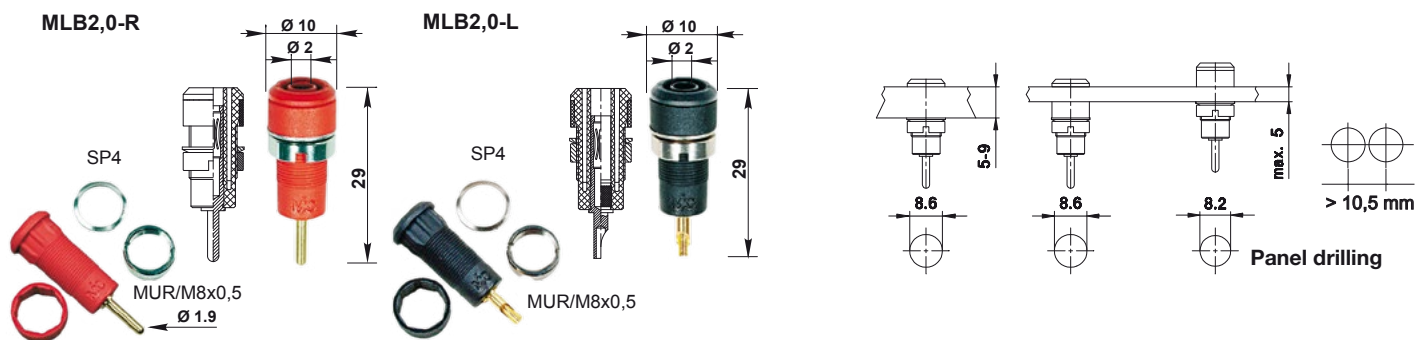

Order No.	Type	Withdrawal force	Connection		* Colors
65.3304-*	MLB2,0-R	> 10 N	Round connecting pin Ø 1.9 mm	Au	21 22 23 24 25 29
65.3332-*	MLB2,0-L	> 10 N	Solder connection	Au	21 22 23 24 25 29



Assembly instructions MAH527

www.staubli.com/electrical

Touch-protected Ø 2 mm adapters (E-DIN 42802-2)

MLA2

Adapter, made of gold-plated brass to fit in Ø 2 mm clamping sockets. Ø 2 mm socket

with spring-loaded MULTILAM in insulator accepting rigid Ø 2 mm plugs with rigid insulating sleeve according to E-DIN 42802-2.

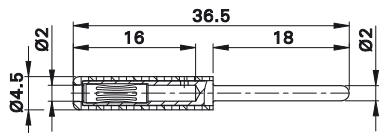

Order No.	Type	Withdrawal force		* Colors
20.0159-*	MLA2	> 10 N	Au	21 22 23 24 25 29

MLA2

Adapter, made of gold-plated brass can be screw-mounted into rigid Ø 2 mm sockets. The expandable Ø 2 mm plug of this adapter

can be locked into the socket by tightening the grub screw. Assembled, the adapter offers complete touch-proof protection. Ø 2 mm socket with spring-loaded MULTILAM

in insulator accepting rigid Ø 2 mm plugs with rigid insulating sleeve.

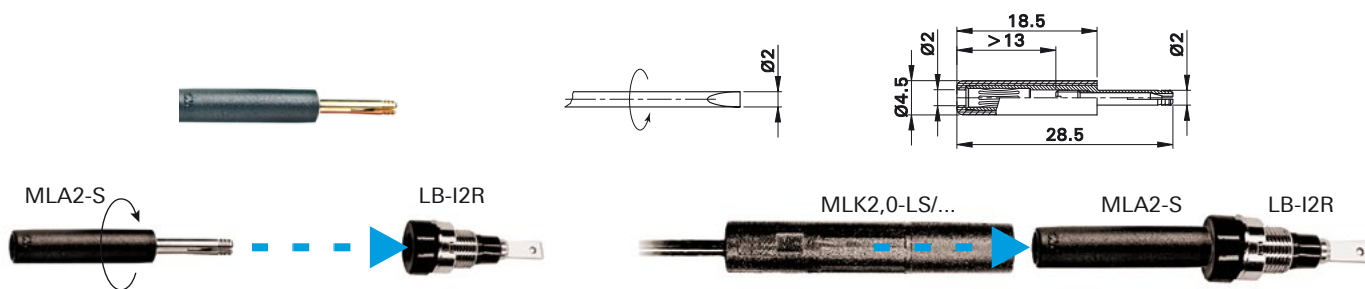

Non-touch-protected socket

Touch protected plug connection according to E-DIN 42802-2

Order No.	Type	Withdrawal force		* Colors
24.0159-*	MLA2-S	> 10 N	Au	21 22 23 24 25 29

Accessories

Screwdriver: Size 00



Assembly instructions MA160

www.staubli.com/electrical

Examples for assembled connecting leads with \varnothing 2 mm connectors (E-DIN 42802-2)

Connecting lead with axial, rigid, gold-plated \varnothing 2 mm plug. Highly flexible with TPE insulation.

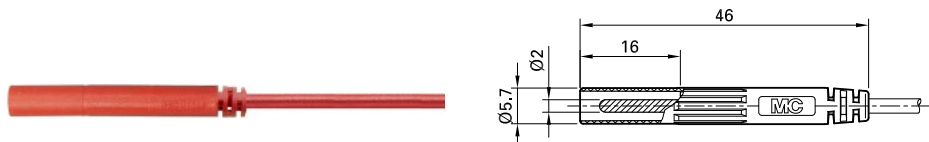

\varnothing 2 mm plug, gold-plated, TPE insulation, moulded

Order No.	Type	\varnothing 2 mm connector / other end	Lead cross section / type	
55.3305-□*	MLK2,0-LS/P	In-line plug, moulded / open lead	0.5 mm ² / PLAST-E 0,50 SN	<div style="display: flex; gap: 5px;"> <div style="border: 1px solid black; padding: 2px;">Au</div> <div style="border: 1px solid black; padding: 2px;">TPE</div> <div style="border: 1px solid black; padding: 2px;">134°C</div> </div>

Supplied lengths, colors, delivery times and prices on inquiry!

Needless to say, we also offer variants that are not presented here – ask us!

Connectors and connecting leads for potential equalization according to DIN 42801

The IEC 60364-7-710 standard requires that additional protective equipotential bonding be provided in all Group 1 and 2 medical locations.

The purpose of additional potential equalization is to equalise potentials between different metal parts that can be touched simultaneously, or to reduce differences of potential which can occur during operation between the bodies of medical electrical devices and conductive parts of other objects.

The Stäubli connector is specially shaped so as to prevent chance disconnection when used as intended, while allowing the lead to be removed without the need for tools.

The items for potential equalization listed in the catalog take into account the requirements on potential equalization conductors set in IEC 60601-1 and are also tested according to the DIN 42801 TÜV type.

The terminals are marked with symbol



in accordance with IEC 60417-5021, and with in the colors green-yellow.



TÜV Rheinland has tested this product to verify whether it meets the relevant safety requirements.

To ensure that products that have been tested and certified continue to be produced at the same level of quality, TÜV Rheinland inspects the production facility at regular intervals.

It verifies processes at the manufacturing facility, including e.g. the procurement of parts (supplier evaluation), individual processing steps, and inspection of finished products.

Relevant standards:

EC / DIN EN 60601-1:

Medical electrical equipment

– General requirements for safety.

IEC 60364-7-710:

Electrical installations of buildings – Requirements for special installations or locations – Medical locations.

DIN EN 793 (VDE 0750 Part 211):

Particular requirements for safety of medical supply units.

DIN 42801:

Connection bolts for equipotential bonding conductors.

DIN 42801 part 2:

Equipotential bonding conductors; connection sockets.

Medical standards:

To place a medical device on the market in any given country, it must be shown that the device is safe and reliable.

The usual process for this involves the use of established international standards.

For medical devices, the relevant standard is IEC 60601-1 and any supplements that apply in individual countries.

(USA: AAMI ES 60601-1

Canada: CSA C22.2 No. 60601-1

and in EU countries: EN 60601-1)

Connecting leads for potential equalization in accordance with DIN 42801

The purpose of additional potential equalization is to equalise potentials between different metal parts that can be touched simultaneously, or to reduce differences

of potential which can occur during operation between the bodies of medical electrical devices and conductive parts of other objects.

Our POAG socket is designed for screw lead termination so that no special tools (crimping pliers) are needed.

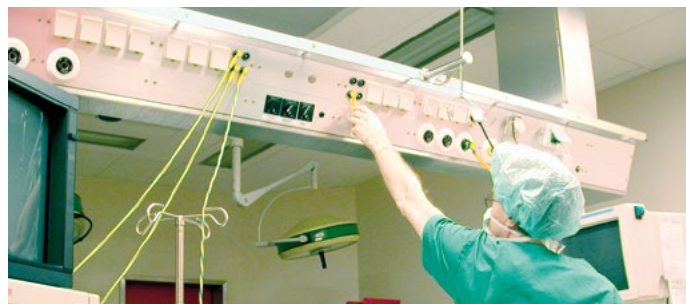

The use of high-quality components ensures dependable potential equalization in places where it is particularly important: in hospital facilities and medical practices.

We supply the new POAG socket separately for the self-assembly of potential equalization leads, as well as leads ready assembled with this socket.

The features of the new POAG socket at a glance:

- Screw connection is simply effected by means of a standard Allen key (no special tool needed)
- Good price-performance ratio of the POAG sockets and assembled leads
- Nickel-plated socket and gold-plated MULTILAM for dependable, durable contact
- Design in accordance with DIN 42801 part 2

POAG-KBT6-EC/...

Right-angled sockets for self-assembly of connecting leads for potential equaliza-

tion. Socket made of nickel-plated brass with MULTILAM made of gold-plated, hard-drawn copper alloy. Screw connec-

tion for lead cross sections 4.0 mm² and 6.0 mm².

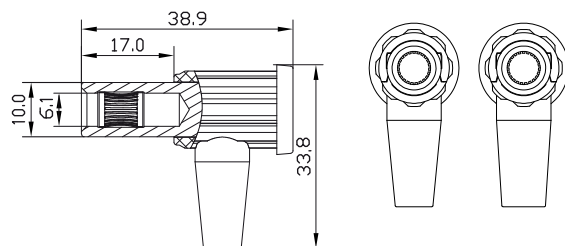

Order No.	Type	Connectable conductor cross-section		Insulation		Color
55.3220-20	POAG-KBT6-EC/4	4.0 mm ²	Ø 5.1 mm	PA	Ni TÜV ¹⁾	20
55.3225-20	POAG-KBT6-EC/6	6.0 mm ²	Ø 6.2 mm	PA	Ni TÜV ¹⁾	20



Assembly instructions MA564

www.staubli.com/electrical

¹⁾ These parts have been tested by TÜV Rheinland. Certificate no. R 60116228

POAG-HK.../KBT6-EC

Highly flexible connecting leads with green-yellow insulation for potential equal-

ization. One end with assembled right-angled, spring-loaded socket, other end open lead. Socket made of nickel-plated brass

with MULTILAM made of gold-plated, hard-drawn copper alloy. Various lead cross sections available.

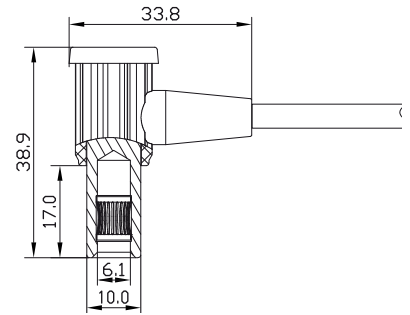
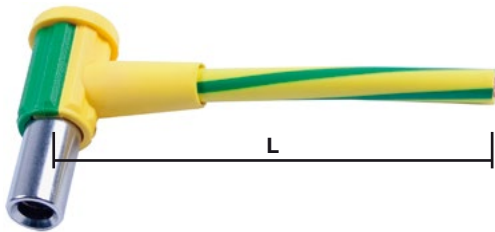

Order No.	Type	Lead cross section		Lead lengths L [cm]	Color	
55.3221-□□20	POAG-HK4/KBT6-EC	4.0 mm ²	max. Ø 5.9 mm	<div style="display: flex; align-items: center;"> <div style="border: 1px solid black; padding: 2px; margin-right: 2px;">Ni</div> <div style="border: 1px solid black; padding: 2px; margin-right: 2px;">PVC</div> <div style="font-weight: bold; font-size: 1.2em;">TÜV¹⁾</div> </div>	<div style="display: flex; gap: 5px;"> <div style="border: 1px solid black; padding: 2px;">100</div> <div style="border: 1px solid black; padding: 2px;">200</div> <div style="border: 1px solid black; padding: 2px;">300</div> <div style="border: 1px solid black; padding: 2px;">400</div> </div>	<div style="background-color: #90EE90; width: 15px; height: 10px; display: inline-block;"></div> 20
55.3226-□□20	POAG-HK6/KBT6-EC	6.0 mm ²			<div style="display: flex; align-items: center;"> <div style="border: 1px solid black; padding: 2px; margin-right: 2px;">Ni</div> <div style="border: 1px solid black; padding: 2px; margin-right: 2px;">PVC</div> <div style="font-weight: bold; font-size: 1.2em;">TÜV¹⁾</div> </div>	<div style="display: flex; gap: 5px;"> <div style="border: 1px solid black; padding: 2px;">100</div> <div style="border: 1px solid black; padding: 2px;">200</div> <div style="border: 1px solid black; padding: 2px;">300</div> <div style="border: 1px solid black; padding: 2px;">400</div> </div>

POAG-HK.../KBT6-EC/KBT6-EC

Highly flexible connecting leads with green-yellow insulation for potential equal-

ization. On both ends with assembled right-angled, spring-loaded socket. Sockets made of nickel-plated brass with MULTILAM

made of gold-plated, hard-drawn copper alloy. Various lead cross sections available.

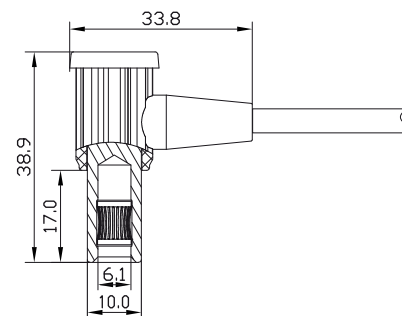
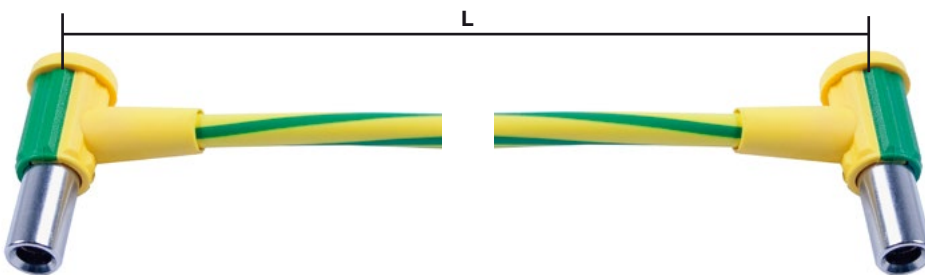

Order No.	Type	Lead cross section		Lead lengths L [cm]	Color	
55.3222-□□20	POAG-HK4/KBT6-EC/KBT6-EC	4.0 mm ²	max. Ø 5.9 mm	<div style="display: flex; align-items: center;"> <div style="border: 1px solid black; padding: 2px; margin-right: 2px;">Ni</div> <div style="border: 1px solid black; padding: 2px; margin-right: 2px;">PVC</div> <div style="font-weight: bold; font-size: 1.2em;">TÜV¹⁾</div> </div>	<div style="display: flex; gap: 5px;"> <div style="border: 1px solid black; padding: 2px;">100</div> <div style="border: 1px solid black; padding: 2px;">200</div> <div style="border: 1px solid black; padding: 2px;">300</div> <div style="border: 1px solid black; padding: 2px;">400</div> </div>	<div style="background-color: #90EE90; width: 15px; height: 10px; display: inline-block;"></div> 20
55.3227-□□20	POAG-HK6/KBT6-EC/KBT6-EC	6.0 mm ²			<div style="display: flex; align-items: center;"> <div style="border: 1px solid black; padding: 2px; margin-right: 2px;">Ni</div> <div style="border: 1px solid black; padding: 2px; margin-right: 2px;">PVC</div> <div style="font-weight: bold; font-size: 1.2em;">TÜV¹⁾</div> </div>	<div style="display: flex; gap: 5px;"> <div style="border: 1px solid black; padding: 2px;">100</div> <div style="border: 1px solid black; padding: 2px;">200</div> <div style="border: 1px solid black; padding: 2px;">300</div> <div style="border: 1px solid black; padding: 2px;">400</div> </div>

¹⁾ These parts have been tested by TÜV Rheinland. Certificate no. R 60116228

MC-POAG-EC/2 MC-POAG-EC6/2

Highly flexible connecting leads with green-yellow insulation for potential

equalization. On both ends with right-angled, spring-loaded sockets with extrusion-moulded insulation. Sockets made of

nickel-plated brass with MULTILAM made of gold-plated, hard-drawn copper alloy. Various lead cross sections available.

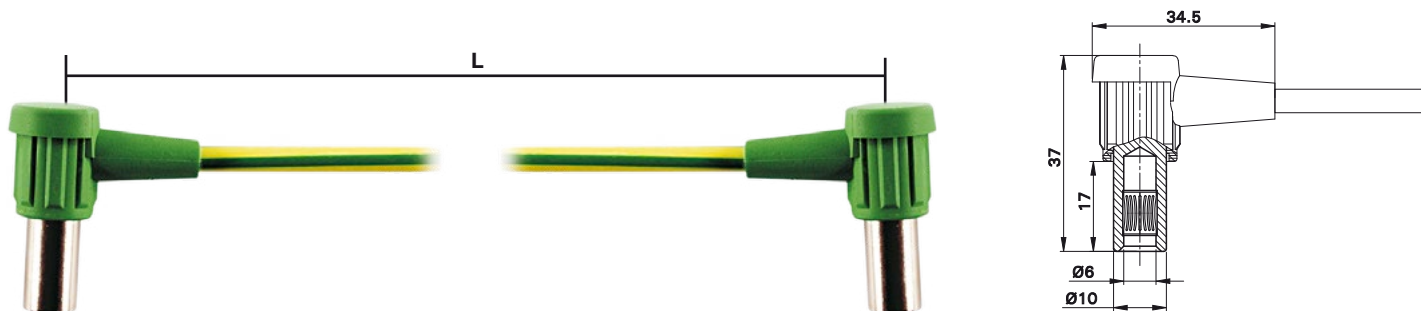

Order No.	Type	Lead cross section	Sleeve insulation		Lead lengths L [cm]	Color
55.3200-□	MC-POAG-EC/2	4.0 mm ²	TPE	Ni PVC TÜV ¹⁾	100 300	20
55.3210-□	MC-POAG-EC6/2	6.0 mm ²	TPE	Ni PVC TÜV ¹⁾	100 300	20

POAG-KBT6DIN

Right-angled socket for self-assembly of connecting leads for potential equalization.

Socket made of nickel-plated brass with MULTILAM made of gold-plated, hard-drawn copper alloy. **Crimp connection.**



Order No.	Type	Connectable conductor cross-section	Outer diameter	Insulation		Color
15.0010	POAG-KBT6DIN	4.0 mm ² / 6.0 mm ²	Ø 5.9 mm	TPE	Ni TÜV ¹⁾	24

Component parts

15.5004-24	T-POAG6	Insulator
01.0404	POAG-WB6DIN	Socket



Assembly instructions MA016

www.staubli.com/electrical

¹⁾ These parts have been tested by TÜV Rheinland. Certificate no. R 60116228

POAG-S6/...

Ø 6 mm plugs made of nickel-plated brass, to screw into instruments, beds or wall rails for potential equalization. Delivered in four standard lengths, other lengths on request.

The assembly material is not supplied!

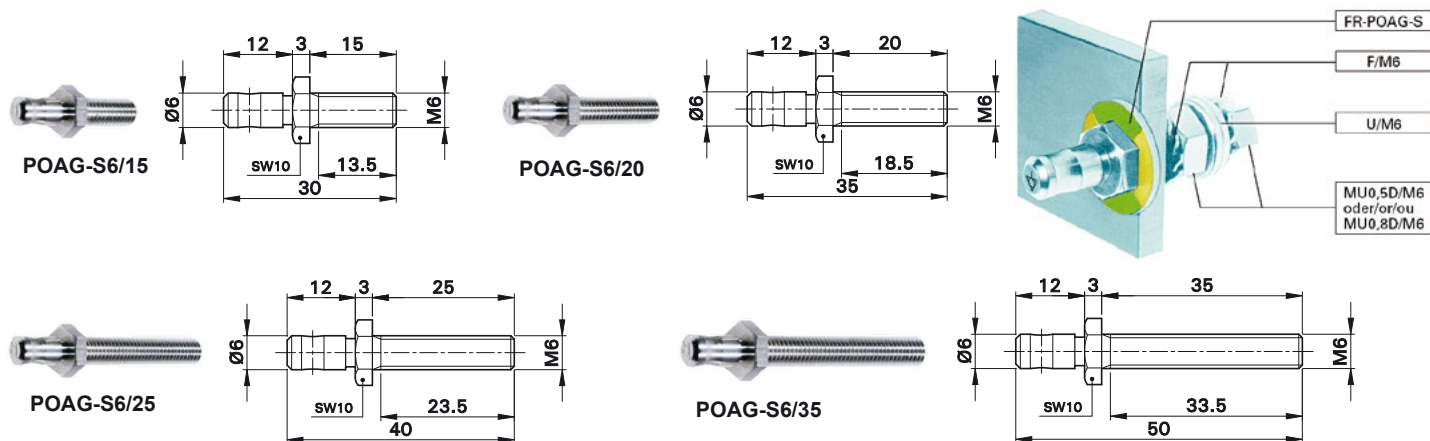

Order No.	Type	Tightening torque	
04.0056	POAG-S6/15	max. 3 Nm	Ni TÜV ¹⁾
04.0057	POAG-S6/20	max. 3 Nm	Ni TÜV ¹⁾
04.0058	POAG-S6/25	max. 3 Nm	Ni TÜV ¹⁾
04.0059	POAG-S6/35	max. 3 Nm	Ni TÜV ¹⁾

Assembly material

14.5010	FR-POAG-S	Color code washer
08.0704	F/M6	Serrated lock washer (DIN 6798)
08.0501	MU0,5D/M6	Nut (DIN 439)
08.0502	MU0,8D/M6	Nut (DIN 934)
08.0601	U/M6	Washer (DIN 125)

¹⁾ These parts have been tested by TÜV Rheinland. Certificate no. R 60116228

POAG-ID6

A black colored panel terminal with a green-yellow colored ring and a built-in

plug POAG-S6/25, nickel-plated according to DIN standard. Suitable for mounting in flushtype boxes.

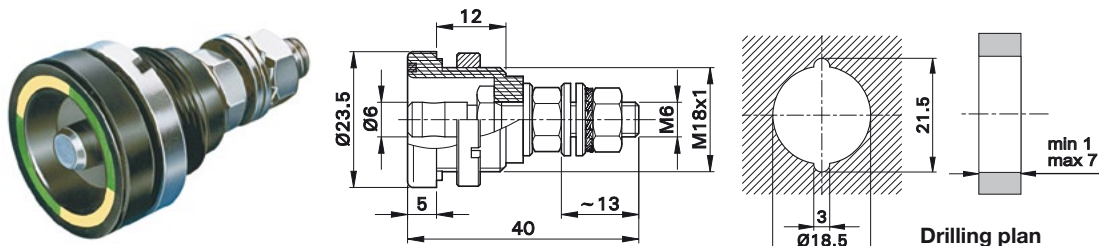

Assembly instructions MA045

www.staubli.com/electrical

Order No.	Type	Insulation		Color
14.0007	POAG-ID6	POM	Ni TÜV ¹⁾	20

Supplied component parts

14.5007	IS-POAG	Insulation housing
14.5005	MUID/M18x1	Ring nut, nickel-plated
08.0502	MU0,8D/M6	2 nuts (DIN 934)
08.0601	U/M6	3 washers
08.0704	FM/6	Serrated lock washer (DIN 6798)
14.5004-20	FR6	Color code washer

Accessories

14.5008	SS6	Socket spanner
---------	-----	----------------

MC-POAG-K6FS/VMB3/KBT6DIN/100

Highly flexible green-yellow extension lead with triple socket for potential equalization.

Fitted at one end with right-angled female plug with spring-loaded MULTILAM (type POAG-KBT6DIN), other end 3 terminals

POAG-ID6. Contact parts in nickel-plated brass, MULTILAM of socket in gold-plated hard copper alloy.

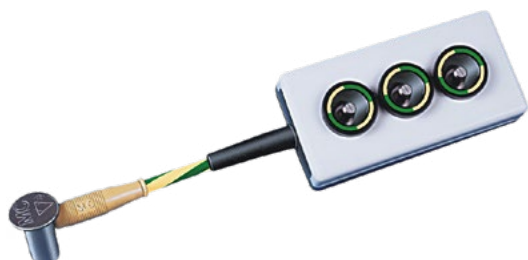

Order No.	Type	Lead cross section		Lead lengths L [cm]	Color
15.2017-100	MC-POAG-K6FS/VMB3/KBT6DIN/100	6.0 mm ²	Ni PVC TÜV ¹⁾	100	20

¹⁾ These parts have been tested by TÜV Rheinland. Certificate no. R 60116228

Multistrand wires for medical applications

FLEXI-S/POAG-HK...

Highly flexible, reinforced PVC insulated stranded wire. Green-yellow insulation with

helical green stripe. Super-fine strand, bright-soft, tightly twisted.

Typical Application: Potential equalization, e.g. in the medical engineering field.

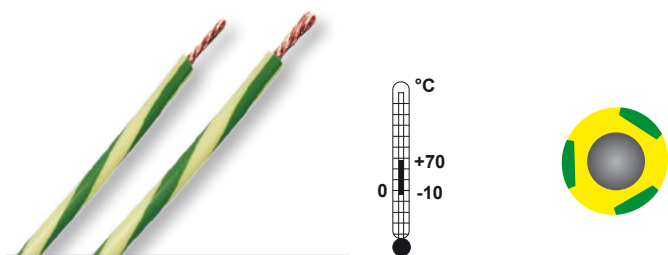

Order No.	Type	Nominal cross section	Strand design	Weight of cable	Conductor diameter	Thickness insulation wall	Outer diameter	Rated voltage	Test voltage	Rated current	* Colors
	PVC	mm ²	n × Ø mm	kg/km	mm	mm	mm	V	VAC	A	
15.2010-□20	FLEXI-S/POAG-HK4	4.0	1036 × 0.07	52	3.0	0.90	4.8	600	2500	42	20 ¹⁾
15.2015-□20	FLEXI-S/POAG-HK6	6.0	1548 × 0.07	80	3.8	1.05	5.9	600	2500	54	20 ¹⁾

If you are interested in our full range of “Cables and multistrand wires”, please ask for a copy of our main catalog!

¹⁾ Yellow with three helical green stripes, each 2 mm wide with 4-5 windings per meter.

Tools

MB2-S SS2-S SS2-M SS4

Steel assembly mandrel and pipe spanner
for press-fit and screw-mounting terminals
MEB... and MLB...

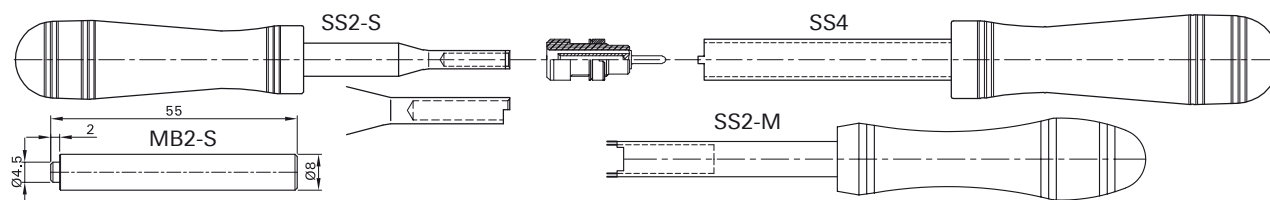

Order No.	Type	Designation	Suitable for terminal types
25.0028	MB2-S	Assembly mandrel	MEB1,5-R
25.0023	SS2-S	Tube spanner	MLB1,5-R
25.0026	SS2-M	Tube spanner	MLB2,0-R, MLB2,0-R
25.0021	SS4	Tube spanner	MLB1,5-R, MLB2,0-R, MLB2,0-R

Socket Spanner



Order No.	Type
14.5008	SS6

Crimping pliers



Order No.	Type
14.5009	POAG-PZ-N

Index

Type	Page
FLEXI-S/POAG-HK4	21
FLEXI-S/POAG-HK6	21
F/M6	19
FM/6	20
FR6	20
FR-POAG-S	19
IS-POAG	20
MB2-S	22
MC-POAG-EC/2	18
MC-POAG-EC6/2	18
MC-POAG-K6FS/VMB3/KBT6DIN/100	20
MEB1,5-R	9
MEB2,0-L	11
MEB2,0-R	11
MLA2	13
MLA2-S	13
MLB1,5-R	9
MLB2,0-L	12
MLB2,0-R	12
MLK2,0-LS/P	14
MS155-B	8
MS205-S	10
MS255-B	10
MS1525-B	8
MS1525-S	8
MS2025-S	10

Type	Page
MU0,5D/M6	19
MU0,8D/M6	19, 20
MUID/M18x1	20
POAG-HK4/KBT6-EC	17
POAG-HK4/KBT6-EC/KBT6-EC	17
POAG-HK6/KBT6-EC	17
POAG-HK6/KBT6-EC/KBT6-EC	17
POAG-ID6	20
POAG-KBT6DIN	18
POAG-KBT6-EC/4	16
POAG-KBT6-EC/6	16
POAG-PZ-N	22
POAG-S6/15	19
POAG-S6/20	19
POAG-S6/25	19
POAG-S6/35	19
POAG-WB6DIN	18
SS2-M	22
SS2-S	22
SS4	22
SS6	22
T-POAG6	18
U/M6	19, 20



■ Stäubli Units ○ Agents

Global presence of the Stäubli Group

www.staubli.com

X-ON Electronics

Largest Supplier of Electrical and Electronic Components

Click to view similar products for [Test Leads](#) category:

Click to view products by [STAUBLI](#) manufacturer:

Other Similar products are found below :

[795-2384-10-25](#) [1301430020](#) [1510-24-105](#) [BU-1149-A-36-0](#) [BU-1481-E-12-0](#) [BU-1481-E-24-0](#) [1927617](#) [2450](#) [2524-A-60](#) [LB1F-2R-RED](#)
[LB1F-2R-YLW](#) [2524-A-48](#) [2977-J-48](#) [380200](#) [BU-1449-E-12-2](#) [BU-1480-E-24-0](#) [BU-1481-E-12-2](#) [BU-1481-E-24-2](#) [LB1F-2R-BLK](#) [LB1F-](#)
[2R-BLUE](#) [LB1F-2R-WHT](#) [6345](#) [6432](#) [6416](#) [EM3782-24-3#](#) [R948161002](#) [R948160002](#) [R948170002](#) [R948171002](#) [R948163002](#) [973604100](#)
[934160101](#) [934160100](#) [R948174000](#) [CT3269](#) [CT3258](#) [CT3158-100](#) [HSPL 8568/AWG16/200/RT](#) [HSPL 8568/AWG16/200/SW](#) [28.0119-](#)
[10020](#) [49.0079-20024](#) [28.0126-05020](#) [66.9407-05028](#) [66.9407-20027](#) [MT5-LEADS](#) [TL1550EXT](#) [1510-24-102](#) [924963](#) [EM3782-36-3#](#)
[EM3782-36-8#](#)