

LK425K-41/A

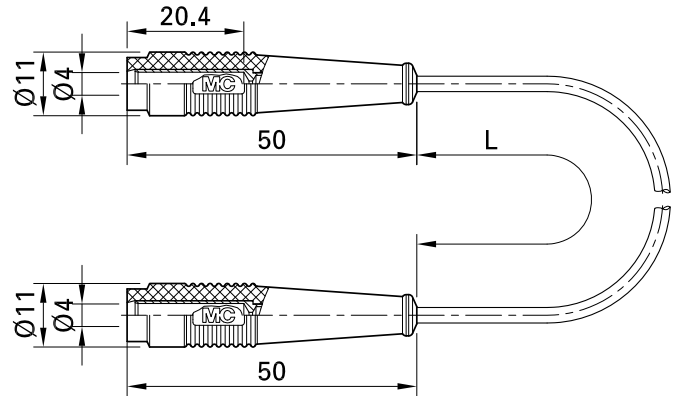

Item number 64.1024-*

Highly flexible, with Ø 4 mm rigid sockets on both ends.

Technical data	
Diameter of plug system	4 mm
Rated Values	30 V, 32 A / 60 V, 32 A
Surface treatment electrical contact	Au
Base material electrical contact	CuZn
Standard color(s) *	21 22
Optional color(s)	23 24 25 27 28 29
Lead lengths <input type="text"/>	100 cm
Lead insulation	PVC
Lead cross section	2,5 mm ²
Test accessory acc. to	IEC EN 61010-031
User-Information	I 099

X-ON Electronics

Largest Supplier of Electrical and Electronic Components

Click to view similar products for [Test Leads](#) category:

Click to view products by [STAUBLI](#) manufacturer:

Other Similar products are found below :

[614187](#) [668571](#) [795-2384-10-25](#) [855705](#) [1301430020](#) [1510-24-105](#) [BU-1149-A-36-0](#) [BU-1481-E-12-0](#) [BU-1481-E-24-0](#) [1888177](#) [1888358](#)
[1894586](#) [1894676](#) [1894810](#) [1895013](#) [1895051](#) [1895097](#) [1895114](#) [1895138](#) [1895177](#) [1895263](#) [1895288](#) [1895320](#) [1895484](#) [1895504](#)
[1895528](#) [1895596](#) [1895632](#) [1895644](#) [1908984](#) [1909524](#) [1911623](#) [1919532](#) [1922532](#) [1922571](#) [1923162](#) [1923196](#) [1927617](#) [2450](#) [2524-A-60](#)
[2530650](#) [911433](#) [LB1F-2R-RED](#) [LB1F-2R-YLW](#) [3045646](#) [1632463](#) [1888570](#) [1888581](#) [1894455](#) [1894629](#)