

# Test accessories HF Main catalog

HFlite | Test & Measurement

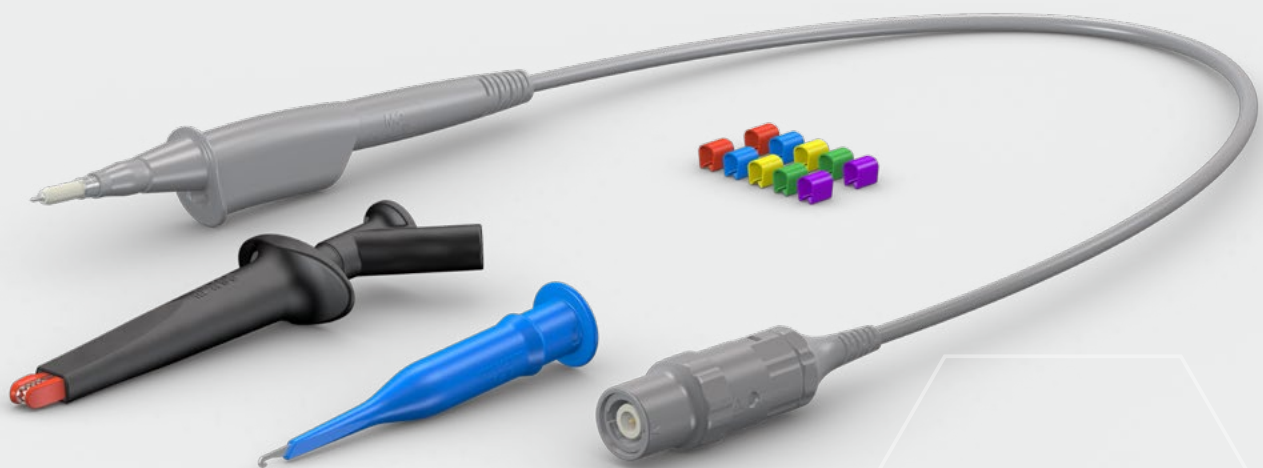

## STÄUBLI ELECTRICAL CONNECTORS

## Long-term solutions – Expert connections



**Stäubli Electrical Connectors is a leading international manufacturer of high-quality electrical connector systems. We are part of the Stäubli Group which offers mechatronics solutions for electrical connectors, liquid and gas couplings, robots and textile machinery.**

Stäubli develops, produces, sells and maintains products for markets with high productivity standards. As recognized specialists, our focus is always on solutions and customers. Many new developments got their start here and have begun to make their way around the world.

Businesses and customers count on our commitment and our active support when dealing with unusual problems. With us, you are entering into a long-term partnership built on reliability, dynamism, and exceptional quality in both products and services.

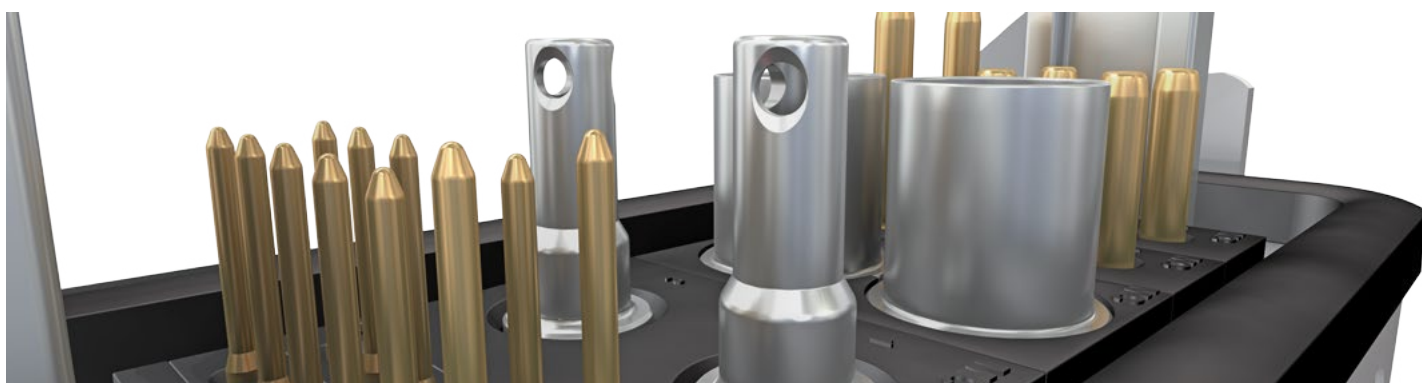

# Applications and advantages



**This product range includes passive high-frequency test probes (HF probes) and accessories as well as touch-protected BNC plug connectors, leads, adapters and converters.**

Our test probes are suitable for use in CAT III- and CAT IV environments (Measurement Categories), such as the analysis of house and building installations with mains analysis/mains monitoring devices. The use of a coaxial connecting cable with a particularly

low capacitance, together with modifications in the interior of the probe, results in a further improvement in the electrical characteristics (e.g. a lower input capacity) compared with the tried and tested Isoprobe II generation of probes.

# Contents

<b>Page 5</b>	<b>Ordering Information</b>	<b>Page 41</b>	<b>BNC Safety Test Leads</b>
<b>Page 6</b>	<b>Isoprobe IV</b> <ul style="list-style-type: none"><li>■ Probe</li><li>■ Probe Set</li><li>■ Accessories</li></ul>	<b>Page 45</b>	<b>Touch-protected BNC Connectors and BNC Panel-mount Sockets</b>
<b>Page 12</b>	<b>Isoprobe II</b> <ul style="list-style-type: none"><li>■ Probe</li><li>■ Probe Set</li></ul>	<b>Page 51</b>	<b>BNC / Ø 4 mm Adapters and Adapter Leads</b>
<b>Page 24</b>	<b>Isoprobe III</b> <ul style="list-style-type: none"><li>■ Probe</li><li>■ Probe Set</li></ul>	<b>Page 56</b>	<b>BNC / Ø 2 mm Adapters and Adapter Leads</b>
<b>Page 34</b>	<b>Isoprobe III-HP</b> <ul style="list-style-type: none"><li>■ Probe</li><li>■ Probe Set</li><li>■ Accessories Isoprobe II and Isoprobe III</li></ul>	<b>Page 57</b>	<b>BNC Lead Couplers</b>
		<b>Page 58</b>	<b>BNC Signal Distributors</b>
		<b>Page 59</b>	<b>Touch-protected Adapters and Converters</b>
		<b>Page 65</b>	<b>Technical Information</b>
		<b>Page 70</b>	<b>Index</b>

# Ordering Information

## Technical modifications and information given in the catalogue

**We have a policy of continuous improvement and reserve the right to make technical modifications to any product in accordance with any safety and technical developments. We accept no responsibility for the accuracy of the information given in the catalogue.**

### Order code

When ordering, always state the order number of the article in addition to the type designation. For articles that are available in more than one colour or lead length, write the desired lengths and colour codes after the order number instead of the spaces  and \* used in the catalogue.

**Example:** The catalogue offers the following:

BNC Safety Test Lead XLSS-58,

Order No. 67.9770-\*,

Lengths: 050 100 150 200 cm,

Colours: 21 22 23

For a lead with a length of 150 cm in red, your order should read as follows:

BNC Safety Test Lead XLSS-58, 150 cm, red, Order No. 67.9770-15022

### Lead length

The lead length of all standard leads in this catalogue refers to the visible length of the cable.

### Colour Variations

Due to the use of high-grade types of insulating materials, despite having the same colour code some of our articles may exhibit certain differences in colour (e.g. a silicone-insulated lead fitted with TPE-insulated plugs).

### Delivery Time

Many products are available ex-stock. Additional assembly time may be required for those items not ex-stock. Delivery times are available on request.

### Small Orders

We request that small value orders are placed with one of our distributors.

### Standard and Special Designs

This catalogue details those assembled leads which are most commonly requested. We can of course manufacture to specific requests and are happy to quote for special designs. In addition, please contact us with regards to any special requirements such as alternative surface treatments.

### Copyright

The use of this catalogue for any other purpose, in whatever form, without our prior written consent is not permitted.

### RoHS ready

EU directive 2011/65/EC restricts the use of certain hazardous substances in electrical and electronic equipment (RoHS conformity). Although this directive is not yet applicable to electrical test accessories, for all articles presented in this catalogue we use only materials that would conform to the RoHS criteria.

### Colour code

<input type="text"/> 20	green-yellow	<input type="text"/> 26	violet
<input type="text"/> 21	black	<input type="text"/> 27	brown
<input type="text"/> 22	red	<input type="text"/> 28	grey
<input type="text"/> 23	blue	<input type="text"/> 29	white
<input type="text"/> 24	yellow	<input type="text"/> 33	transparent
<input type="text"/> 25	green		

### Surface treatment

<input type="text"/> Ag	silver-plated
<input type="text"/> Au	gold-plated
<input type="text"/> Ni	nickel-plated
<input type="text"/> Opt	Optalloy®-finish

### Lead insulation

<input type="text"/> PVC	PVC
<input type="text"/> TPE	TPE
<input type="text"/> SIL	SIL

### Lead insulation

<input type="text"/> CE	CE conform
<input type="text"/> UL LISTED	UL approval
<input type="text"/> UL	UL approval

# Isoprobe IV

## Oscilloscope probes in compact design

The new Isoprobe IV generation of passive probes is a highly compact addition to the Stäubli range of touch-protected high-frequency probes. The greatly reduced size of this new product substantially facilitates the conduct of measurements in a restricted space, while still retaining the good electron-

ic characteristics of Stäubli Isoprobe test probes. Despite their compact construction and correspondingly smaller clearances and creepage distances, the Isoprobe IV probes have a high touch protection rating of CAT III at 300 V. The Isoprobe IV generation is particularly suited for electronics engineers,

while the probes of the Isoprobe II and Isoprobe III series are designed primarily for electricians. The Isoprobe IV models are available as 10:1 and 100:1-divider probes.

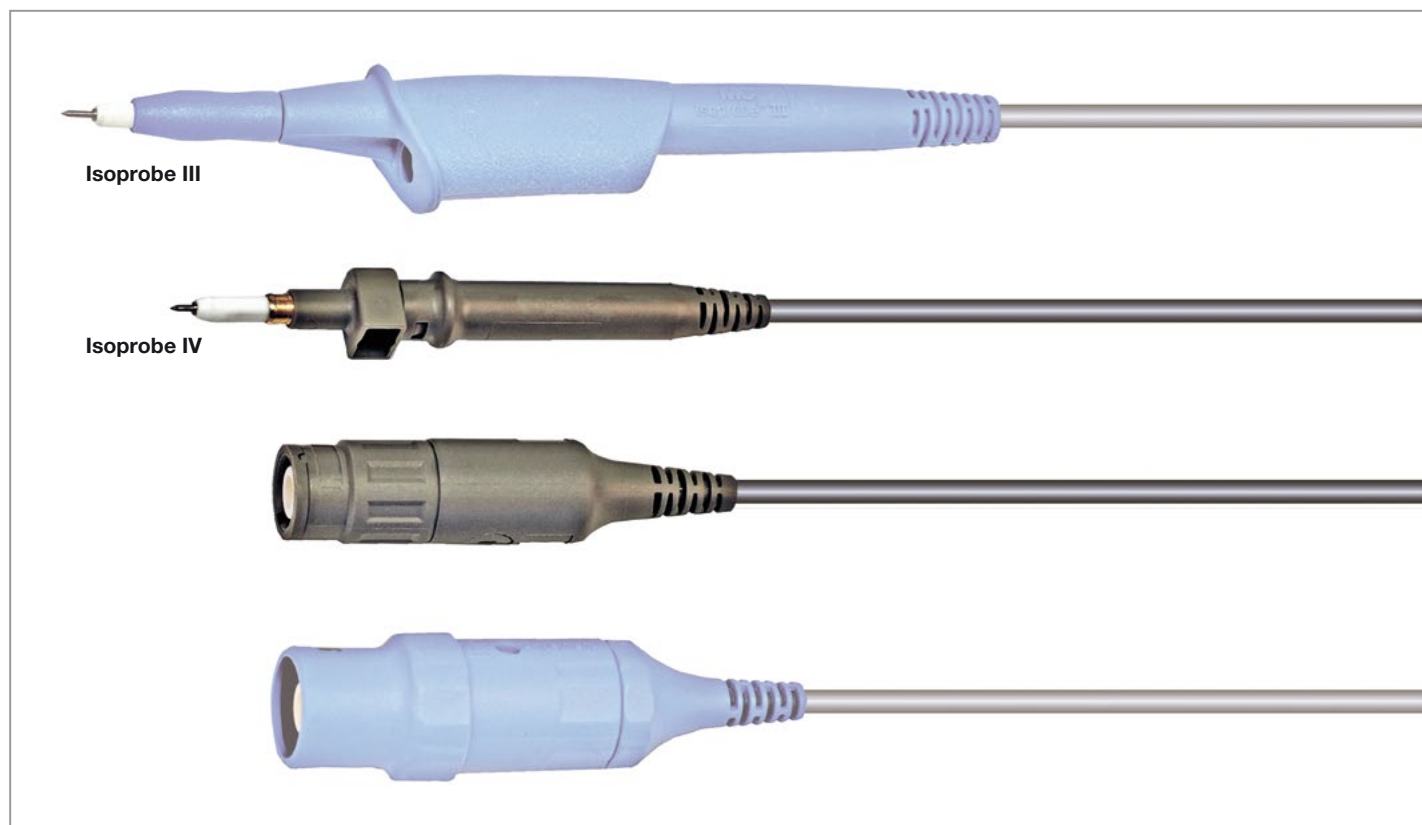

**For comparison:**

Compact Isoprobe IV beside a probe of the existing Isoprobe III series.

Isoprobe IV are available singly or in a set with accessories specially adapted to the new probes.



**Contents of the Sets:**

- 1. Oscilloscope probe Isoprobe IV- 10:1 or Isoprobe IV- 100:1
- 2. Push-on hook clip HC400
- 3. Push-on BNC adapter BA400

- 4. Push-on reference contact GS400
- 5. Reference lead with crocodile clip GM400
- 6. Set of colour clips SCC
- 7. Protective cap

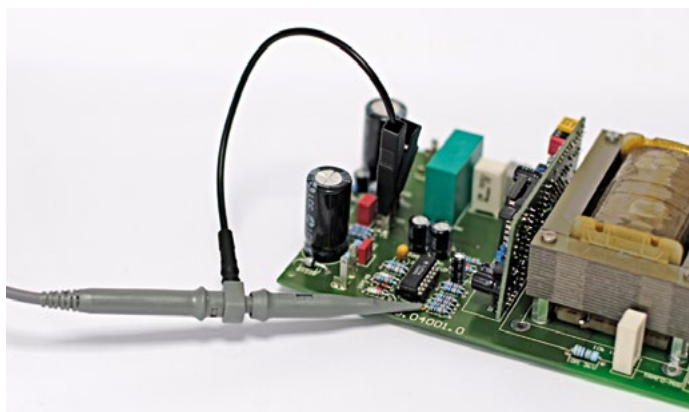

# Oscilloscope probes in compact design

## Isoprobe IV – 10:1

Safety high-frequency 10:1 test probe of compact design. With wide frequency range combined with low input capacitance. Highly flexible PVC-insulated coaxial connecting

lead with BNC plug with integrated compensation unit. Facility for connecting reference lead in the front part of the probe.

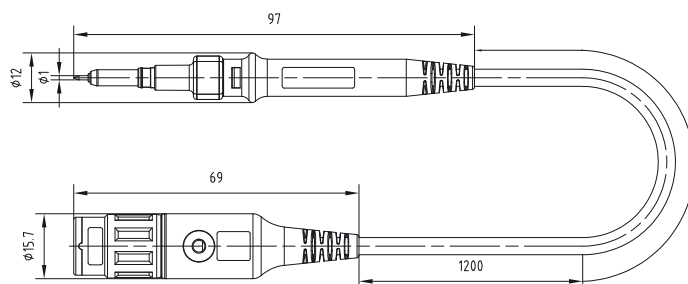

Order No.	Type		Lead length [cm]	Colour
68.9366-12028	Isoprobe IV - 10:1	PVC CE	120	28

Technical Data		
	Shield / earth	Probe tip / shield
Rated voltage (frequency-dependent)	Max. 300 V, CAT III	Max. 300 V <sub>r.m.s</sub>
Dividing ratio	10:1	
Input capacitance	11 pF	
Compensation range (works setting)	10 pF ... 25 pF (15 pF)	
Input resistance	10 MΩ	
Frequency range	0 ... 500 MHz	
Rise time	0.9 ns	
Lead length	120 cm	



RZ Sheet RZ103

[www.staubli.com/electrical](http://www.staubli.com/electrical)



## Isoprobe IV – 100:1

Safety high-frequency 100:1 test prob of compact design. As a result of its low input capacitance and high input resistance, the

probe is ideally suited for measurements on sensitive circuits. Highly flexible PVC-insulated coaxial connecting lead with BNC

plug with integrated compensation unit. Facility for connecting reference lead in the front part of the probe.

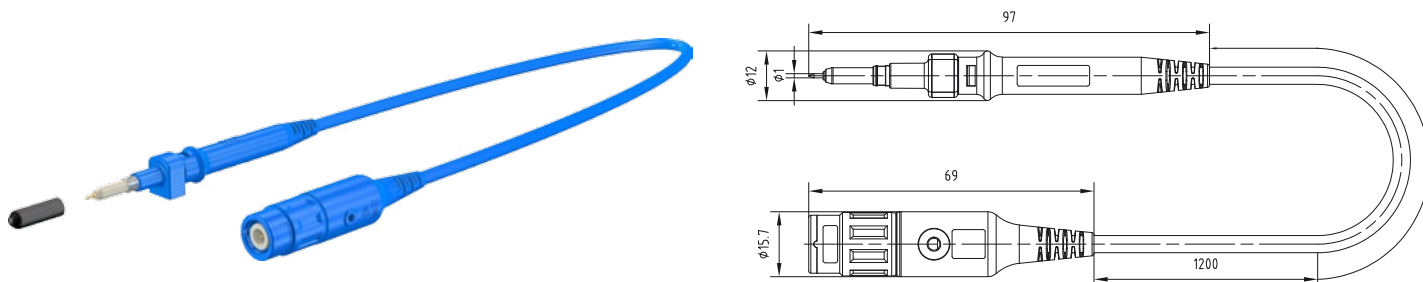

Order No.	Type		Lead length [cm]	Colour
68.9367-12023	Isoprobe IV – 100:1	PVC CE	120	23

Technical Data		
	Shield / earth	Probe tip / shield
Rated voltage (frequency-dependent)	Max. 300 V, CAT III	Max. 300 V <sub>r.m.s</sub>
Dividing ratio	100:1	
Input capacitance	4.6 pF	
Compensation range (works setting)	10 pF ... 25 pF (15 pF)	
Input resistance	100 MΩ	
Frequency range	0 ... 500 MHz	
Rise time	0.9 ns	
Lead length	120 cm	



RZ Sheet RZ104

[www.staubli.com/electrical](http://www.staubli.com/electrical)

## SET Isoprobe IV – 10:1 SET Isoprobe IV – 100:1

The sets Isoprobe IV - 10:1 / 100:1 contain accessories to meet the needs of a professionally equipped electronics technician.



Order No.	Type	Rated voltage		Colour
68.9433-28	SET Isoprobe IV – 10:1	Max. 300 V, CAT III	CE ⚠ RZ 103	28
68.9434-23	SET Isoprobe IV – 100:1	Max. 300 V, CAT III	CE ⚠ RZ 104	23

### Supplied components

Isoprobe IV – 10:1/100:1 Page 8/9			
HC400 Page 11		GM400 Page 11	
GS400 Page 11		BA400 Page 11	
SCC Page 40			



RZ Sheet RZ103, RZ104

[www.staubli.com/electrical](http://www.staubli.com/electrical)

# Isoprobe IV – Accessories

## HC400

Push-on hook clip.

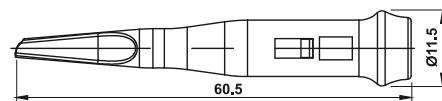

Order No.	Type	Rated voltage		*Colours
68.9369-*	HC400	600 V, CAT II (300 V, CAT III)	CE	23 28

## GS400

Push-on reference contact.

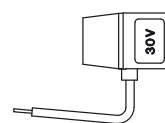

Order No.	Type	Rated voltage		Colour
68.9443-21	GS400	30 V <sub>AC</sub> /60 V <sub>DC</sub>	CE cUL <sub>US</sub> LISTED	21

## GM400

Highly flexible reference lead with insulation in silicone. One end with fork-type plug for connecting to the shielded contact on the

side of the probe, other end with crocodile clip with allround insulation and toothed gripping jaws with fine-wire clamping surface.

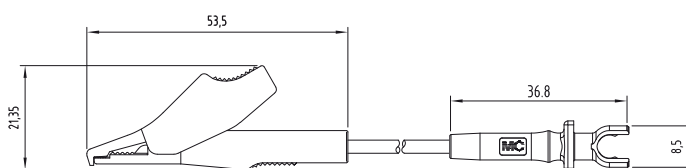

Order No.	Type	Rated voltage	Lead cross section		Lead length [cm]	Colour
68.9444-01521	GM400	600 V, CAT II (300 V, CAT III)	0.50 mm <sup>2</sup>	SIL CE	015	21

## BA400

Uninsulated push-on BNC adapter.

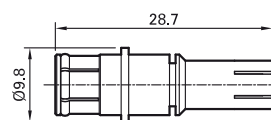

Order No.	Type
68.9376	BA400

# Touch-protected Passive Oscilloscope Probes Isoprobe II and Probe Sets

## Isoprobe II – 1:1

Safety high-frequency test probe with highly flexible PVC-insulated coaxial connecting lead with BNC plug. Ø 2 mm safety socket for reference lead connection in the handling part.

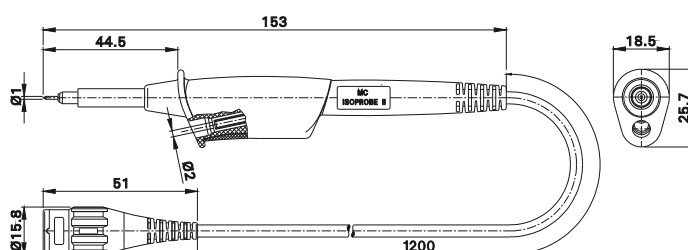

Order No.	Type		Lead length [cm]	Colour
68.9870-12021	Isoprobe II – 1:1	PVC CE cUL LISTED	120	21

Technical Data		
Rated voltage (frequency-dependent)	Max. 300 V, CAT III	
Dividing ratio	1:1	
Input capacitance	Input capacitance of measuring instrument + 42 pF	
Input resistance	Input resistance of measuring instrument	
Frequency range	0 ... 45 MHz	
Rise time	Rise time of measuring instrument + 6 ns	
Lead length	120 cm	



RZ Sheet RZ041

[www.staubli.com/electrical](http://www.staubli.com/electrical)



## SET Isoprobe II – 1:1

Test probe set, consisting of safety high-frequency test probe Isoprobe II - 1:1 and accessories.

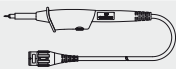

Order No.	Type	Rated voltage		Colour
68.9490-21	SET Isoprobe II - 1:1	Max. 300 V, CAT III	CE 	21

### Supplied components

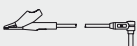
Isoprobe II – 1:1 Page 12	
HC200 Page 37	
GM200 Page 40	

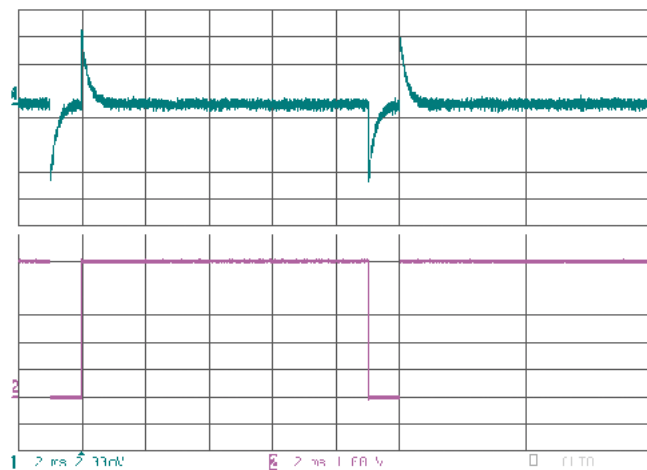

RZ Sheet RZ041

[www.staubli.com/electrical](http://www.staubli.com/electrical)

## Isoprobe II – 10:1 ECO

Safety high-frequency 10:1 test probe highly flexible PVC-insulated coaxial connecting lead with BNC plug. Compensation adjust-

ment screw and Ø 2 mm safety socket for reference lead connection in the handling part. Economically priced model.

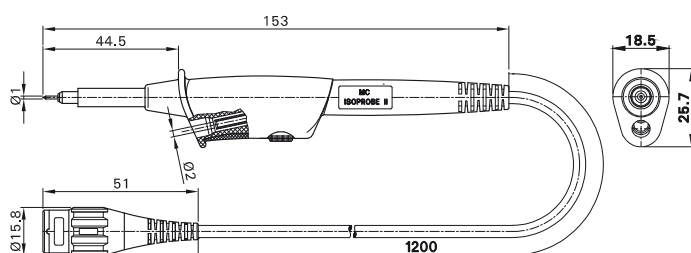

Order No.	Type		Lead length [cm]	Colour
68.9880-12028	Isoprobe II – 10:1 ECO	PVC CE cUL <sub>us</sub> LISTED	120	28

Technical Data		
Rated voltage (frequency-dependent)	Max. 600 V, CAT II (300 V, CAT III)	
Dividing ratio	10:1	
Input capacitance	13 pF	
Compensation range (works setting)	10 pF ... 30 pF (15 pF)	
Input resistance	10 MΩ	
Frequency range	0 ... 500 MHz	
Rise time	1 ns	
Lead length	120 cm	



RZ Sheet RZ048



[www.staubli.com/electrical](http://www.staubli.com/electrical)

## SET Isoprobe II – 10:1 ECO



The basic set Isoprobe II - 10:1 ECO includes a basic set of accessories for effect-

ing safe and accurate high-frequency measurements. Good value for money.

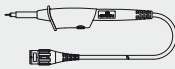

Order No.	Type	Rated voltage		Colour
68.9491-28	SET Isoprobe II – 10:1 ECO	Max. 600 V, CAT II (300 V, CAT III)	 	28

### Supplied components

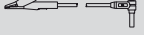
Isoprobe II – 10:1 ECO Page 14	
HC200 Page 37	
GS400 Page 38	
GM200 Page 40	

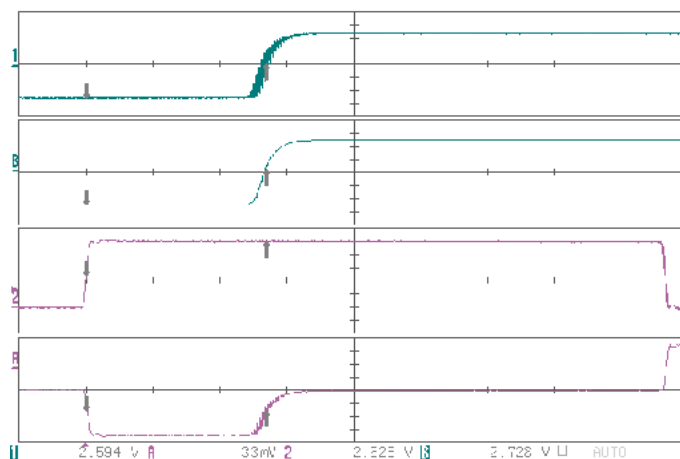

RZ Sheet RZ048

[www.staubli.com/electrical](http://www.staubli.com/electrical)

## Isoprobe II – 10:1 HF

Safety high-frequency 10:1 test probe highly flexible PVC-insulated coaxial connecting lead with BNC plug. Compensation adjustment screw and Ø 2 mm safety socket for

reference lead connection in the handling part. Wide frequency range combined with high dielectric strength.

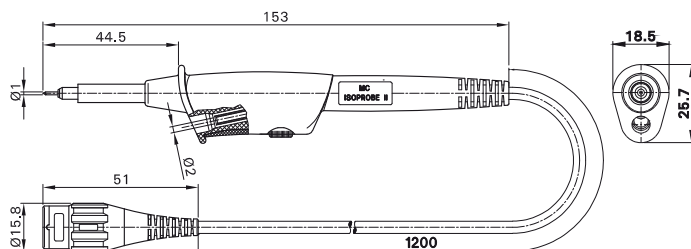

Order No.	Type		Lead length [cm]	Colour
68.9872-12022	Isoprobe II – 10:1 HF	PVC CE cUL LISTED	120	22

### Technical Data

Rated voltage (frequency-dependent)	Max. 1000 V, CAT II (600 V, CAT III)
Dividing ratio	10:1
Input capacitance	14 pF
Compensation range (works setting)	12 pF ... 22 pF (15 pF)
Input resistance	10 MΩ
Frequency range	0 ... 450 MHz
Rise time	1 ns
Lead length	120 cm

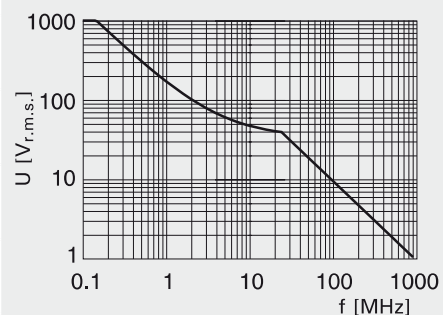

RZ Sheet RZ042

[www.staubli.com/electrical](http://www.staubli.com/electrical)





## SET Isoprobe II – 10:1 HF

Test probe set with extensive range of accessories for the needs of the professionally equipped test engineer.

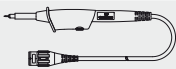

Order No.	Type	Rated voltage		Colour
68.9492-22	SET Isoprobe II – 10:1 HF	Max. 1000 V, CAT II (600 V, CAT III)	CE 	22

### Supplied components

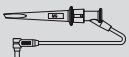
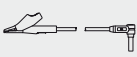
Isoprobe II – 10:1 HF Page 16	
HC200 Page 37	
GS400 Page 38	
GH200 Page 39	
GM200 Page 40	

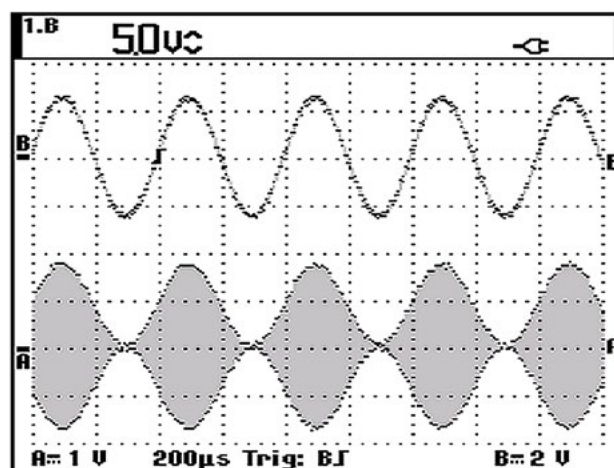

RZ Sheet RZ042

[www.staubli.com/electrical](http://www.staubli.com/electrical)

## Isoprobe II – 10:1 HS

Safety high-frequency 10:1 test probe highly flexible PVC-insulated coaxial connecting lead with BNC plug. Compensation adjust-

ment screw and Ø 2 mm safety socket for reference lead connection in the handling part.

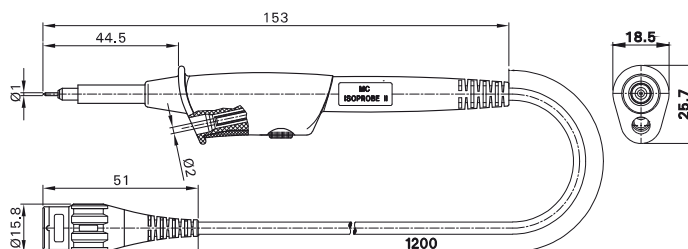

Order No.	Type		Lead length [cm]	Colour
68.9871-12028	Isoprobe II – 10:1 HS	PVC CE UL LISTED	120	28

### Technical Data

Rated voltage (frequency-dependent)	Max. 1000 V, CAT II (600 V, CAT III)
Dividing ratio	10:1
Input capacitance	16 pF
Compensation range (works setting)	10 pF ... 35 pF (25 pF)
Input resistance	10 MΩ
Frequency range	0 ... 250 MHz
Rise time	1.2 ns
Lead length	120 cm

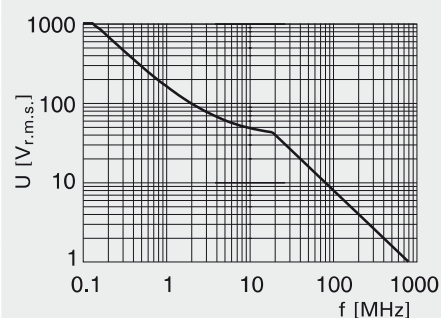

RZ Sheet RZ062

[www.staubli.com/electrical](http://www.staubli.com/electrical)

## SET Isoprobe II – 10:1 HS

Test probe set with an extensive range of accessories, suitable for users like electric power engineers who carry out measurements directly on the mains.



Order No.	Type	Rated voltage		Colour
68.9493-28	SET Isoprobe II – 10:1 HS	Max. 1000 V, CAT II (600 V, CAT III)	CE cULus LISTED	28

### Supplied components

Isoprobe II – 10:1 HS Page 18	
HC200 Page 37	
AC200 Page 37	
GM200 Page 40	
AB200 Page 39	
GB200 Page 40	

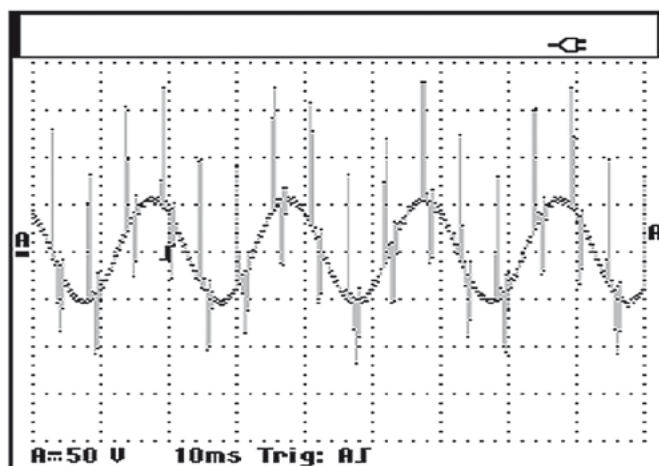

RZ Sheet RZ062

[www.staubli.com/electrical](http://www.staubli.com/electrical)

## Isoprobe II – 10:1 – 2,5

Safety high-frequency 10:1 test probe with a long, highly flexible PVC-insulated coaxial connecting lead with BNC plug, specially suited for bridging long distances between the test instrument and the object under

test. Compensation adjustment screw and Ø 2 mm safety socket for reference lead connection in the handling part.

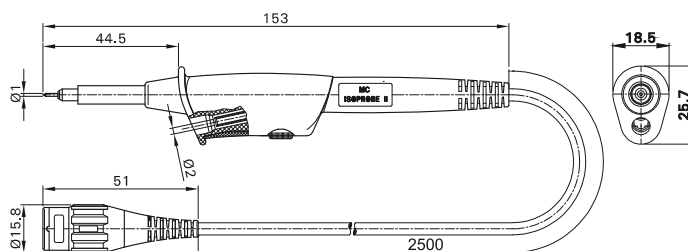

Order No.	Type		Lead length [cm]	Colour
68.9495-25022	Isoprobe II – 10:1 – 2,5	PVC CE cUL LISTED	250	22

Technical Data		
Rated voltage (frequency-dependent)	Max. 1000 V, CAT II (600 V, CAT III)	
Dividing ratio	10:1	
Input capacitance	18 pF	
Compensation range (works setting)	10 pF ... 30 pF (15 pF)	
Input resistance	10 MΩ	
Frequency range	0 ... 150 MHz	
Rise time	1.3 ns	
Lead length	250 cm	



RZ Sheet RZ052

[www.staubli.com/electrical](http://www.staubli.com/electrical)

## SET Isoprobe II – 10:1 – 2,5

Test probe set, consisting of safety high-frequency test probe Isoprobe II - 10:1 - 2,5 and accessories. The test probe with long

connecting lead is specially suited for bridging long distances between the test instrument and the object under test.



Order No.	Type	Rated voltage		Colour
68.9496-22	SET Isoprobe II – 10:1 – 2,5	Max. 1000 V, CAT II (600 V, CAT III)	CE 	22

### Supplied components

Isoprobe II – 10:1 – 2,5 Page 20	
HC200 Page 37	
GM200 Page 40	



RZ Sheet RZ052

[www.staubli.com/electrical](http://www.staubli.com/electrical)

## Isoprobe II – 100:1

Safety high-frequency 100:1 test probe for safe measurements at high voltages. With highly flexible PVC-insulated coaxial connecting lead with BNC plug. Compensation

adjustment screw and Ø 2 mm safety socket for reference lead connection in the handling part. As a result of its low input capacitance and high input impedance, the probe is ide-

ally suited for measurements on sensitive circuits.

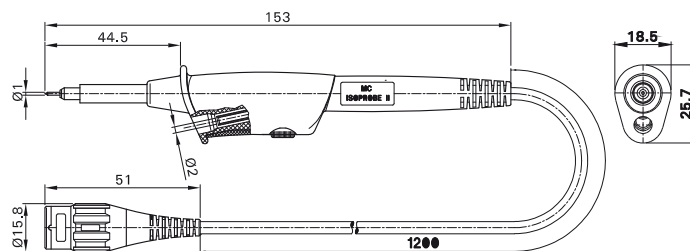

Order No.	Type		Lead length [cm]	Colour
68.9873-12023	Isoprobe II – 100:1	PVC CE UL LISTED	120	23

Technical Data	
Rated voltage (frequency-dependent)	Max. 1000 V, CAT II (600 V, CAT III) (Max. 3540 V, CAT I)
Dividing ratio	100:1
Input capacitance	6.5 pF
Compensation range (works setting)	10 pF ... 25 pF (15 pF)
Input resistance	100 MΩ
Frequency range	0 ... 300 MHz
Rise time	1 ns
Lead length	120 cm



RZ Sheet RZ043



[www.staubli.com/electrical](http://www.staubli.com/electrical)

## SET Isoprobe II – 100:1





Test probe set for safe measurements at high voltages. As a result of its low input capacitance and high input impedance, the

probe is ideally suited for measurements on sensitive circuits.

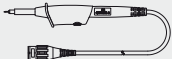

Order No.	Type	Rated voltage		Colour
68.9494-23	SET Isoprobe II – 100:1	Max. 1000 V, CAT II (600 V, CAT III) (max. 3540 V, CAT I)	 	23

### Supplied components

Isoprobe II – 100:1 Page 22	
ZGA-S Page 37	
GS400 Page 38	
GM200 Page 40	

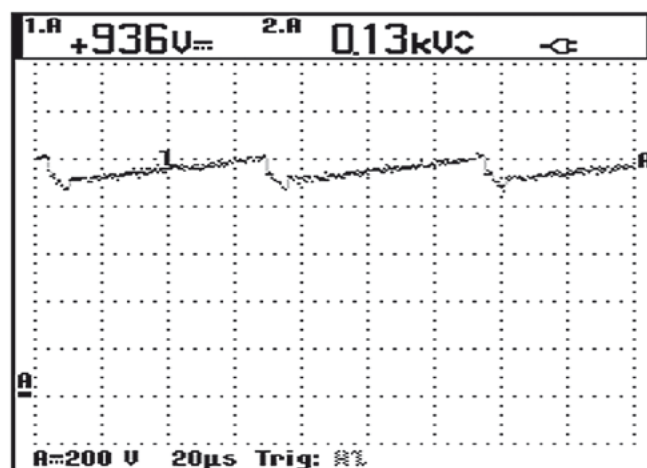

RZ Sheet RZ043

[www.staubli.com/electrical](http://www.staubli.com/electrical)

# Touch-protected Passive Oscilloscope Probes Isoprobe III and Probe Sets

## Isoprobe III – 10:1 ECO

Safety high-frequency 10:1 test probe. Highly flexible PVC-insulated coaxial connecting lead with BNC plug with integrated compensation unit. Ø 2 mm safety socket

for reference lead connection in the handling part of the probe. Good value for money.

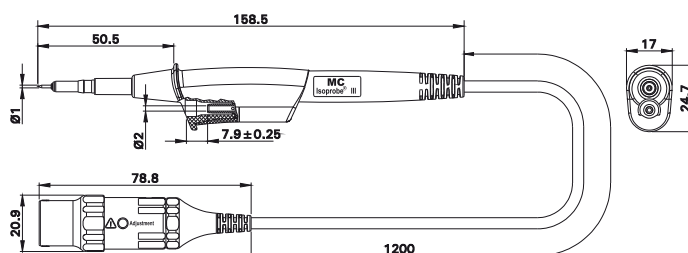

Order No.	Type		Lead length [cm]	Colour
68.9501-12028	Isoprobe III – 10:1 ECO	PVC CE UL LISTED	120	28

Technical Data	
Rated voltage (frequency-dependent)	Max. 600 V, CAT III (600 V, CAT IV)
Dividing ratio	10:1
Input capacitance	12 pF
Compensation range (works setting)	10 pF ... 22 pF (15 pF)
Input impedance	10 MΩ
Frequency range	0 ... 500 MHz
Rise time	0.9 ns
Lead length	120 cm



RZ Sheet RZ086

[www.staubli.com/electrical](http://www.staubli.com/electrical)





## SET Isoprobe III – 10:1 ECO





The basic set Isoprobe III - 10:1 ECO includes a basic set of accessories for effect-

ing safe and accurate high-frequency measurements. Good value for money.

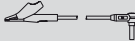

Order No.	Type	Rated voltage		Colour
68.9558-28	SET Isoprobe III – 10:1 ECO	Max. 600 V, CAT III (600 V, CAT IV)	 	28

### Supplied components

Isoprobe III – 10:1 ECO Page 25	
ZGA-S Page 37	
GS400 Page 38	
GM284 Page 40	
SK-IP Page 39	
SCC Page 40	

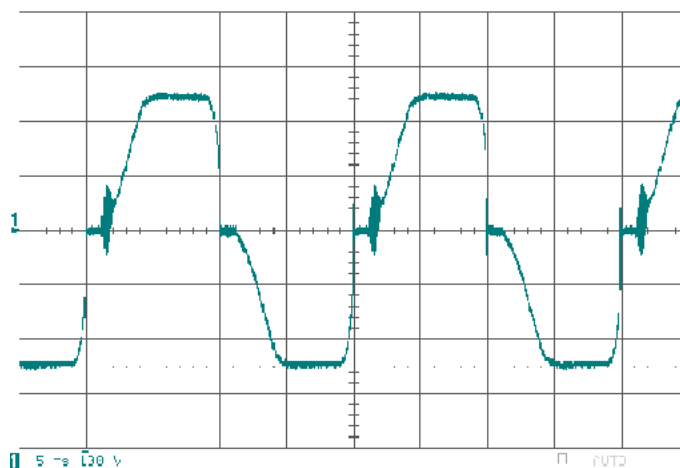

RZ Sheet RZ086

[www.staubli.com/electrical](http://www.staubli.com/electrical)

## Isoprobe III – 10:1 HF

Safety high-frequency 10:1 test probe with wide frequency range combined with low input capacitance. Highly flexible PVC-

insulated coaxial connecting lead with BNC plug with integrated compensation unit.

Ø 2 mm safety socket for reference lead connection in the handling part of the probe.

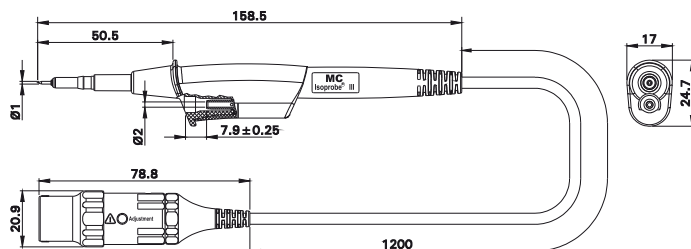

Order No.	Type		Lead length [cm]	Colour
68.9534-12028	Isoprobe III – 10:1 HF	PVC CE cULus LISTED	120	28

Technical Data		
Rated voltage (frequency-dependent)	Max. 1000 V, CAT III (600 V, CAT IV)	
Dividing ratio	10:1	
Input capacitance	12 pF	
Compensation range (works setting)	10 pF ... 22 pF (15 pF)	
Input resistance	10 MΩ	
Frequency range	0 ... 500 MHz	
Rise time	0.9 ns	
Lead length	120 cm	



RZ Sheet RZ084

[www.staubli.com/electrical](http://www.staubli.com/electrical)

## SET Isoprobe III – 10:1 HF







The Isoprobe III - 10:1 HF set with an extensive range of accessories meets the needs

of the professionally equipped electronic engineer.

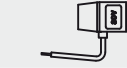

Order No.	Type	Rated voltage		Colour
68.9556-28	SET Isoprobe III – 10:1 HF	Max. 1000 V, CAT III (600 V, CAT IV)	CE 	28

### Supplied components

Isoprobe III – 10:1 HF Page 27			
ZGA-S Page 37		SK-IP Page 39	
GS400 Page 38		SCC Page 40	
GH284 Page 39			
GM284 Page 40			

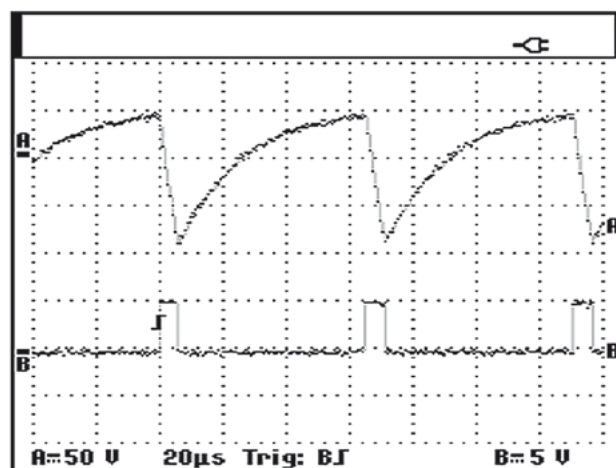

RZ Sheet RZ084

[www.staubli.com/electrical](http://www.staubli.com/electrical)

## Isoprobe III – 10:1 HS

Safety high-frequency 10:1 test probe. Highly flexible PVC-insulated coaxial connecting lead with BNC plug with integrated

compensation unit. Ø 2 mm safety socket for reference lead connection in the handling part of the probe.

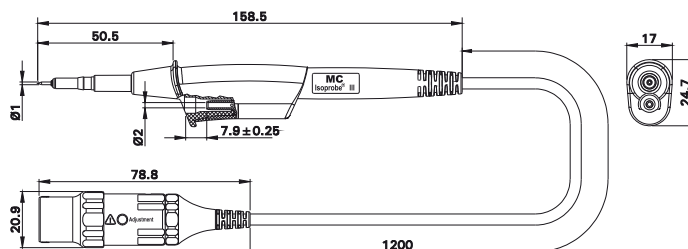

Order No.	Type		Lead length [cm]	Colour
68.9533-12028	Isoprobe III – 10:1 HS	PVC CE cUL LISTED	120	28

Technical Data		
Rated voltage (frequency-dependent)	Max. 1000 V, CAT III (600 V, CAT IV)	
Dividing ratio	10:1	
Input capacitance	13.5 pF	
Compensation range (works setting)	10 pF ... 30 pF (25 pF)	
Input resistance	10 MΩ	
Frequency range	0 ... 300 MHz	
Rise time	1.1 ns	
Lead length	120 cm	



RZ Sheet RZ085

[www.staubli.com/electrical](http://www.staubli.com/electrical)

## SET Isoprobe III – 10:1 HS

The particularly comprehensive accessories of the set Isoprobe III - 10:1 HS include, among others, two jaw clips for applications







such as test connections to busbars. This set addresses itself to heavy-current engi-

neers who make measurements directly on the mains.

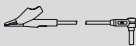

Order No.	Type	Rated voltage		Colour
68.9557-28	SET Isoprobe III – 10:1 HS	Max. 1000 V, CAT III (600 V, CAT IV)	CE 	28

### Supplied components

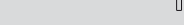
Isoprobe III – 10:1 HS Page 29			
ZGA-S Page 37		SK-IP Page 39	
AC200 Page 37		SCC Page 40	
GM284 Page 40			
AB200 Page 39			
GB284 Page 40			

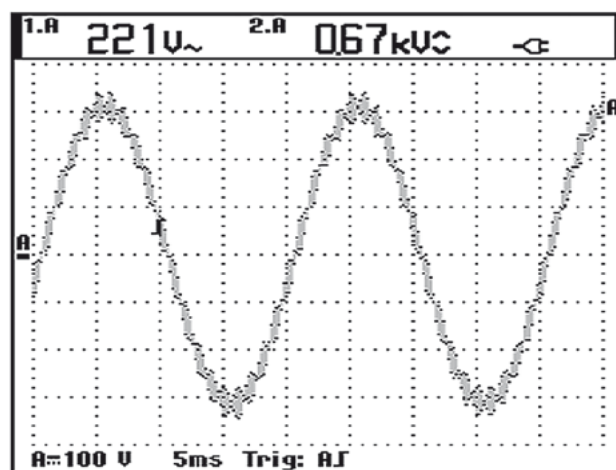

RZ Sheet RZ085

[www.staubli.com/electrical](http://www.staubli.com/electrical)

## Isoprobe III – 10:1 – 2,5

Safety high-frequency 10:1 test probe. Highly flexible PVC-insulated coaxial connecting lead with BNC plug with integrated compensation unit. Ø 2 mm safety socket for reference lead connection in the handling

part of the probe. With long connecting lead, specially suited for bridging long distances between the test instrument and the object under test.

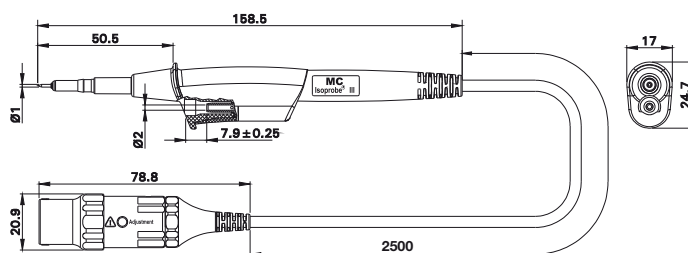

Order No.	Type		Lead length [cm]	Colour
68.9549-25028	Isoprobe III – 10:1 – 2,5	PVC CE cUL LISTED	250	28

Technical Data		
Rated voltage (frequency-dependent)	Max. 1000 V, CAT III (600 V, CAT IV)	
Dividing ratio	10:1	
Input capacitance	18 pF	
Compensation range (works setting)	10 pF ... 30 pF (15 pF)	
Input resistance	10 MΩ	
Frequency range	0 ... 250 MHz	
Rise time	1.3 ns	
Lead length	250 cm	



RZ Sheet RZ088



[www.staubli.com/electrical](http://www.staubli.com/electrical)

## SET Isoprobe III – 10:1 – 2,5





Test probe set, consisting of safety high-frequency test probe Isoprobe III - 10:1 - 2,5 and accessories. The test probe with long

connecting lead is specially suited for bridging long distances between the test instrument and the object under test.

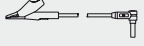

Order No.	Type	Rated voltage		Colour
68.9554-28	SET Isoprobe III – 10:1 – 2,5	Max. 1000 V, CAT III (600 V, CAT IV)	 	28

### Supplied components

Isoprobe III – 10:1 – 2,5 Page 30	
ZGA-S Page 37	
GM284 Page 40	
SK-IP Page 39	
SCC Page 40	



RZ Sheet RZ088

[www.staubli.com/electrical](http://www.staubli.com/electrical)

## Isoprobe III – 100:1

Safety high-frequency 100:1 test probe for safe measurements at high voltages. Highly flexible PVC-insulated coaxial connecting lead with BNC plug with integrated compen-

sation unit. Ø 2 mm safety socket for reference lead connection in the handling part of the probe. As a result of its low input capacitance and high input resistance, the probe

is also ideally suited for measurements on sensitive circuits.

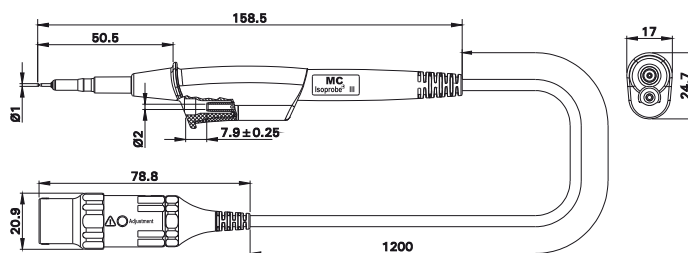

Order No.	Type		Lead length [cm]	Colour
68.9548-12023	Isoprobe III – 100:1	PVC CE UL LISTED	120	23

Technical Data		
Rated voltage (frequency-dependent)	Max. 1000 V, CAT III (600 V, CAT IV) (Max. 3540 V, CAT I)	
Dividing ratio	100:1	
Input capacitance	4.6 pF	
Compensation range (works setting)	10 pF ... 25 pF (15 pF)	
Input resistance	100 MΩ	
Frequency range	0 ... 500 MHz	
Rise time	0.9 ns	
Lead length	120 cm	



RZ Sheet RZ087

[www.staubli.com/electrical](http://www.staubli.com/electrical)



## SET Isoprobe III – 100:1





Test probe set for safe measurements at high voltages. Due to the low input capacity and high input impedance of the probe, the Set

Isoprobe III - 100:1 is also particularly suited for measurements on sensitive circuits.

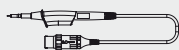

Order No.	Type	Rated voltage		Colour
68.9559-23	SET Isoprobe III – 100:1	Max. 1000 V, CAT III (600 V, CAT IV) (max. 3540 V, CAT I)	CE 	23

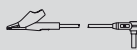
### Supplied components

Isoprobe III – 100:1 Page 32	
ZGA-S Page 37	
GS400 Page 38	
GM284 Page 40	
SK-IP Page 39	
SCC Page 40	

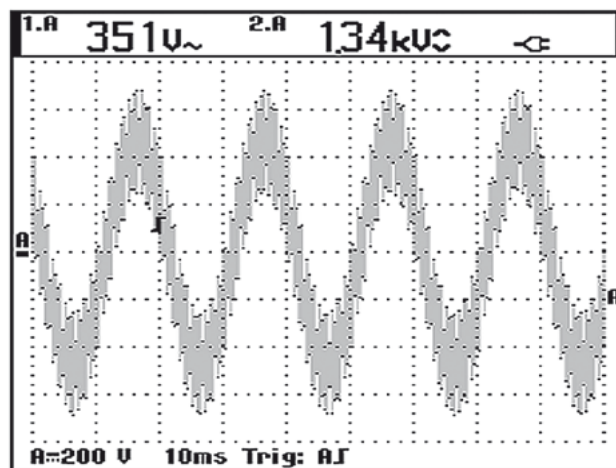

RZ Sheet RZ087

[www.staubli.com/electrical](http://www.staubli.com/electrical)

# High-pass Oscilloscope Probe: Isoprobe III-HP

**With Isoprobe III - HP we have added a probe with an integrated high-pass filter to our Isoprobe III range of touch-protected high-frequency probes.**

The new development can, for instance, be used for transient measurement in network analysis.

The insulators are designed for max. 1000 V, CAT III resp. 600 V, CAT IV (frequency-dependent) in accordance with IEC / EN 61010-031, which allows safe use in corresponding environments – provided that appropriate accessories and test instruments are used.

The integrated high-pass filter suppresses the low-frequency components of a signal (still present on the left), thus improving visibility of the high-frequency components such as transients (right).



The Isoprobe III - HP probe is available both separately and in a set with ample accessories.

**Accessories of SET Isoprobe III - HP:**

- ZGA-S: Push-on hook clip
  - GM284: Reference lead with crocodile clip
  - SK-IP: Push-on insulating sleeve
  - SCC: Set of colour clips
- \*: Protective cap



## Isoprobe III – HP

Safety high-frequency oscilloscope probe with an integrated high-pass filter. Highly flexible PVC-insulated coaxial connecting

lead with BNC plug. Ø 2 mm safety socket for reference lead connection in the handling part of the probe.



RZ Sheet RZ100

[www.staubli.com/electrical](http://www.staubli.com/electrical)

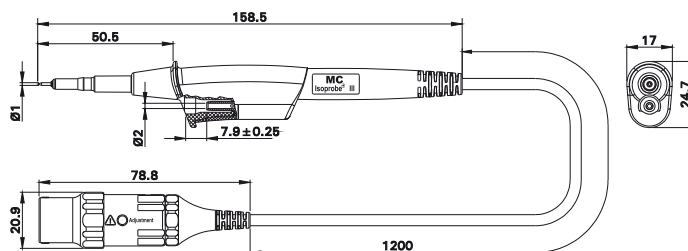

Order No.	Type		Lead length [cm]	Colour
68.9455-12028	Isoprobe III – HP	PVC	120	28

### Technical Data

Rated voltage (frequency-dependent)	Max. 1000 V, CAT III (600 V, CAT IV) (Max. 3540 V, CAT I)
Dividing ratio ( $\pm 3\%$ , $f=10$ kHz)	100:1 ( $f > 1,1$ kHz)
Attenuation ( $f = 50$ Hz compared with 10 kHz)	> 40dB
Input capacitance	< 8 pF
Scope capacitance	12 pF ... 25 pF
Input resistance	100 M $\Omega$
Frequency range	1.1 kHz ... 35 MHz (3 dB)
Rise time	< 10ns
Lead length	120 cm

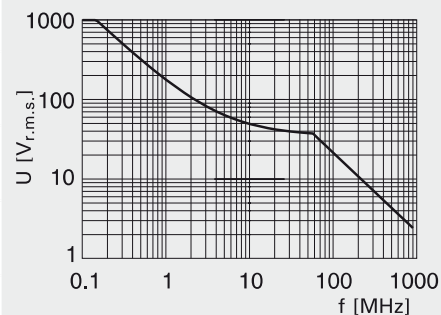

## SET Isoprobe III – HP

The set Isoprobe III - HP contains accessories to meet the needs of a professionally equipped test engineer.



Order No.	Type	Rated voltage		Colour
68.9456-28	SET Isoprobe III – HP	Max. 1000 V, CAT III (600 V, CAT IV) (max. 3540 V, CAT I)	PVC CE	28

### Supplied components

Isoprobe III – HP Page 35	
ZGA-S Page 37	
GM284 Page 40	
SK-IP Page 39	
SCC Page 40	



RZ Sheet RZ100

[www.staubli.com/electrical](http://www.staubli.com/electrical)

# Isoprobe II / III – Accessories

## HC200

Push-on hook clip.

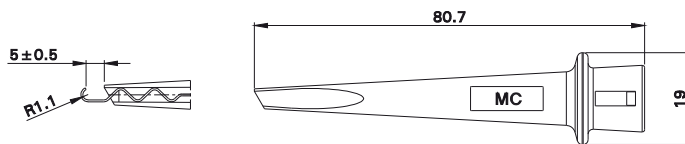

Order No.	Type	Rated voltage		*Colours
68.9480-*	HC200	1000 V, CAT II (600 V, CAT III)		<span style="background-color: black; color: white; padding: 2px;">21</span> <span style="background-color: red; color: white; padding: 2px;">22</span> <span style="background-color: blue; color: white; padding: 2px;">23</span> <span style="background-color: gray; color: white; padding: 2px;">28</span>

## ZGA

Push-on hook clip.

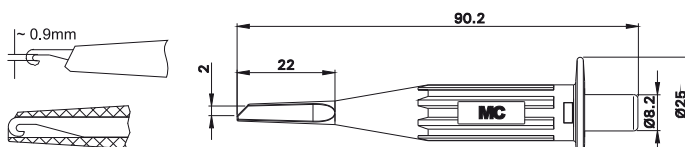

Order No.	Type	Rated voltage		*Colours
68.9817-*	ZGA	1000 V, CAT II (600 V, CAT III)		<span style="background-color: black; color: white; padding: 2px;">21</span> <span style="background-color: red; color: white; padding: 2px;">22</span> <span style="background-color: blue; color: white; padding: 2px;">23</span> <span style="background-color: gray; color: white; padding: 2px;">28</span>

## ZGA-S

Push-on hook clip.

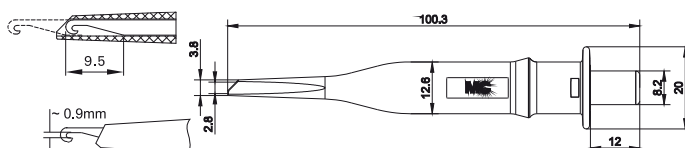

Order No.	Type	Rated voltage		*Colours
68.9805-*	ZGA-S	1000 V, CAT III (600 V, CAT IV) (max. 3540 V, CAT I)		<span style="background-color: blue; color: white; padding: 2px;">23</span> <span style="background-color: gray; color: white; padding: 2px;">28</span>

## AC200

Push-on safety jaw clip. For increased safety when making connections, the jaws are insulated on the outside.

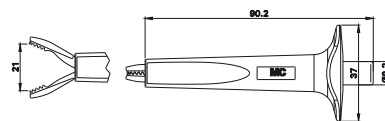

Order No.	Type	Rated voltage		*Colours
68.9485-*	AC200	1000 V, CAT III (600 V, CAT IV)		<span style="background-color: black; color: white; padding: 2px;">21</span> <span style="background-color: red; color: white; padding: 2px;">22</span> <span style="background-color: blue; color: white; padding: 2px;">23</span> <span style="background-color: gray; color: white; padding: 2px;">28</span>

## PB200

Push-on Ø 4 mm test probe.

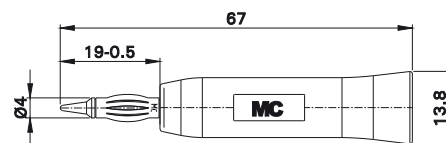

Order No.	Type	Rated voltage		*Colours
68.9481-*	PB200	1000 V, CAT II		<span style="background-color: black; color: white; padding: 2px;">21</span> <span style="background-color: red; color: white; padding: 2px;">22</span> <span style="background-color: blue; color: white; padding: 2px;">23</span> <span style="background-color: gray; color: white; padding: 2px;">28</span>

## PT200

Push-on Ø 2 mm test probe.

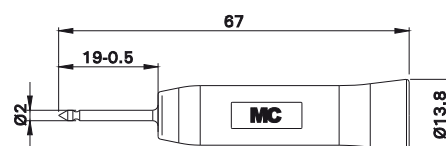

Order No.	Type	Rated voltage		*Colours
68.9483-*	PT200	1000 V, CAT II		<span style="background-color: black; color: white; padding: 2px;">21</span> <span style="background-color: red; color: white; padding: 2px;">22</span> <span style="background-color: blue; color: white; padding: 2px;">23</span> <span style="background-color: gray; color: white; padding: 2px;">28</span>

## GS400

Push-on reference contact.

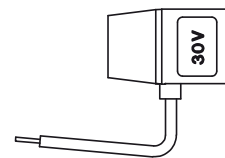

Order No.	Type	Rated voltage		Colour
68.9443-21	GS400	30 V <sub>AC</sub> / 60 V <sub>DC</sub>		<span style="background-color: black; color: white; padding: 2px;">21</span>

## XTBA

Push-on BNC male connector.

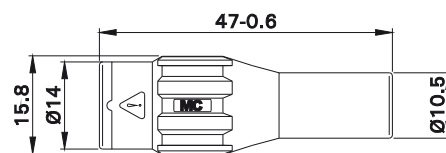

Order No.	Type	Rated voltage		*Colours
68.9809-*	XTBA	Max. 1000 V, CAT II (600 V, CAT III)		<span style="background-color: black; color: white; padding: 2px;">21</span> <span style="background-color: red; color: white; padding: 2px;">22</span> <span style="background-color: blue; color: white; padding: 2px;">23</span>



RZ Sheet RZ013

[www.staubli.com/electrical](http://www.staubli.com/electrical)

## SK-IP

Push-on insulating sleeve.

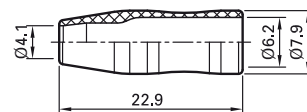

Order No.	Type	*Colours
68.9514-*	SK-IP	23 28

## AB200

Test clip with steel jaws especially for connections to ground rails and thick cables. For increased safety when making connec-

tions, the jaws are insulated on the outside. Ø 4 mm rigid socket in handle accepting

spring-loaded Ø 4 mm plugs with rigid insulating sleeve.

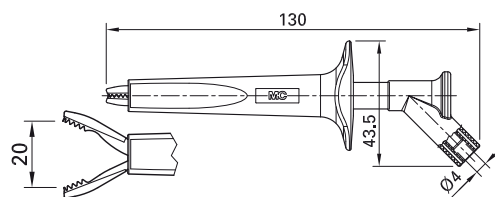

Order No.	Type	Rated voltage/current		*Colours
66.9474-*	AB200	1000 V, CAT IV / 20 A	Ni CE cUL <sub>US</sub> LISTED	21 22 23 28

## GH200 GH284

Ø 2 mm Reference lead with hook clip (length 15 cm).

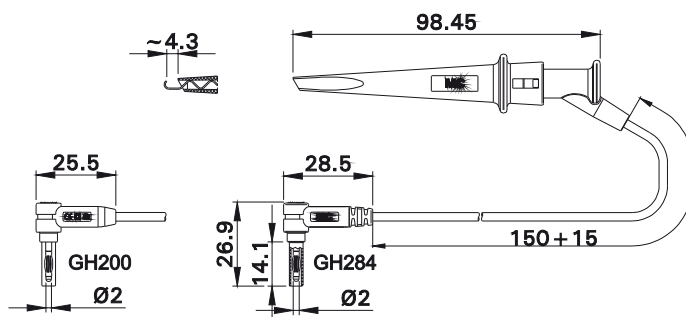

Order No.	Type	Rated voltage	Lead cross section		Lead length [cm]	Colour
68.9486-01521	GH200	1000 V, CAT II (600 V, CAT III)	0.50 mm <sup>2</sup>	SIL CE cUL <sub>US</sub> LISTED	015	21
68.9519-01521	GH284	1000 V, CAT III (600 V, CAT IV)	0.50 mm <sup>2</sup>	SIL CE cUL <sub>US</sub> LISTED	015	21

GM200-F GM200 GM284

Highly flexible reference leads with insulation in PVC or silicone. One end with right

angled Ø 2 mm plug with rigid insulating sleeve, other end with crocodile clip with all-

round insulation and toothed gripping jaws with fine-wire clamping surface.

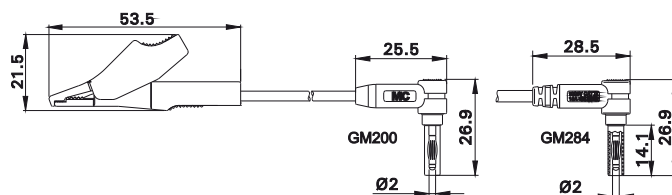

Order No.	Type	Rated voltage/current	Lead cross section		Lead length [cm]	Colour
68.9488-02521	GM200-F	1000 V, CAT II (600 V, CAT III) / 10 A	0.50 mm <sup>2</sup>	SIL CE cUL <sup>US</sup> LISTED	025	21
68.9487-02521	GM200	1000 V, CAT II (600 V, CAT III) / 10 A	0.50 mm <sup>2</sup>	SIL CE cUL <sup>US</sup> LISTED	025	21
68.9517-02521	GM284	1000 V, CAT III (600 V, CAT IV) / 10 A	0.50 mm <sup>2</sup>	SIL CE cUL <sup>US</sup> LISTED	025	21

GB200 GB284

Highly flexible Silicone-insulated reference leads. One end with Ø 2 mm safety plug,

other end with Ø 4 mm safety plug. Lead length: 50 cm.

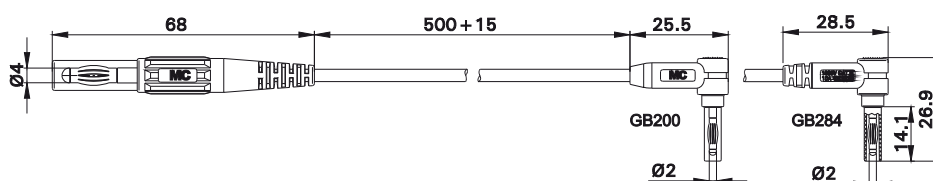

Order No.	Type	Rated voltage/current	Lead cross section		Lead length [cm]	Colour
68.9489-05021	GB200	1000 V, CAT II (600 V, CAT III) / 10 A	0.75 mm <sup>2</sup>	SIL CE cUL <sup>US</sup> LISTED	050	21
68.9518-05021	GB284	1000 V, CAT III (600 V, CAT IV) / 10 A	0.75 mm <sup>2</sup>	SIL CE cUL <sup>US</sup> LISTED	050	21

SCC

Set of colour clips for Isoprobe connecting lead (5 x 2 pcs.).

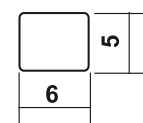
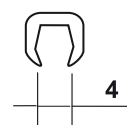

Order No.	Type
68.9513	SCC



# BNC Safety Test Leads

## XLSS-58 XLSK-58

Touch-protected coaxial test leads. Versions with BNC male connectors on both ends or with male and female connector. The shield

of the BNC connectors is nickel-plated, the contact pins and sockets of the inner conductor are in gold-plated brass.



RZ Sheet RZ013, 014

[www.staubli.com/electrical](http://www.staubli.com/electrical)

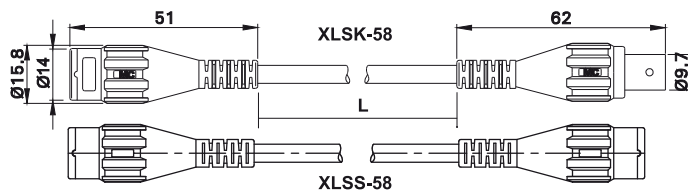

Order No.	Type		Lead lengths L [cm]	*Colours
67.9770- <input type="checkbox"/> *	XLSS-58	Au Ni PVC CE C-UL US LISTED ⚠ RZ 014	050 100 150 200	21 22 23
67.9773- <input type="checkbox"/> *	XLSK-58	Au Ni PVC CE C-UL US LISTED ⚠ RZ 013	050 100 150 200	21 22 23

Technical Data		
Type	XLSS-58	XLSK-58
Rated voltage	1000 V, CAT II (600 V, CAT III)	600 V, CAT II (300 V, CAT III)
Impedance	50 Ω	50 Ω
Capacity	60 pF (L = 50 cm) 113 pF (L = 100 cm) 166 pF (L = 150 cm) 219 pF (L = 200 cm)	60 pF (L = 50 cm) 113 pF (L = 100 cm) 166 pF (L = 150 cm) 219 pF (L = 200 cm)
Inductance	170 nH (L = 50 cm) 340 nH (L = 100 cm) 510 nH (L = 150 cm) 680 nH (L = 200 cm)	170 nH (L = 50 cm) 340 nH (L = 100 cm) 510 nH (L = 150 cm) 680 nH (L = 200 cm)
VSWR (frequency-dependent)		
Attenuation (frequency-dependent)		
Coaxial lead / Insulation	RG58 / PVC	RG58 / PVC
Coaxial lead / Temperature range	-10°C ... +70°C	-10°C ... +70°C

## XLSS-174

Touch-protected PVC-insulated coaxial test leads. Version with BNC male connector

on both ends. The shield of the BNC connectors is nickel-plated, the contact pins

and sockets of the inner conductor are in gold-plated brass.

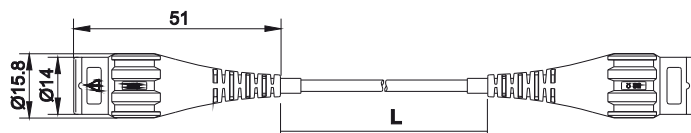

Order No.	Type		Lead lengths L [cm]	*Colours
67.9553- <input type="text"/> 21	XLSS-174	<b>Au Ni PVC</b>	<input type="text"/> 050 <input type="text"/> 100 <input type="text"/> 150 <input type="text"/> 200	<input type="text"/> 21

Technical Data	
Rated voltage	600 V, CAT II (300 V, CAT III)
Impedance	50 Ω
Capacity	60 pF (L = 50 cm) 113 pF (L = 100 cm) 166 pF (L = 150 cm) 219 pF (L = 200 cm)
Inductance	225 nH (L = 50 cm) 450 nH (L = 100 cm) 675 nH (L = 150 cm) 900 nH (L = 200 cm)
VSWR (frequency-dependent) Typical values!	
Attenuation (frequency-dependent) <b>RG174</b> <b>RG58</b> <b>SILI-SC 0,5/1,0</b>	
Coaxial lead / Insulation	RG174 / PVC
Coaxial lead / Temperature range	-10°C ... +70°C



RZ Sheet RZ013

[www.staubli.com/electrical](http://www.staubli.com/electrical)

## XLSS/SIL

Touch-protected silicone insulated coaxial test leads with BNC male connectors on

both ends, e. g. for connecting measuring instruments. The shield of the BNC connec-

tors is nickel-plated, the contact pins of the inner conductor are in gold-plated brass.

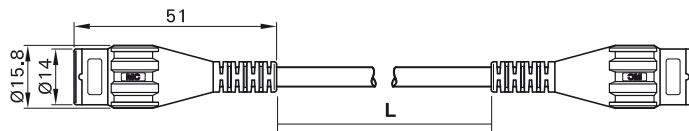

Order No.	Type		Lead lengths L [cm]	*Colours
67.9756- <input type="text"/> *	XLSS/SIL	Au Ni SIL CE cULUS LISTED	050 100 150 200	21 22 23

Technical Data	
Rated voltage	1000 V, CAT II (600 V, CAT III)
Impedance	~ 45 Ω
Capacity	85 pF (L = 50 cm) 162 pF (L = 100 cm) 240 pF (L = 150 cm) 317 pF (L = 200 cm)
Inductance	160 nH (L = 50 cm) 320 nH (L = 100 cm) 480 nH (L = 150 cm) 640 nH (L = 200 cm)
Attenuation (frequency-dependent)	<p>RG174 RG58 SILI-SC 0,5/1,0</p>
Coaxial lead / Insulation	SILI-SC 0,5/1,0 / Silicon
Coaxial lead / Temperature range	-50°C ... +150°C



### RZ Sheet RZ014

[www.staubli.com/electrical](http://www.staubli.com/electrical)

#### Note:

In the assembly of BNC leads for use in the high-frequency range, the plugs and coax cables must be carefully matched in order to ensure unimpaired signal transmission. We will be pleased to advise you. In our main catalogue for cables and multistrand wires you will

find highly flexible silicone and PVC insulated coaxial leads in various colours together with a wide range of other multi-strand cables. Order it now!

**XLWW-58 XLWW/SIL**

Touch-protected PVC or silicone insulated coaxial test leads with BNC male connectors on both ends, angled for ergonomic

cable arrangement and rotatable through 360° about the plugging axis. The shield of the BNC connectors is nickel-plated, the

contact pins of the inner conductor are in gold-plated brass.

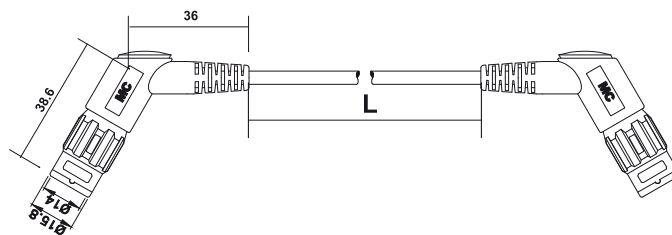

Order No.	Type	Wire type		Lead lengths L [cm]	*Colours
67.9551- <input type="checkbox"/> *	XLWW-58	RG58	Au Ni PVC CE C <sub>UL</sub> LISTED	050 100 150 200	21 22 23
67.9552- <input type="checkbox"/> *	XLWW/SIL	SILI-SC 0,5/1,0	Au Ni SIL CE C <sub>UL</sub> LISTED	050 100 150 200	21 22 28

Technical Data		
Type	XLWW-58	XLWW/SIL
Rated voltage	1000 V, CAT II (600 V, CAT III)	1000 V, CAT II (600 V, CAT III)
Impedance	50 Ω	~ 45 Ω
Capacity	67 pF (L = 50 cm) 120 pF (L = 100 cm) 173 pF (L = 150 cm) 226 pF (L = 200 cm)	92 pF (L = 50 cm) 169 pF (L = 100 cm) 247 pF (L = 150 cm) 324 pF (L = 200 cm)
Inductance	170 nH (L = 50 cm) 340 nH (L = 100 cm) 510 nH (L = 150 cm) 680 nH (L = 200 cm)	160 nH (L = 50 cm) 320 nH (L = 100 cm) 480 nH (L = 150 cm) 640 nH (L = 200 cm)
VSWR (frequency-dependent)  Typical values!		No data available.
Attenuation (frequency-dependent)  RG58 SILI-SC 0,5/1,0		
Coaxial lead (Type) / Insulation	RG58 / PVC	SILI-SC 0,5/1,0 / Silicon
Coaxial lead / Temperature range	-10°C ... +70°C	-50°C ... +150°C

# Touch-protected BNC Connectors and BNC Panel-mount Sockets

## XBS-58 XBK-58

Touch-protected BNC male and female connectors for production of touch-protected

BNC leads (RG58). Shield is nickel-plated, the contact pins and sockets of the inner

conductor are in gold-plated brass.

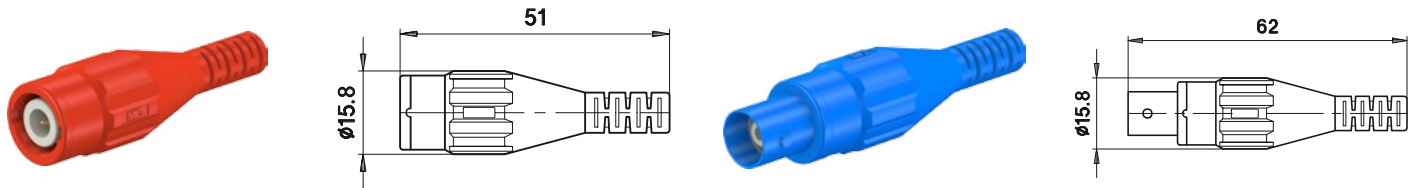

Order No.	Type	Assembly instructions		*Colours
67.9760-*	XBS-58	MAH 529	Au Ni	21 22 23 28
67.9762-*	XBK-58	MAH 540	Au Ni	21 22 23 28

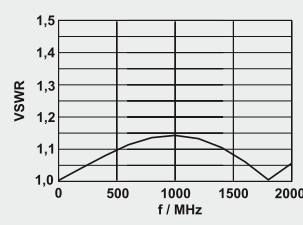
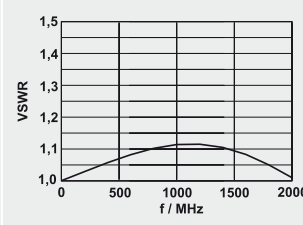
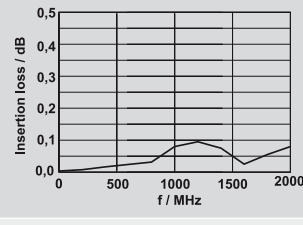
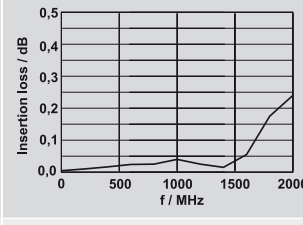
Technical Data			
Type	XBS-58	XBK-58	
Rated voltage / current	1000 V, CAT II (600 V, CAT III) / 1 A	600 V, CAT II (300 V, CAT III) / 1 A	
Frequency range	0 ... 3000 MHz	0 ... 3000 MHz	
VSWR (frequency-dependent) Typical values!	f = 2000 MHz: < 1.2 	f = 2000 MHz: < 1.2 	
Insertion loss (frequency-dependent) Typical values!	f = 2000 MHz: < 0.2 dB 	f = 2000 MHz: < 0.4 dB 	
Connectable coaxial lead: Type / outer diameter	RG58 / ~ Ø 5 mm	RG58 / ~ Ø 5 mm	
Temperature range	+5°C ... +40°C	+5°C ... +40°C	



Assembly instructions MAH 529, MAH 540

[www.staubli.com/electrical](http://www.staubli.com/electrical)

## XBB-C58

Touch-protected BNC panel-mount sockets for accepting BNC male connectors. The sockets can be screw-mounted into pre-drilled panels of plastic, metal, etc. Shield

is nickel-plated, the contact socket of the inner conductor is in gold-plated brass. Connection for RG58 cable.

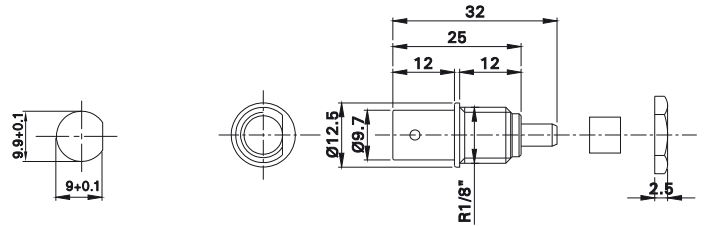
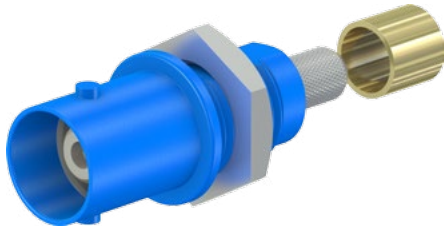

Order No.	Type	Shield connection		*Colours
67.9766-*	XBB-C58	RG58	Au Ni	<span style="background-color: black; color: white; padding: 2px;">21</span> <span style="background-color: red; color: white; padding: 2px;">22</span> <span style="background-color: blue; color: white; padding: 2px;">23</span> <span style="background-color: gray; color: white; padding: 2px;">28</span>

Technical Data	
Rated voltage / current	600 V, CAT II (300 V, CAT III) / 1 A
Frequency range	0 ... 3000 MHz
VSWR (frequency-dependent) Typical values!	<p>f = 2000 MHz: &lt; 1.2</p>
Insertion loss (frequency-dependent) Typical values!	<p>f = 2000 MHz: &lt; 0.4 dB</p>
Connection inner conductor	Contact socket (brass, gold-plated) for crimp or solder connection
Shield connection	Crimp connection (brass, nickel-plated) for RG58
Temperature range	+5°C ... +40°C



Assembly instructions MAH 542

[www.staubli.com/electrical](http://www.staubli.com/electrical)

## XBB-L XBB-LL

Touch-protected BNC panel-mount sockets for accepting BNC male connectors. The sockets can be screw-mounted into pre-

drilled panels of plastic, metal, etc. Shield is nickel-plated, the contact socket of the inner conductor is in gold-plated brass. Type

XBB-LL with extended shield for better radiation suppression in unmated condition. Solder connection.

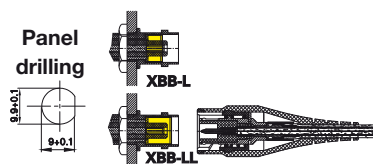
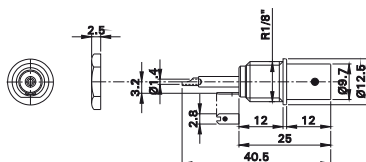

Order No.	Type	Type of shield		*Colours
67.9764-*	XBB-L	short	Au Ni Ag	21 22 23 28
67.9571-*	XBB-LL	long	Au Ni Ag	21 22 23 28

Technical Data		
Type	XBB-L	XBB-LL
Rated voltage / current	1000 V, CAT II <sup>1)</sup> (600 V, CAT III) <sup>1)</sup> / 1 A 600 V, CAT II <sup>2)</sup> (300 V, CAT III) <sup>2)</sup> / 1 A	1000 V, CAT II <sup>1)</sup> (600 V, CAT III) <sup>1)</sup> / 1 A 600 V, CAT II <sup>2)</sup> (300 V, CAT III) <sup>2)</sup> / 1 A
Frequency range	0 ... 1500 MHz	0 ... 1500 MHz
VSWR (frequency-dependent)  Typical values!	f = 500 MHz: < 1.2 	f = 500 MHz: < 1.2 
	Insertion loss (frequency-dependent)  Typical values!	f = 500 MHz: < 0.2 dB 
Connection inner conductor	Round solder pin (brass, gold-plated)	Round solder pin (brass, gold-plated)
Shield connection	Solder connection (brass, silver-plated)	Solder connection (brass, silver-plated)
Temperature range	+5°C ... +40°C	+5°C ... +40°C



Assembly instructions MAH 530

[www.staubli.com/electrical](http://www.staubli.com/electrical)

<sup>1)</sup> For mounting into pre-drilled plastic housings (double insulation) or metal housings<sup>3)</sup> (basic insulation, with protective conductor)

<sup>2)</sup> For mounting into pre-drilled metal housings<sup>3)</sup> (double insulation, without protective conductor)

<sup>3)</sup> Panel thickness max. 3 mm

## XBB-P XBB-PL

Touch-protected BNC panel-mount sockets for accepting BNC male connectors. The sockets can be screw-mounted into pre-

drilled panels of plastic, metal, etc. Shield is nickel-plated, the contact socket of the inner conductor is in gold-plated brass. Type

XBB-PL with extended shield for better radiation suppression in unmated condition. Solder connection wires.

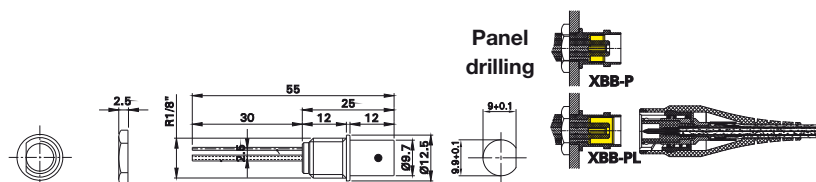
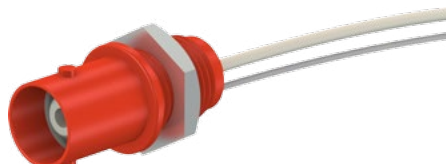

Order No.	Type	Type of shield		*Colours
67.9765-*	XBB-P	short	Au Ni Ag	21 22 23 28
67.9572-*	XBB-PL	long	Au Ni Ag	21 22 23 28

Technical Data		
Type	XBB-P	XBB-PL
Rated voltage / current	1000 V, CAT II <sup>1)</sup> (600 V, CAT III) <sup>1)</sup> / 1A 600 V, CAT II <sup>2)</sup> (300 V, CAT III) <sup>2)</sup> / 1A	1000 V, CAT II <sup>1)</sup> (600 V, CAT III) <sup>1)</sup> / 1A 600 V, CAT II <sup>2)</sup> (300 V, CAT III) <sup>2)</sup> / 1A
Frequency range	0 ... 2000 MHz	0 ... 2000 MHz
VSWR (frequency-dependent) Typical values (short connecting wires)!	f = 500 MHz: < 1.2 	f = 500 MHz: < 1.2 
Insertion loss (frequency-dependent) Typical values (short connecting wires)!	f = 500 MHz: < 0.2 dB 	f = 500 MHz: < 0.2 dB 
Connection inner conductor	Silver wire, Teflon insulated	Silver wire, Teflon insulated
Shield connection	Copper wire, silver-plated	Copper wire, silver-plated
Temperature range	+5°C ... +40°C	+5°C ... +40°C



Assembly instructions MAH 532

[www.staubli.com/electrical](http://www.staubli.com/electrical)

<sup>1)</sup> For mounting into pre-drilled plastic housings (double insulation) or metal housings<sup>3)</sup> (basic insulation, with protective conductor)

<sup>2)</sup> For mounting into pre-drilled metal housings<sup>3)</sup> (double insulation, without protective conductor)

<sup>3)</sup> Panel thickness max. 3 mm



## XBWB-P

Touch-protected BNC angled socket for mounting on printed-circuit boards, touch-protected according to IEC / EN 61010-1. The socket is directly soldered onto printed-circuit boards. The right-angled configuration minimises the force transmitted to the printed-circuit board through the plugged-in test lead.

The socket has a flat surface which provides sufficient protection from twisting when connecting a BNC cable.

The socket shield consists of two insulated, semi-circular contacts, which are connected to each other when a plug is inserted (switch function). The four locating pins are connected to additional shielding.

The contact socket of the inner conductor of the BNC socket is in gold-plated brass. For use, for example, with high-impedance insulated oscilloscope inputs. The touch-protected BNC socket is compatible with conventional BNC connectors. With such combinations, however, the 1000 V touch protection no longer applies to the whole system.

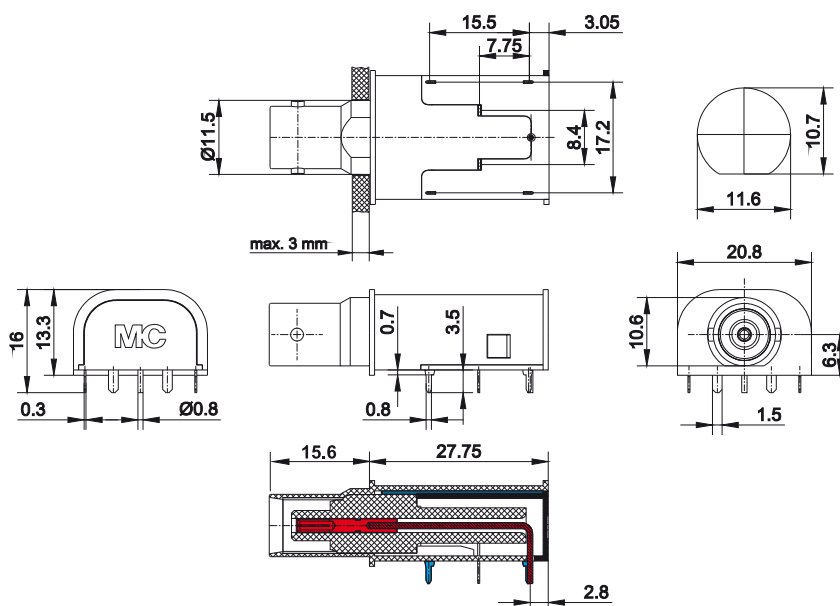

Order No.	Type	Rated voltage		*Colours
67.9569-*	XBWB-P	Max. 1000 V, CAT III (600 V, CAT IV)	Au Ni	21 22

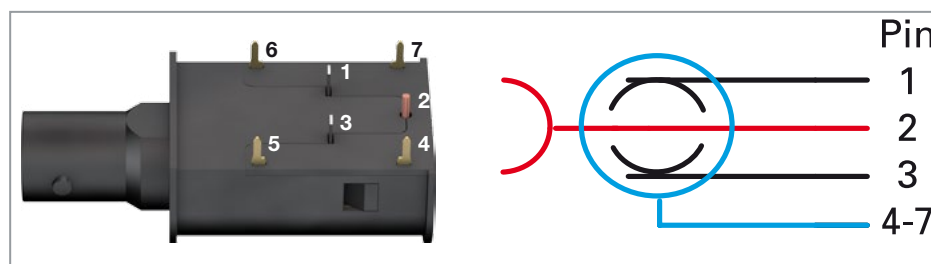

1	Outer conductor, semi-circular contact 1
2	Inner conductor
3	Outer conductor, semi-circular contact 2
4, 5, 6, 7	Additional shielding



Assembly instructions MAH 563

[www.staubli.com/electrical](http://www.staubli.com/electrical)

## XLAM-H200

Highly flexible BNC test lead. One end with two hook clips, other end with touch-

protected BNC male connector (red clip: BNC inner conductor / black clip: shield).



**RZ Sheet RZ013**

[www.staubli.com/electrical](http://www.staubli.com/electrical)

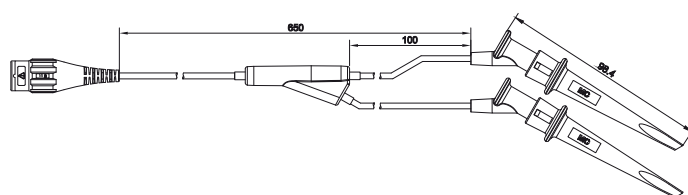
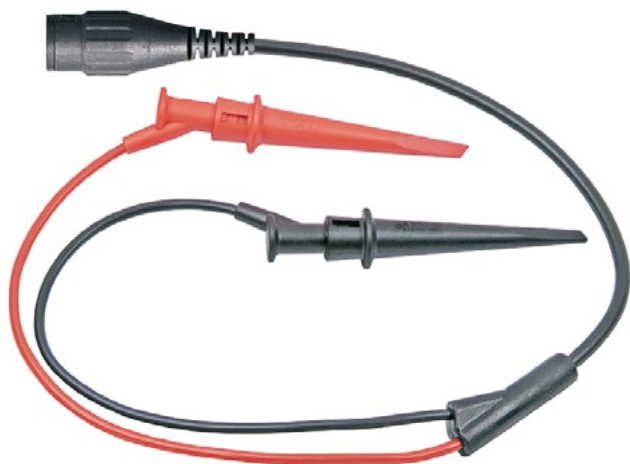

Order No.	Type	Rated voltage / current	Lead cross section		Lead lengths [cm]	*Colours
67.9424-065	XLAM-H200	600 V, CAT II (300 V, CAT III)	RG174 2x 1.0 mm <sup>2</sup>	PVC CE	065	

## XLAM-H200

Highly flexible BNC test lead. One end with two hook clips, other end with touch-

protected BNC male connector (red clip: BNC inner conductor / black clip: shield).

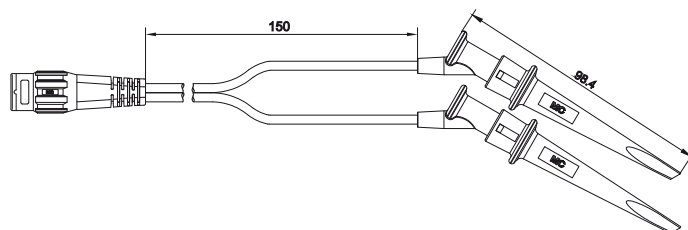

Order No.	Type	Rated voltage / current	Lead cross section		Lead lengths [cm]	*Colours
67.9419-015	XBH-200	1000 V, CAT II (600 V, CAT III)	2x 0.5 mm <sup>2</sup>	SIL CE	015	

# BNC / Ø 4 mm Adapters and Adapter Leads

XM-BB/4 XM-SS/4 XF-BB/4 XF-SS/4

XM-BB/4

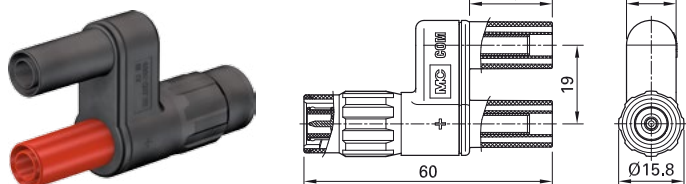

XM-SS/4

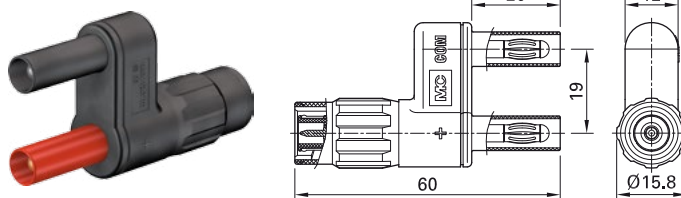

XF-BB/4

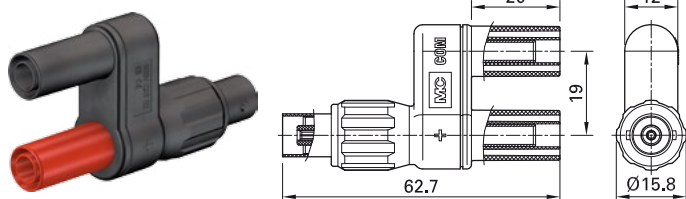

XF-SS/4

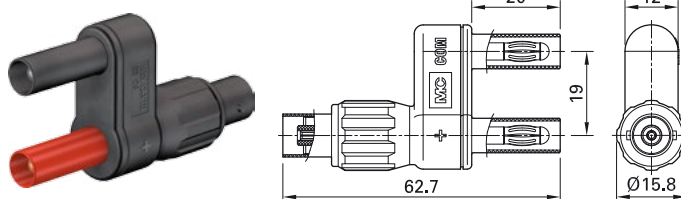

Order No.	Type	Rated voltage / current	BNC connector	Ø 4 mm connectors		Colour
67.9536-21	XM-BB/4	1000 V, CAT II (600 V, CAT III) / 1 A	BNC male connector	Ø 4 mm sockets	Au Ni CE cUL US LISTED	21
67.9535-21	XM-SS/4	1000 V, CAT II (600 V, CAT III) / 1 A	BNC male connector	Ø 4 mm plugs	Au Ni CE cUL US LISTED	21
67.9538-21	XF-BB/4	1000 V, CAT II (600 V, CAT III) / 1 A	BNC female connector	Ø 4 mm sockets	Au Ni CE cUL US LISTED	21
67.9537-21	XF-SS/4	1000 V, CAT II (600 V, CAT III) / 1 A	BNC female connector	Ø 4 mm plugs	Au Ni CE cUL US LISTED	21

## XM-B

One-pole adapter with touch-protected BNC male connector linked to a Ø 4 mm rigid socket, accepting spring-loaded Ø 4 mm plugs with rigid insulating sleeve.

The contact pin of the BNC plug connector is in gold-plated brass.



RZ Sheet RZ013

[www.staubli.com/electrical](http://www.staubli.com/electrical)

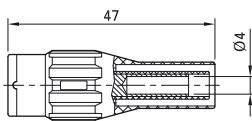

Order No.	Type	Rated voltage / current		*Colours
67.9799-*	XM-B	600 V, CAT II (300 V, CAT III) / 1 A	Au Ni CE	21 22 23

## XLAM-414/SC XLAM-414/SC/SIL

Highly flexible, fully shielded adapter leads.  
One end with coaxial cable with touch-protected BNC male connector, other end

with in-line Ø 4 mm MULTILAM plugs with rigid insulating sleeve.

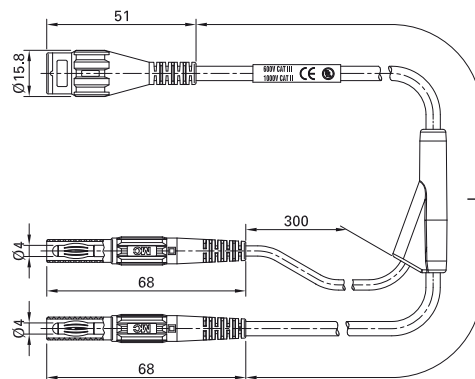

Order No.	Type		Lead lengths L [cm]	Colour
67.9842- <input type="checkbox"/>	XLAM-414/SC	Au Ni PVC CE	100 160	
67.9867- <input type="checkbox"/>	XLAM-414/SC/SIL	Au Ni SIL CE	100 160	

### Technical Data

Type	XLAM-414/SC	XLAM-414/SC/SIL
Rated voltage	1000 V, CAT II (600 V, CAT III)	1000 V, CAT II (600 V, CAT III)
Capacity (f = 100 kHz)	100 pF (L = 100 cm) 160 pF (L = 160 cm)	150 pF (L = 100 cm) 240 pF (L = 160 cm)
Inductance (f = 100 kHz)	750 nH (L = 100 cm) 1000 nH (L = 160 cm)	750 nH (L = 100 cm) 1000 nH (L = 160 cm)
Coaxial lead (Type) / Insulation	RG58 / PVC	SILI-SC 0,5/1,0 / Silicon
Temperature range	-10°C ... +70°C	-50°C ... +150°C

## BST-45

Highly flexible adapter lead. One end with touch-protected BNC male connector, other end with stackable Ø 4 mm MULTILAM plugs.

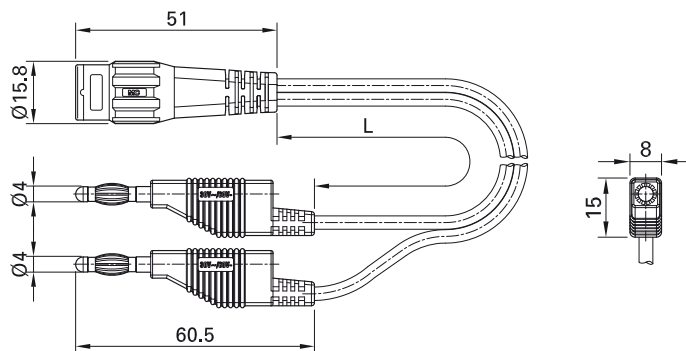
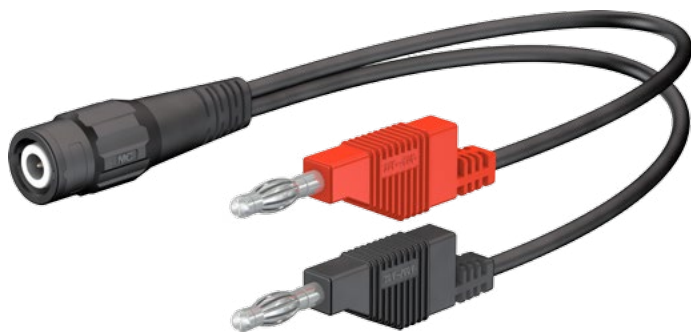

Order No.	Type	Rated voltage / current	Lead cross section		Lead lengths [cm]	*Colours
67.9417-025	BST-45	30 V <sub>AC</sub> ~ 60 V <sub>DC</sub>	2x 0.5 mm <sup>2</sup>	SIL	025	

**XLAM-446/SC XLAM-446/SC/SIL**

Highly flexible, fully shielded adapter leads. One end with coaxial cable with touch-protected BNC male connector, other end

with stackable Ø 4 mm MULTILAM plugs with rigid insulating sleeve.

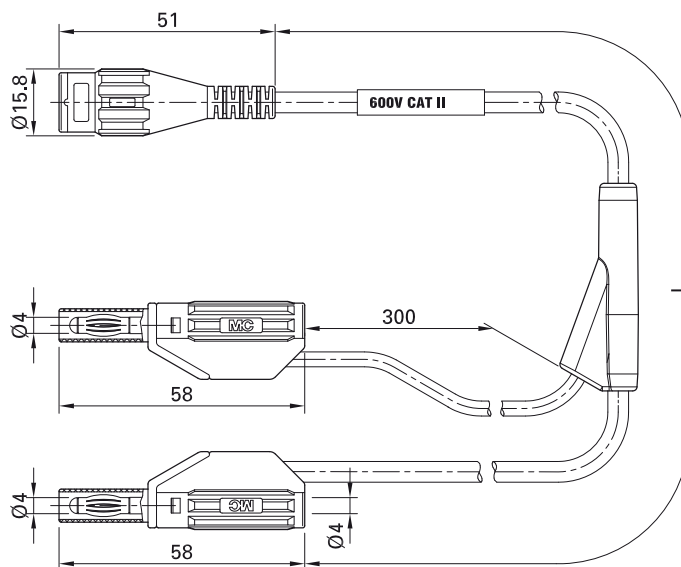

Order No.	Type		Lead lengths [cm]	Colour
67.9800- <input type="checkbox"/>	XLAM-446/SC	Au Ni PVC CE	100 160	
67.9868- <input type="checkbox"/>	XLAM-446/SC/SIL	Au Ni SIL CE	100 160	

Technical Data		
Type	XLAM-446/SC	XLAM-446/SC/SIL
Rated voltage	600 V, CAT II (300 V, CAT III)	600 V, CAT II (300 V, CAT III)
Capacity (f = 100 kHz)	100 pF (L = 100 cm) 160 pF (L = 160 cm)	150 pF (L = 100 cm) 240 pF (L = 160 cm)
Inductance (f = 100 kHz)	750 nH (L = 100 cm) 1000 nH (L = 160 cm)	750 nH (L = 100 cm) 1000 nH (L = 160 cm)
Coaxial lead (Type) / Insulation	RG58 / PVC	SILI-SC 0,5/1,0 / Silicon
Temperature range	-10°C ... +70°C	-50°C ... +150°C

## XDS-BS/58 XDS-BS/SIL

Highly flexible, fully shielded adapter leads. One end with coaxial cable with touch-protected BNC male connector, other end

with Ø 4 mm MULTILAM plugs with rigid insulating sleeve, two-pole version.

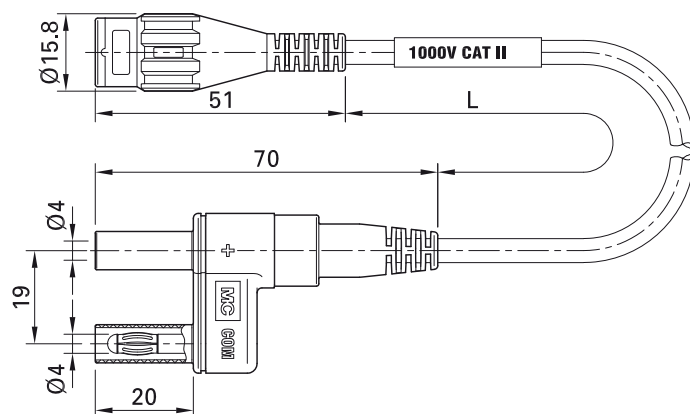

Order No.	Type		Lead lengths L [cm]	Colour
67.9539- <input type="checkbox"/> 21	XDS-BS/58	<b>Au</b> <b>Ni</b> <b>PVC</b> <b>CE</b>	<b>100</b> <b>160</b>	<b>21</b>
67.9540- <input type="checkbox"/> 21	XDS-BS/SIL	<b>Au</b> <b>Ni</b> <b>SIL</b> <b>CE</b>	<b>100</b> <b>160</b>	<b>21</b>

Technical Data		
Type	XDS-BS/58	XDS-BS/SIL
Rated voltage	1000 V, CAT II (600 V, CAT III)	1000 V, CAT II (600 V, CAT III)
Frequency range	ZL <sup>1)</sup> = 1 MΩ    16 pF: DC - 20 MHz (L = 100 cm) 1 MΩ    16 pF: DC - 15 MHz (L = 160 cm) 50 Ω : DC - 100 MHz	ZL <sup>1)</sup> = 1 MΩ    16 pF: DC - 20 MHz (L = 100 cm) 1 MΩ    16 pF: DC - 15 MHz (L = 160 cm) 50 Ω : DC - 100 MHz
Capacity (f = 100 kHz)	105 pF (L = 100 cm) 175 pF (L = 160 cm)	150 pF (L = 100 cm) 240 pF (L = 160 cm)
Inductance (f = 100 kHz)	500 nH (L = 100 cm) 650 nH (L = 160 cm)	600 nH (L = 100 cm) 850 nH (L = 160 cm)
Coaxial lead (Type) / Insulation	RG58 / PVC	SILI-SC 0,5/1,0 / Silicon
Temperature range	-10°C ... +70°C	-50°C ... +150°C

<sup>1)</sup> ZL = Load impedance

# BNC / Ø 2 mm Adapters and Adapter Leads

## XLAM-205L

Highly flexible adapter lead. One end with co-axial cable with touch-protected BNC male

connector, other end with in-line Ø 2 mm MULTILAM plugs with rigid insulating sleeve.

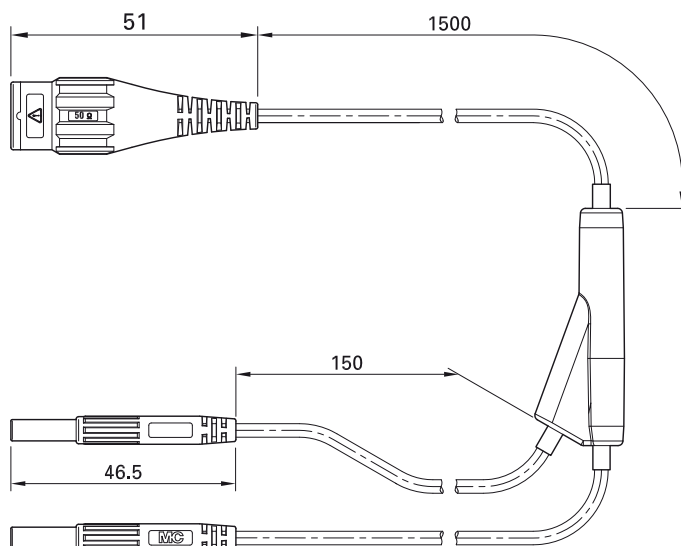

Order No.	Type	Rated voltage	Wire type		Lead lengths [cm]
67.9565-150	XLAM-205L	600 V, CAT II (300 V, CAT III)	RG174 2x 0.5 mm <sup>2</sup>	PVC	150



RZ Sheet RZ013

[www.staubli.com/electrical](http://www.staubli.com/electrical)



# BNC Lead Couplers

## XM-M

Lead coupler. The inner conductors and the shields are interconnected. The contact pins

of the inner conductor of the BNC plug connector are in gold-plated brass.

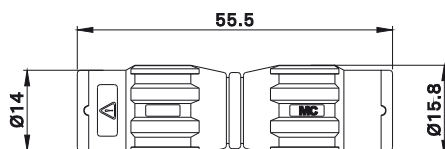

Order No.	Type	Rated voltage / current	Frequency range	VSWR		Colour
67.9546-28	XM-M	600 V, CAT II (300 V, CAT III) / 1 A	DC ... 500 MHz	< 1.3	Au Ni CE	28



RZ Sheet RZ013

[www.staubli.com/electrical](http://www.staubli.com/electrical)

## XF-F

Lead coupler. The inner conductors and the shields are interconnected. The contact

sockets of the inner conductor of the BNC plug connector are in gold-plated brass.

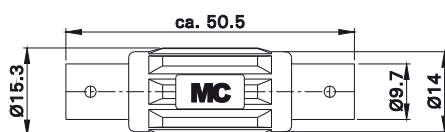

Order No.	Type	Rated voltage / current	Frequency range	VSWR		Colour
67.9547-28	XF-F	1000 V, CAT II (600 V, CAT III) / 1 A	DC ... 500 MHz	< 1.3	Au Ni CE	28



RZ Sheet RZ014

[www.staubli.com/electrical](http://www.staubli.com/electrical)

# BNC Signal Distributors

## XM-MM

Signal distributor with three BNC safety connectors. All inner conductors and all shields are interconnected. The contact pins of the

inner conductor of the BNC plug connector are in gold-plated brass.

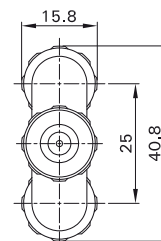
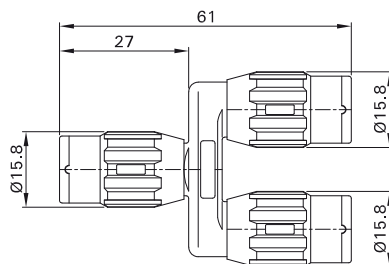

Order No.	Type	Rated voltage / current	Frequency range	VSWR		Colour
67.9782-21	XM-MM	600 V, CAT II (300 V, CAT III) / 1 A	-	-	Au Ni CE	21



RZ Sheet RZ013

[www.staubli.com/electrical](http://www.staubli.com/electrical)

## XM-FF

Signal distributor with three BNC safety connectors. All inner conductors and all shields are interconnected. The contact pins and

sockets of the inner conductor of the BNC plug connector are in gold-plated brass.

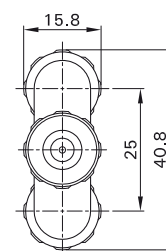
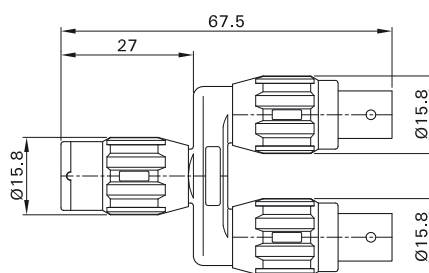

Order No.	Type	Rated voltage / current	Frequency range	VSWR		Colour
67.9783-21	XM-FF	600 V, CAT II (300 V, CAT III) / 1 A	-	-	Au Ni CE	21



RZ Sheet RZ013

[www.staubli.com/electrical](http://www.staubli.com/electrical)

# Touch-protected Adapters and Converters

Touch-protected adapters and converters with various functions in high-frequency technology. The BNC plug connectors allow these elements to be easily inserted, e.g. by direct plugging into an oscilloscope input

socket or as intermediate elements in BNC leads. The contact pins and sockets of the inner conductor of the BNC plug connector are in gold-plated brass.

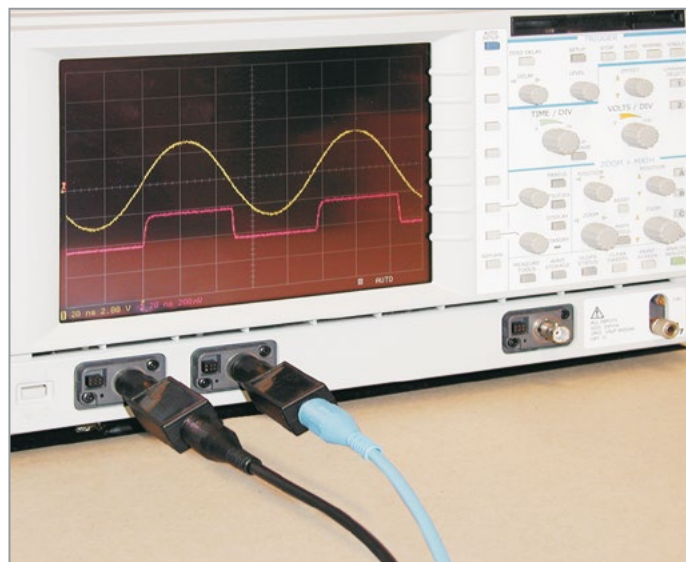

## BNC Box XBKS

Touch-protected empty BNC box for individual applications. The components in the box are connected by soldering. The BNC plug connectors allow these housings to be

easily inserted, e.g. by direct plugging into an oscilloscope input socket or as intermediate elements in BNC leads. The contact pins and sockets of the inner conductor of

the BNC plug connector are in gold-plated brass.

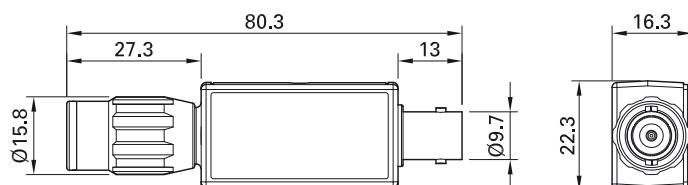

Order No.	Type	Rated voltage	Colour
67.9428	XBKS	Max. 300 V, CAT II <sup>1)</sup>	

<sup>1)</sup> Dependent on the component inserted.

## XFT-50 XFT-75

### Lead terminations with signal lead-through.

50 Ω - or 75 Ω lead terminations for the suppression of reflections. At the same time these permit high-impedance tapping of the signal.

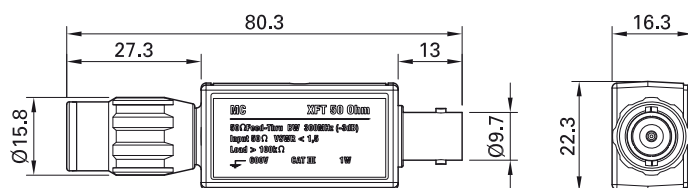

Order No.	Type	Input resistance		Colour
68.9898-21	XFT-50	50 Ω	Au Ni CE	21
68.9882-21	XFT-75	75 Ω	Au Ni CE	21

### Technical Data

Type	XFT-50	XFT-75
Rated voltage	600 V, CAT III	600 V, CAT III
Frequency range	0 ... 300 MHz	0 ... 150 MHz
VSWR (frequency-dependent) Typical values!		
Max. input power	1 W	1 W
Input resistance	50 Ω ± 1 %	75 Ω ± 1 %

## XIW-1 XIW-2

### Impedance transformers

Impedance transformers with broad-band transforming capacity for reflection-free interconnection of 50 Ω- and 75 Ω systems.

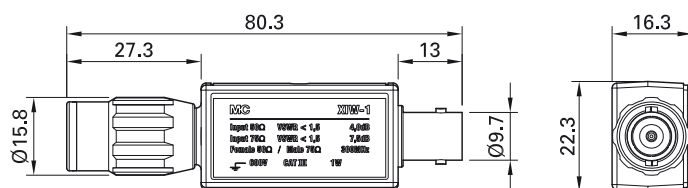

Order No.	Type	Input resistances		Colour
68.9884-21	XIW-1	75 Ω (male) / 50 Ω (female)	Au Ni CE	21
68.9885-21	XIW-2	50 Ω (male) / 75 Ω (female)	Au Ni CE	21

### Technical Data

Type	XIW-1	XIW-2
Rated voltage	600 V, CAT III	600 V, CAT III
Frequency range	0 ... 300 MHz	0 ... 300 MHz
VSWR 50	< 1.5	< 1.5
VSWR 75	< 1.5	< 1.5
Max. input power	1 W	1 W
Input resistances	75 Ω ± 1 % (male) / 50 Ω ± 1 % (female)	50 Ω ± 1 % (male) / 75 Ω ± 1 % (female)
Attenuation 50 Ω → 75 Ω	4 dB	4 dB
Attenuation 75 Ω → 50 Ω	7.5 dB	7.5 dB

XDG-3 XDG-6 XDG-10 XDG-20

**Attenuators**

Symmetrical attenuators on a 50 Ω basis for adaptation of signal levels. Particularly suited for situations that also place heavy

demands on the insulation of ground leads. Various attenuation values available.

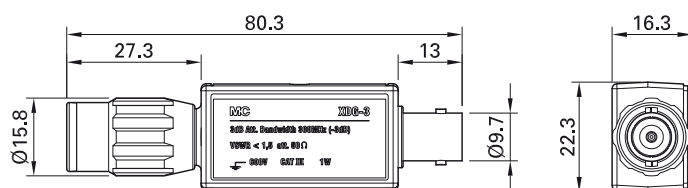

Order No.	Type	Attenuation		Colour
68.9886-21	XDG-3	3 dB	Au Ni CE	21
68.9887-21	XDG-6	6 dB	Au Ni CE	21
68.9888-21	XDG-10	10 dB	Au Ni CE	21
68.9889-21	XDG-20	20 dB	Au Ni CE	21

Technical Data				
Type	XDG-3	XDG-6	XDG-10	XDG-20
Rated voltage	600 V, CAT III	600 V, CAT III	600 V, CAT III	600 V, CAT III
Frequency range	0 ... 300 MHz	0 ... 300 MHz	0 ... 300 MHz	0 ... 300 MHz
Max. input power	1 W	1 W	1 W	1 W
Input resistance	50 Ω ± 1 %	50 Ω ± 1 %	50 Ω ± 1 %	50 Ω ± 1 %
VSWR	< 1.5	< 1.5	< 1.5	< 1.5
Attenuation	3 dB	6 dB	10 dB	20 dB
Accuracy (f = 150 MHz)	± 0.2 dB	± 0.2 dB	± 0.3 dB	± 0.3 dB
Accuracy (f = 300 MHz)	± 0.4 dB	± 0.4 dB	± 0.5 dB	± 0.5 dB

XFA-10:1/2 XFA-10:1/3 XFA-10:1/4 XFA-10:1

**Safety high voltage dividers**

Touch-protected 10:1 voltage divider. The voltage dividers are used to attenuate the test signal when simple test probes are

used. This combination is an economical solution that is of special interest to training establishments.

**Notice! When using these voltage dividers within mains circuits we recommend the use of test equipment with insulated input sockets.**

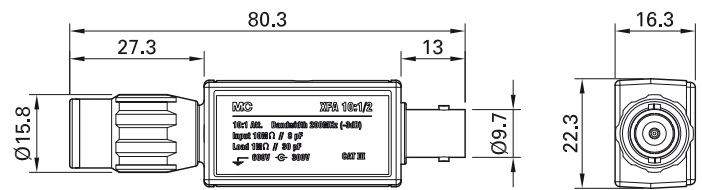

Order No.	Type		Colour
68.9895-21	XFA-10:1/2	Au Ni CE	21
68.9896-21	XFA-10:1/3	Au Ni CE	21
68.9897-21	XFA-10:1/4	Au Ni CE	21
68.9837-21	XFA-10:1	Au Ni CE	21

Technical Data				
Type	XFA-10:1/2	XFA-10:1/3	XFA-10:1/4	XFA-10:1
Rated voltage	Max. 300 V, CAT II			300 V, CAT II
Frequency range	0 ... 200 MHz	0 ... 200 MHz	0 ... 200 MHz	0 ... 4 kHz ± 5 %
Dividing ratio	10:1	10:1	10:1	10:1
Input capacitance	8 ± 1 pF	7.5 ± 1 pF	7.7 ± 1 pF	3.5 pF ± 1 pF
Input resistance	10 MΩ ± 1 %	10 MΩ ± 1 %	10 MΩ ± 1 %	10 MΩ ± 1 %
Nominal scope input impedance	1 MΩ    30 pF	1 MΩ    25 pF	1 MΩ    15 pF	1 MΩ    30 pF

## XOP-230

### Overvoltage protection

Protects voltage-sensitive measuring instruments from excessive voltages. Up to a threshold of approx. 230 V, the component

remains quiescent with a dividing ratio of approximately 1:1. If the input voltage exceeds a level of 230 V, the surge diversion

becomes active and the residual voltage at the output is approx. 100 V.

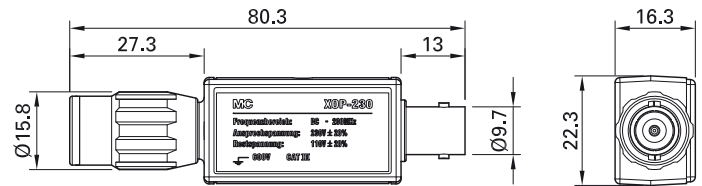

Order No.	Type		Colour
68.9883-21	XOP-230	Au Ni CE	21

Technical Data	
Type	XOP-230
Rated voltage	300 V, CAT II
Frequency range	0 ... 200 MHz
Dividing ratio	1:1
Input capacitance	Input capacitance of measuring instrument + ~ 4 pF
Input resistance	Input resistance of measuring instrument
Threshold voltage	230 V ± 20 %
Nominal oscilloscope input impedance	25 pF



# Technical Information

The casings of mains-powered oscilloscopes can become live with dangerous voltages, if, for instance, the protective conductor is interrupted. Persons carrying out measurements then run the risk of an electric shock on touching bare metal parts. In such cases, adequate protection from accidents is assured only with the use of touch-protected test equipment in association with touch-protected test accessories.

Touch-protected and at the same time shielded test accessories are also of in-

creasing importance because the EMC directive prescribes shielded leads for many applications.

For safe use in the high-frequency range, our passive oscilloscope probes of the Isoprobe series and the push-on accessories are rated for voltages to earth of up to max. 1000 V, CAT II, (Isoprobe II ) resp. 1000 V, CAT III / 600 V, CAT IV (Isoprobe III ) and are designed with clearance and creepage distances in accordance with the strict requirements of IEC / EN 61010-031.

The probes Isoprobe and their push-on accessories are designed for voltages up to a maximum of 1000 V<sub>r.m.s.</sub> between the internal conductor and shield – substantially higher than in conventional oscilloscope probes. This high dielectric strength allows high-frequency signals to be measured even when there is a direct mains connection.

In addition to our probes Isoprobe and the push-on accessories, with our BNC safety plug connectors we also supply a high-quality touch-protected BNC plug connection system to complete our safety high-frequency programme that is rated for voltages up to 1000 V, CAT II to earth and meets also the requirements of IEC / EN 61010-031.

This tried and tested BNC plug connector system has a long life of approximately 5000 connecting cycles. The shielded BNC test leads are highly flexible and are available with PVC and silicone insulation in a choice of colours.

All touch-protected BNC plug connectors are compatible with conventional BNC connectors. With such combinations, however, the 1000 V touch protection no longer applies to the whole system.

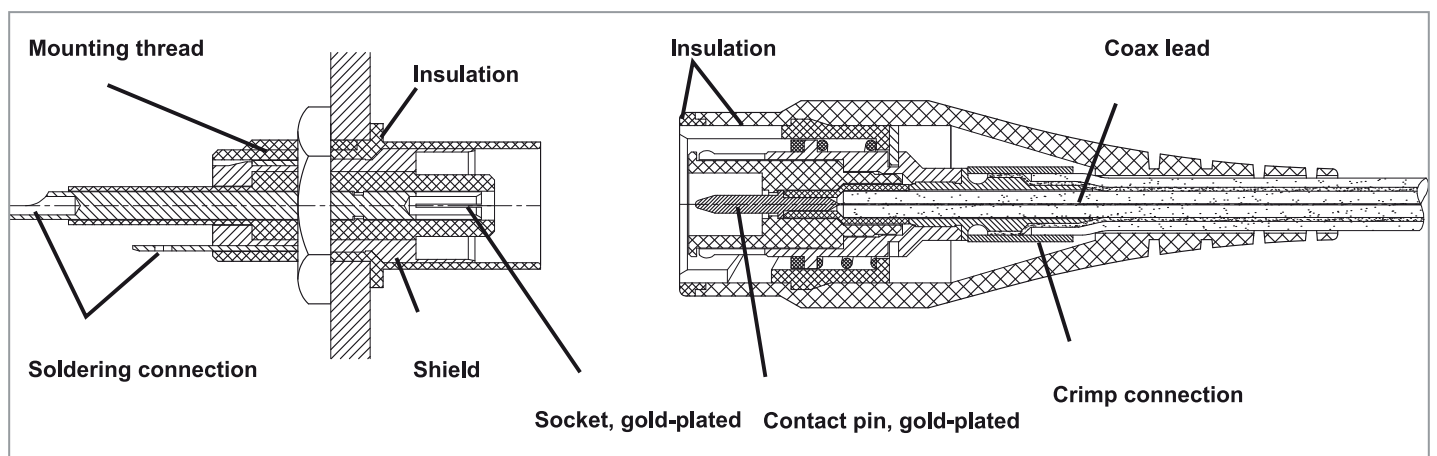

Test leads with touch-protected BNC plugs can be connected to devices with insulated and conventional BNC sockets.

As a result of the capacitive coupling between the shield and the "world outside" (e.g. a person touching the probe) the rated voltage shield/ground is frequency-dependent. As the frequency rises, the rated voltage falls until it approaches a lower

limit (left curve). The rated voltage inner conductor/shield falls exponentially with rising frequencies as a result of the capacitive properties of the probe and the limitation of the current due to the characteristics of the components (middle curve). The over-

all result is a fall in the rated voltage in accordance with the curve on the right. The curves in this example are for the test probe Isoprobe II - ECO.

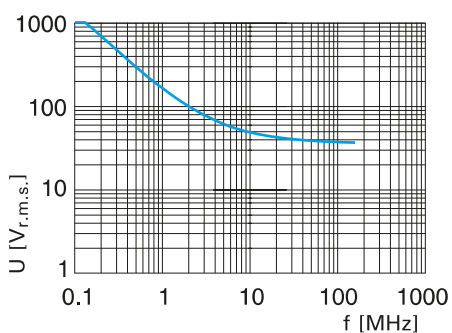

Voltage shield / earth

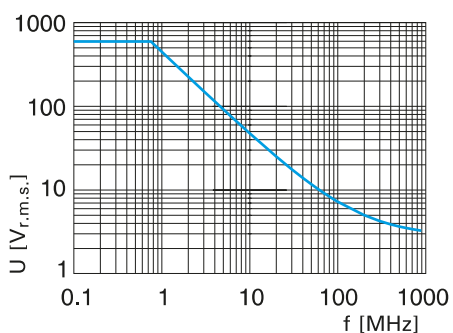

Voltage inner conductor / shield

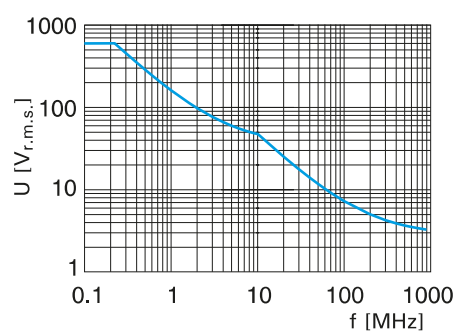

Rated voltage

## Probes – essential equipment for oscilloscopes

The oscilloscope is one of the most important test instruments in electronics. Constant development has substantially enhanced the performance of these devices and expanded their range of applications. In order to display a test signal on these

instruments, an electrical connection must be established between the oscilloscope and the object under test. The aim in establishing such a connection is to transmit the signal from the point of measurement to the oscilloscope with a minimum of dis-

tortion. Here, various factors must be taken into consideration which call for the use of special probes. Probe systems are broadly classified into passive and active types.

## Test conditions

### Input impedance

Every oscilloscope has an input impedance which may be high or low [50  $\Omega$ ]. In the case of a high-impedance oscilloscope, the input impedance consists of a real component, generally 1 M $\Omega$ , and a capacitive component of around 8 - 30 pF.

### Vertical scaling

The maximum vertical scaling of an oscilloscope is usually 10 V/div, which means that a maximum amplitude of 80 V<sub>ss</sub> can be displayed. For the measurement of larger voltage amplitudes, a voltage divider is required.

### Practicability

In electrical testing it is often necessary to quickly tap off signals from different points. In this situation, time-consuming plugged, soldered or screwed connections are not practicable.

### Outside interference

In order to eliminate outside interference, the system consisting of the probe and lead must be of coaxial design.

## Principle of a passive, high-impedance probe

The example shows a probe with a dividing ratio of 10:1. This enables signals up to  $800 V_{SS}$  to be visualised. As a result of the capacitive component of the scope's input

impedance and the capacity of the coaxial lead, it has the draw-back of a frequency dependence which must be compensated ( $C_v$  and  $C_{komp}$ ). The input impedance of

the probe is thus  $10 M\Omega \parallel C_{in}$ . In probes of this type a typical value for  $C_{in}$  is around 10 - 15 pF (including stray capacities).

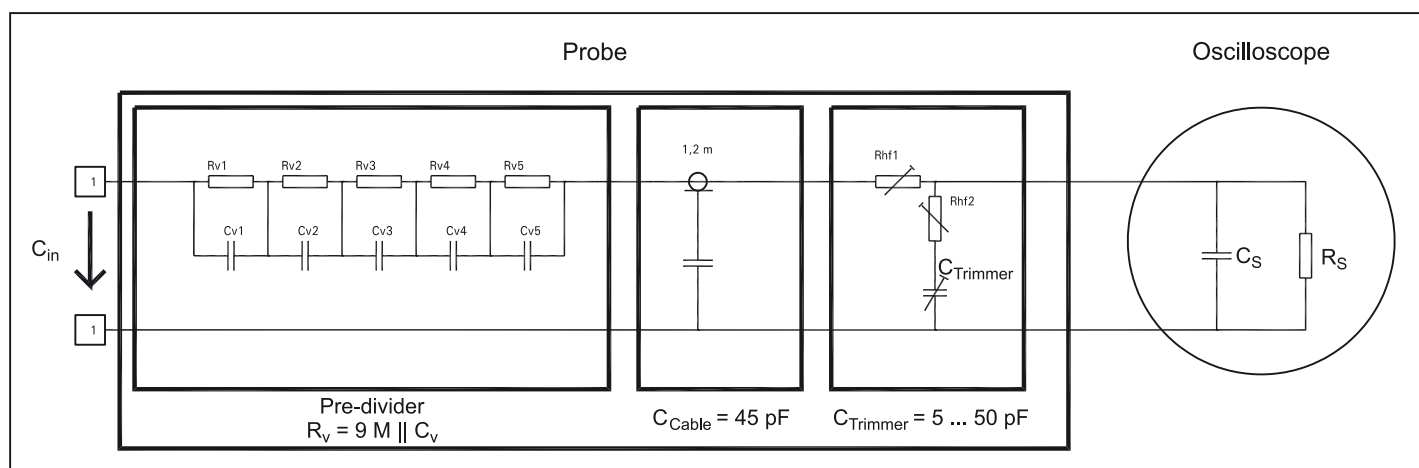

**Schematic diagram of a passive 10:1 test probe**

## Limits to the use of passive probes

Today there are many suppliers of passive probes with bandwidths of up to 500 MHz. When using these probes at frequencies above 20 MHz, however, one should bear in mind the influence exerted on the test object by their input impedance.

At a frequency of 100 MHz, the passive probe shown in the example has an impedance of only 100 - 150  $\Omega$ . This already causes distortion of a signal from a 50  $\Omega$ -source. In order to reduce this distortion, the capacities of the coaxial lead and the scope

must be reduced. This is virtually impossible. However, there is another solution: an impedance converter needs to be installed directly after the divider in order to decouple it from the following components. In this situation an active probe may be a help.

# Index

Type	Page
AB200	39
AC200	37
BA400	11
BST-45	53
GB200	40
GB284	40
GH200	39
GH284	39
GM200	40
GM200-F	40
GM284	40
GM400	11
GS400	11, 38
HC200	37
HC400	11
Isoprobe II – 1:1	12
Isoprobe II – 10:1 – 2,5	20
Isoprobe II – 10:1 ECO	14
Isoprobe II – 10:1 HF	16
Isoprobe II – 10:1 HS	18
Isoprobe II – 100:1	22
Isoprobe III – 10:1 – 2,5	30
Isoprobe III – 10:1 ECO	24
Isoprobe III – 10:1 HF	26
Isoprobe III – 10:1 HS	28
Isoprobe III – 100:1	32
Isoprobe III – HP	35
Isoprobe IV - 10:1	8
Isoprobe IV – 100:1	9
PB200	38
PT200	38
SCC	40
SET Isoprobe II - 1:1	13
SET Isoprobe II – 10:1 – 2,5	21
SET Isoprobe II – 10:1 ECO	15
SET Isoprobe II – 10:1 HF	17
SET Isoprobe II – 10:1 HS	19
SET Isoprobe II – 100:1	23
SET Isoprobe III – 10:1 – 2,5	31
SET Isoprobe III – 10:1 ECO	25
SET Isoprobe III – 10:1 HF	27
SET Isoprobe III – 10:1 HS	29
SET Isoprobe III – 100:1	33
SET Isoprobe III – HP	36

Type	Page
SET Isoprobe IV – 10:1	10
SET Isoprobe IV – 100:1	10
SK-IP	39
XBB-C58	46
XBB-L	47
XBB-LL	47
XBB-P	48
XBB-PL	48
XBH-200	50
XBK-58	45
XBKS	59
XBS-58	45
XBWB-P	49
XDG-3	62
XDG-6	62
XDG-10	62
XDG-20	62
XDS-BS/58	55
XDS-BS/SIL	55
XFA-10:1	63
XFA-10:1/2	63
XFA-10:1/3	63
XFA-10:1/4	63
XF-BB/4	51
XF-F	57
XF-SS/4	51
XFT-50	60
XFT-75	60
XIW-1	61
XIW-2	61
XLAM-205L	56
XLAM-414/SC	52
XLAM-414/SC/SIL	52
XLAM-446/SC	54
XLAM-446/SC/SIL	54
XLAM-H200	50
XLSK-58	41
XLSS-58	41
XLSS-174	42
XLSS/SIL	43
XLWW-58	44
XLWW/SIL	44
XM-B	51
XM-BB/4	51

Type	Page
XM-FF	58
XM-M	57
XM-MM	58
XM-SS/4	51
XOP-230	64
XTBA	38
ZGA	37
ZGA-S	37



■ Stäubli Units    ○ Agents

# Global presence of the Stäubli Group

[www.staubli.com/contacts](http://www.staubli.com/contacts)



## X-ON Electronics

Largest Supplier of Electrical and Electronic Components

*Click to view similar products for [Test Clips](#) category:*

*Click to view products by [STAUBLI](#) manufacturer:*

Other Similar products are found below :

[010000](#) [923743-16](#) [923850-C](#) [BU-656-0](#) [4140A](#) [4324A](#) [TL820](#) [TL822](#) [5116](#) [5450](#) [5216](#) [5252](#) [5454](#) [5694](#) [923700](#) [923698](#) [CR0060](#) [3038](#)  
[927739-20](#) [923743-14](#) [923743-40](#) [932146101](#) [930318100](#) [930126101](#) [R999701600](#) [Z-S11F0107G1000](#) [Z-S11F0207B1520](#) [Z-](#)  
[S11F0207B15000](#) [Z-SB3FA3226AAAB11001](#) [Z-S11F0207B1010](#) [Z-S11F0207B3000](#) [923706](#) [930317800](#) [930317801](#) [973889100](#)  
[972405100](#) [972405101](#) [923714](#) [R999720600](#) [949-1](#) [458-3](#) [SK 201200278 020](#) [BU-65-B](#) [BU-21CPN-GZZZ](#) [PK-HVA-02](#) [BU-25C-DZZZ](#)  
[BU-142-2](#) [BU-128-0](#) [BU-127](#) [SAK 6675 NI / GNGE](#)