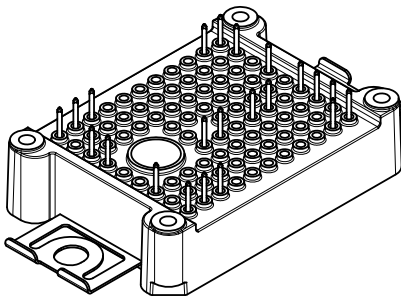
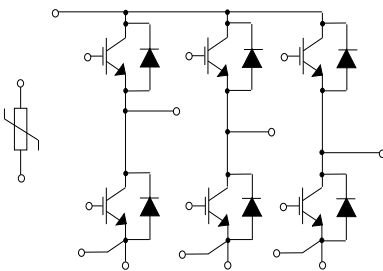

## ACEPACK™ 1 sixpack topology, 1200 V, 35 A, trench gate field-stop M series IGBT with soft diode and NTC

**ACEPACK™ 1**

### Features

- ACEPACK™ 1 power module
  - DBC Cu Al<sub>2</sub>O<sub>3</sub> Cu
- Sixpack topology
  - 1200 V, 35 A IGBTs and diodes
  - Soft and fast recovery diode
- Integrated NTC

### Applications

- Inverters
- Industrial
- Motor drives

### Description

This power module is a sixpack topology in an ACEPACK™ 1 package with NTC, integrating the advanced trench gate field-stop technologies from STMicroelectronics. This new IGBT technology represents the best compromise between conduction and switching loss, to maximize the efficiency of any converter system up to 20 kHz.



#### Product status

A1P35S12M3

#### Product summary

<b>Order code</b>	A1P35S12M3
<b>Marking</b>	A1P35S12M3
<b>Package</b>	ACEPACK™ 1
<b>Leads type</b>	Solder contact pins

# 1 Electrical ratings

## 1.1 IGBT

Limiting values at  $T_J = 25\text{ °C}$ , unless otherwise specified.

**Table 1. Absolute maximum ratings of the IGBT**

Symbol	Parameter	Value	Unit
$V_{CES}$	Collector-emitter voltage ( $V_{GE} = 0\text{ V}$ )	1200	V
$I_C$	Continuous collector current ( $T_C = 100\text{ °C}$ )	35	A
$I_{CP}^{(1)}$	Pulsed collector current ( $t_p = 1\text{ ms}$ )	70	A
$V_{GE}$	Gate-emitter voltage	$\pm 20$	V
$P_{TOT}$	Total power dissipation of each IGBT ( $T_C = 25\text{ °C}$ , $T_J = 175\text{ °C}$ )	250	W
$T_{JMAX}$	Maximum junction temperature	175	$^{\circ}\text{C}$
$T_{Jop}$	Operating junction temperature range under switching conditions	-40 to 150	$^{\circ}\text{C}$

1. Pulse width limited by maximum junction temperature.

**Table 2. Electrical characteristics of the IGBT**

Symbol	Parameter	Test conditions	Min.	Typ.	Max.	Unit
$V_{(BR)CES}$	Collector-emitter breakdown voltage	$I_C = 1\text{ mA}$ , $V_{GE} = 0\text{ V}$	1200			V
$V_{CE(sat)}$ (terminal)	Collector-emitter saturation voltage	$V_{GE} = 15\text{ V}$ , $I_C = 35\text{ A}$ $V_{GE} = 15\text{ V}$ , $I_C = 35\text{ A}$ , $T_J = 150\text{ °C}$		1.95 2.3	2.45	V
$V_{GE(th)}$	Gate threshold voltage	$V_{CE} = V_{GE}$ , $I_C = 1\text{ mA}$	5	6	7	V
$I_{CES}$	Collector cut-off current	$V_{GE} = 0\text{ V}$ , $V_{CE} = 1200\text{ V}$			100	$\mu\text{A}$
$I_{GES}$	Gate-emitter leakage current	$V_{CE} = 0\text{ V}$ , $V_{GE} = \pm 20\text{ V}$			$\pm 500$	nA
$C_{ies}$	Input capacitance	$V_{CE} = 25\text{ V}$ , $f = 1\text{ MHz}$ , $V_{GE} = 0\text{ V}$		2154		pF
$C_{oes}$	Output capacitance			164		pF
$C_{res}$	Reverse transfer capacitance			86		pF
$Q_g$	Total gate charge	$V_{CC} = 960\text{ V}$ , $I_C = 35\text{ A}$ , $V_{GE} = \pm 15\text{ V}$		163		nC
$t_{d(on)}$	Turn-on delay time	$V_{CC} = 600\text{ V}$ , $I_C = 35\text{ A}$ , $R_G = 10\text{ }\Omega$ , $V_{GE} = \pm 15\text{ V}$ ,		122		ns
$t_r$	Current rise time			17		ns
$E_{on}^{(1)}$	Turn-on switching energy	$di/dt = 1900\text{ A}/\mu\text{s}$		1.21		mJ
$t_{d(off)}$	Turn-off delay time	$V_{CC} = 600\text{ V}$ , $I_C = 35\text{ A}$ , $R_G = 10\text{ }\Omega$ , $V_{GE} = \pm 15\text{ V}$ ,		142		ns
$t_f$	Current fall time			150		ns
$E_{off}^{(2)}$	Turn-off switching energy		$dv/dt = 7800\text{ V}/\mu\text{s}$		2.19	

Symbol	Parameter	Test conditions	Min.	Typ.	Max.	Unit
$t_{d(on)}$	Turn-on delay time	$V_{CC} = 600\text{ V}$ , $I_C = 35\text{ A}$ , $R_G = 10\ \Omega$ , $V_{GE} = \pm 15\text{ V}$ , $di/dt = 1533\text{ A}/\mu\text{s}$ , $T_J = 150\text{ }^\circ\text{C}$		124		ns
$t_r$	Current rise time			18		ns
$E_{on(1)}$	Turn-on switching energy				1.8	
$t_{d(off)}$	Turn-off delay time	$V_{CC} = 600\text{ V}$ , $I_C = 35\text{ A}$ , $R_G = 10\ \Omega$ , $V_{GE} = \pm 15\text{ V}$ , $dv/dt = 6700\text{ V}/\mu\text{s}$ , $T_J = 150\text{ }^\circ\text{C}$		142		ns
$t_f$	Current fall time			256		ns
$E_{off(2)}$	Turn-off switching energy				3.1	
$t_{SC}$	Short-circuit withstand time	$V_{CC} \leq 600\text{ V}$ , $V_{GE} \leq 15\text{ V}$ , $T_{Jstart} \leq 150\text{ }^\circ\text{C}$	10			$\mu\text{s}$
$R_{THj-c}$	Thermal resistance junction-to-case	Each IGBT		0.55	0.60	$^\circ\text{C}/\text{W}$
$R_{THc-h}$	Thermal resistance case-to- heatsink	Each IGBT, $\lambda_{grease} = 1\text{ W}/(\text{m}\cdot^\circ\text{C})$		0.70		$^\circ\text{C}/\text{W}$

1. Including the reverse recovery of the diode.
2. Including the tail of the collector current.

## 1.2 Diode

Limiting values at  $T_J = 25\text{ }^\circ\text{C}$ , unless otherwise specified.

**Table 3. Absolute maximum ratings of the diode**

Symbol	Parameter	Value	Unit
$V_{RRM}$	Repetitive peak reverse voltage	1200	V
$I_F$	Continuous forward current at $T_C = 100\text{ }^\circ\text{C}$	35	A
$I_{FP(1)}$	Pulsed forward current ( $t_p = 1\text{ ms}$ )	70	A
$T_{JMAX}$	Maximum junction temperature	175	$^\circ\text{C}$
$T_{Jop}$	Operating junction temperature range under switching conditions	-40 to 150	$^\circ\text{C}$

1. Pulse width limited by maximum junction temperature.

**Table 4. Electrical characteristics of the diode**

Symbol	Parameter	Test conditions	Min.	Typ.	Max.	Unit
$V_F$ (terminal)	Forward voltage	$I_F = 35\text{ A}$	-	2.95	4.1	V
		$I_F = 35\text{ A}$ , $T_J = 150\text{ }^\circ\text{C}$	-	2.3		
$t_{rr}$	Reverse recovery time	$I_F = 35\text{ A}$ , $V_R = 600\text{ V}$ , $V_{GE} = \pm 15\text{ V}$ , $di/dt = 1900\text{ A}/\mu\text{s}$	-	140		ns
$Q_{rr}$	Reverse recovery charge		-	2.62		$\mu\text{C}$
$I_{rrm}$	Reverse recovery current		-	54		A
$E_{rec}$	Reverse recovery energy		-	1.2		mJ

Symbol	Parameter	Test conditions	Min.	Typ.	Max.	Unit
$t_{rr}$	Reverse recovery time	$I_F = 35\text{ A}$ , $V_R = 600\text{ V}$ , $V_{GE} = \pm 15\text{ V}$ , $di/dt = 1533\text{ A}/\mu\text{s}$ , $T_J = 150\text{ }^\circ\text{C}$	-	350		ns
$Q_{rr}$	Reverse recovery charge		-	6.6		$\mu\text{C}$
$I_{rrm}$	Reverse recovery current		-	63		A
$E_{rec}$	Reverse recovery energy		-	3.2		mJ
$R_{THj-c}$	Thermal resistance junction-to-case	Each diode	-	0.8	0.9	$^\circ\text{C}/\text{W}$
$R_{THc-h}$	Thermal resistance case-to-heatsink	Each diode, $\lambda_{grease} = 1\text{ W}/(\text{m}\cdot^\circ\text{C})$	-	0.75		$^\circ\text{C}/\text{W}$

**1.3**
**NTC**
**Table 5. NTC temperature sensor, considered as stand-alone**

Symbol	Parameter	Test conditions	Min.	Typ.	Max.	Unit
$R_{25}$	Resistance	$T = 25^\circ\text{C}$		5		$\text{k}\Omega$
$R_{100}$	Resistance	$T = 100^\circ\text{C}$		493		$\Omega$
$\Delta R/R$	Deviation of $R_{100}$		-5		+5	%
$B_{25/50}$	B-constant			3375		K
$B_{25/80}$	B-constant			3411		K
T	Operating temperature range		-40		150	$^\circ\text{C}$

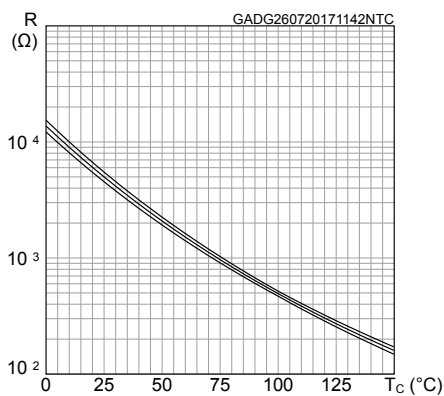
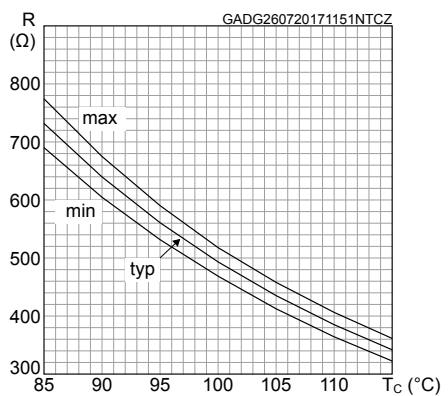
**Figure 1. NTC resistance vs temperature**

**Figure 2. NTC resistance vs temperature, zoom**

## 1.4 Package

**Table 6. ACEPACK™ 1 package**

Symbol	Parameter	Min.	Typ.	Max.	Unit
$V_{\text{isol}}$	Isolation voltage (AC voltage, $t = 60$ s)			2500	Vrms
$T_{\text{stg}}$	Storage temperature	-40		125	°C
CTI	Comparative tracking index	200			
$L_s$	Stray inductance module P1 - EW loop		28.7		nH
$R_s$	Module single lead resistance, terminal-to-chip		3.9		mΩ

## 2 Electrical characteristics (curves)

Figure 3. IGBT output characteristics ( $V_{GE} = 15V$ , terminal)

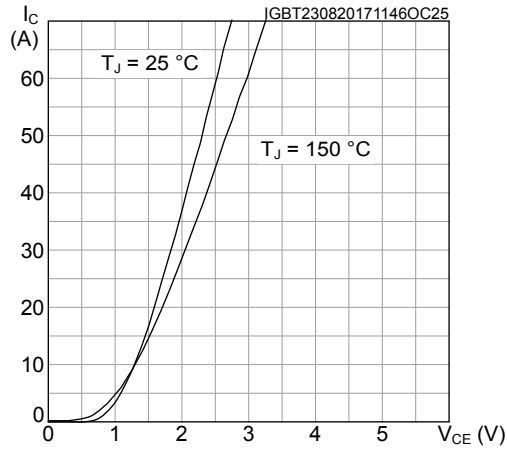

Figure 4. IGBT output characteristics ( $T_J = 150\text{ °C}$ , terminal)

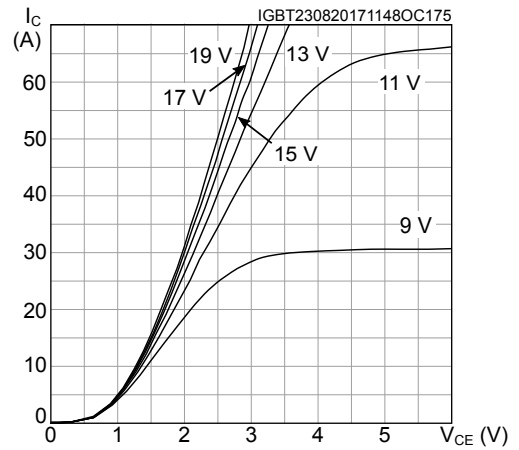

Figure 5. IGBT transfer characteristics ( $V_{CE} = 15V$ , terminal)

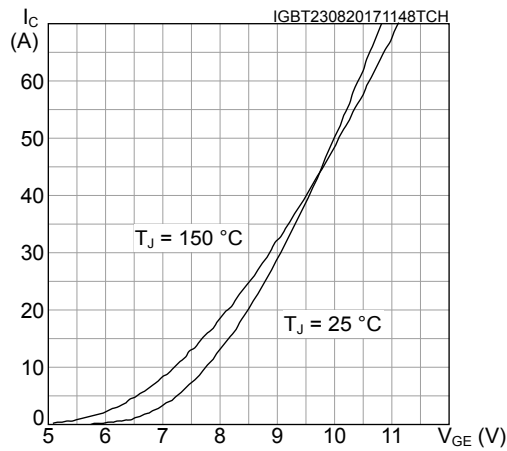

Figure 6. IGBT collector current vs case temperature

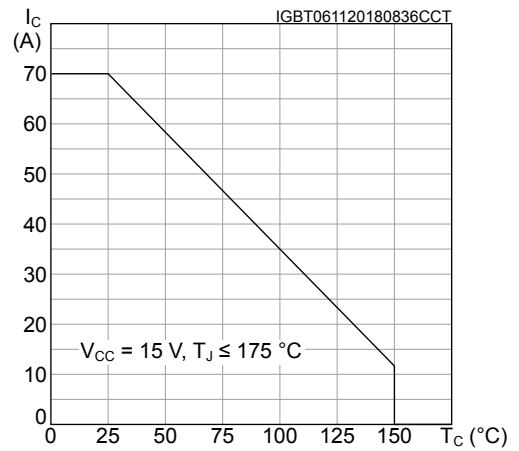

Figure 7. Switching energy vs gate resistance

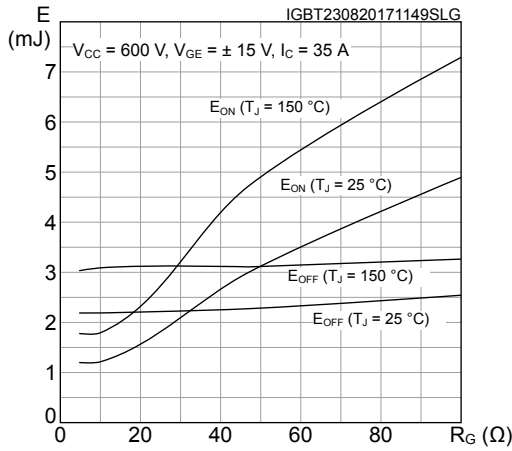

Figure 8. Switching energy vs collector current

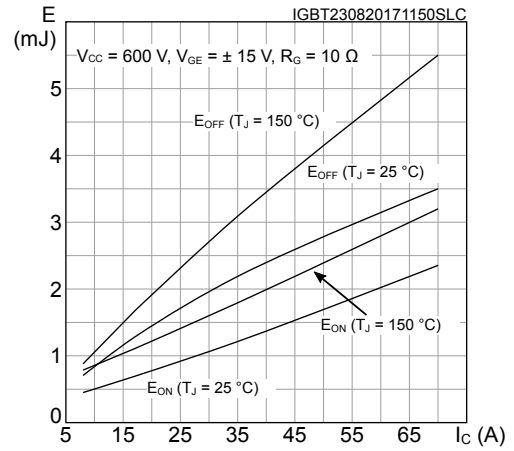

Figure 9. IGBT reverse biased safe operating area (RBSOA)

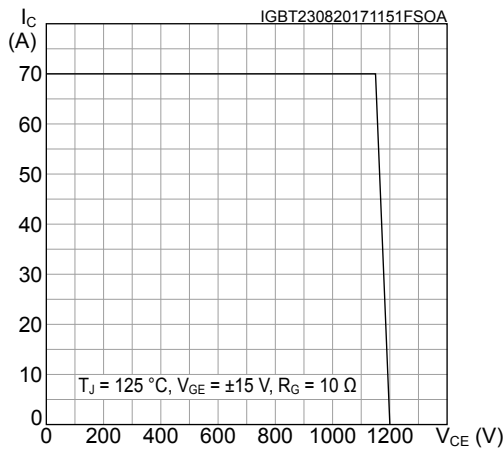

Figure 10. Diode forward characteristics (terminal)

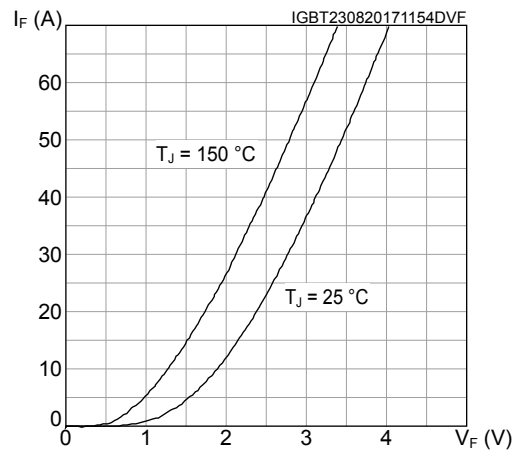

Figure 11. Diode reverse recovery energy vs diode current slope

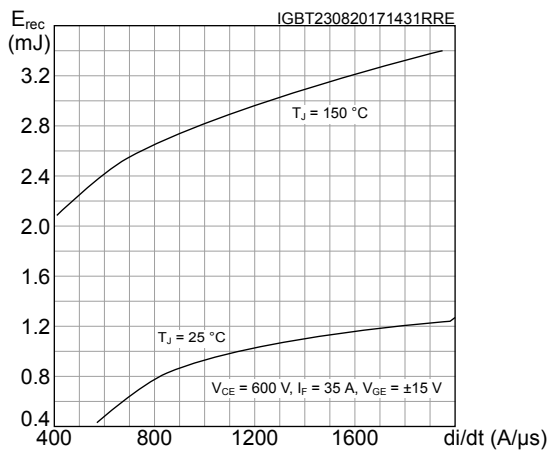

Figure 12. Diode reverse recovery energy vs forward current

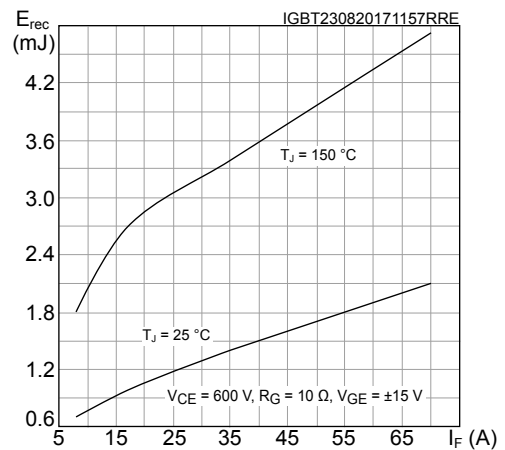

Figure 13. Diode reverse recovery energy vs gate resistance

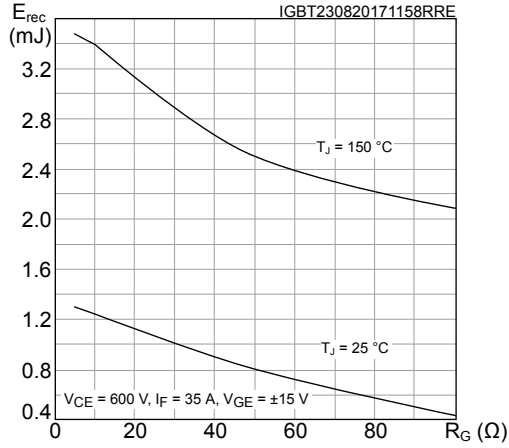

Figure 14. Inverter diode thermal impedance

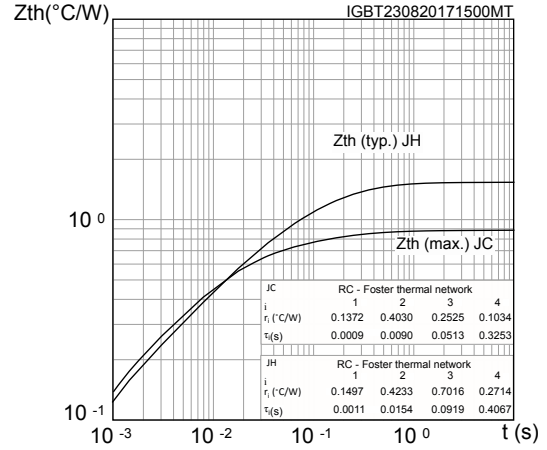
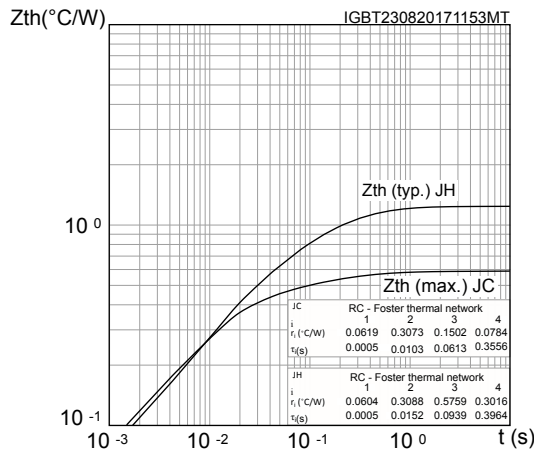

Figure 15. IGBT thermal impedance







## 4 Topology and pin description

Figure 20. Electrical topology and pin description

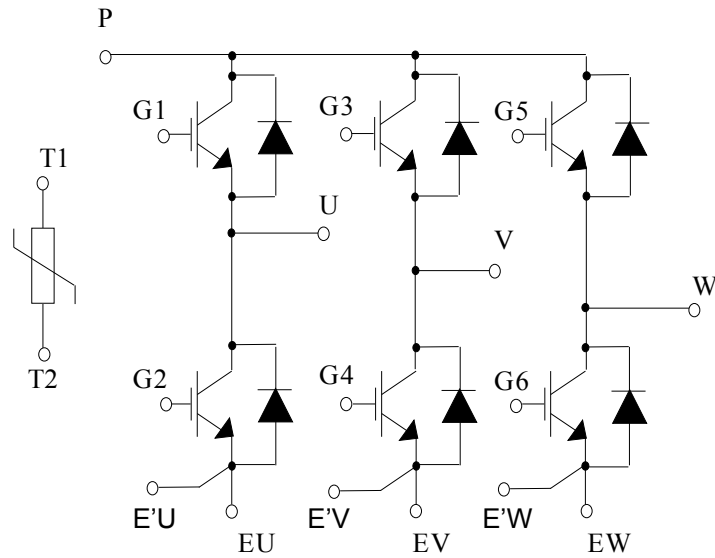
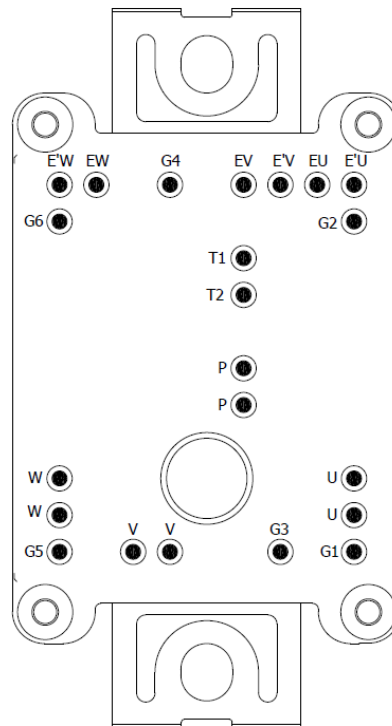

Figure 21. Package top view with sixpack pinout



## **5** Package information

---

In order to meet environmental requirements, ST offers these devices in different grades of **ECOPACK®** packages, depending on their level of environmental compliance. ECOPACK® specifications, grade definitions and product status are available at: [www.st.com](http://www.st.com). ECOPACK® is an ST trademark.

## 5.1 ACEPACK™ 1 sixpack solder pins package information

Figure 22. ACEPACK™ 1 sixpack solder pins package outline (dimensions are in mm)

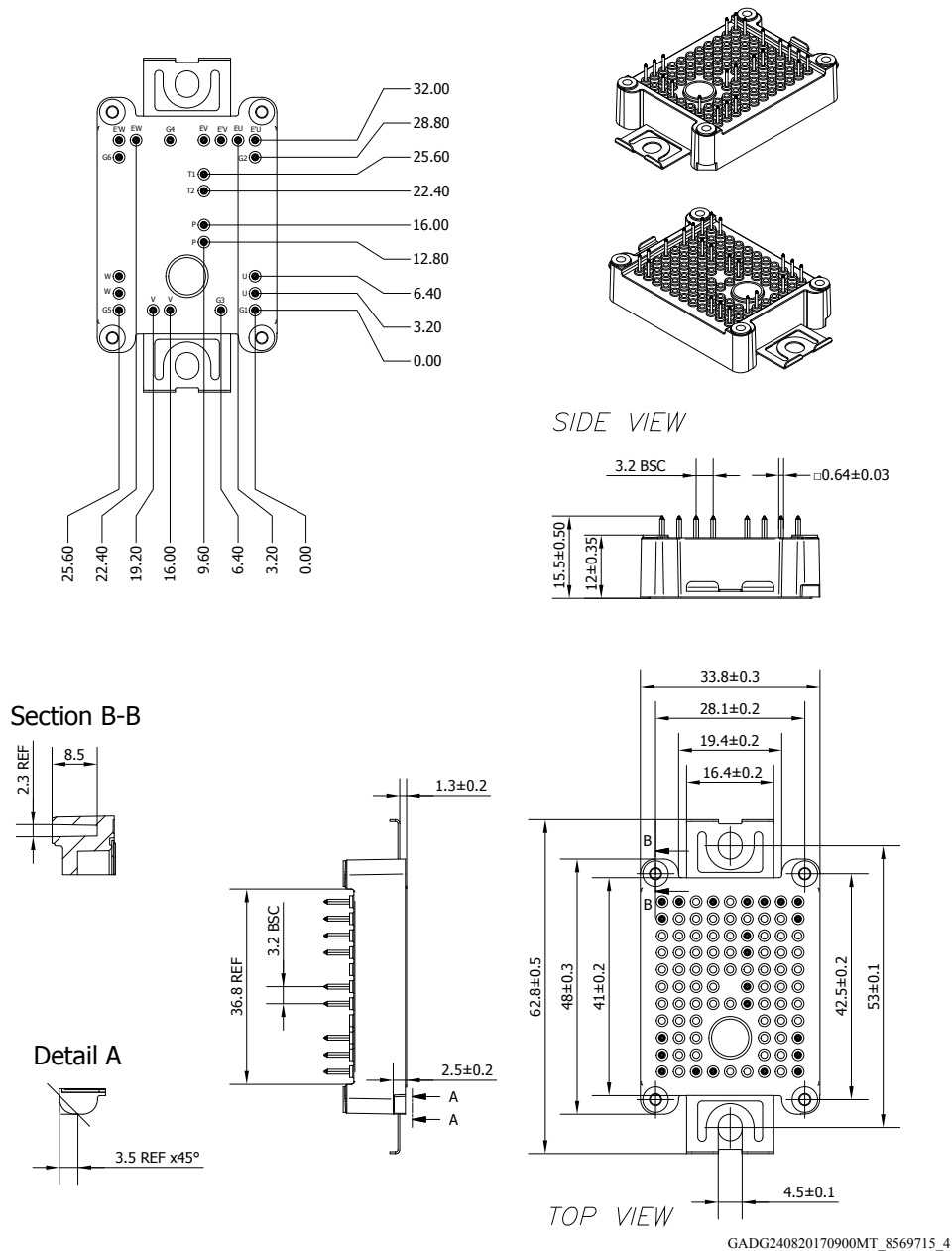

- The lead size includes the thickness of the lead plating material.
- Dimensions do not include mold protrusion.
- Package dimensions do not include any eventual metal burrs.

## Revision history

**Table 7. Document revision history**

Date	Revision	Changes
02-May-2016	1	Initial release.
24-Aug-2017	2	Updated title, features, description and <i>Table 1: "Device summary"</i> in cover page. Updated <i>Section 1: "Electrical ratings"</i> . Added <i>Section 2: "Electrical characteristics curves"</i> , <i>Section 3: "Test circuits"</i> , <i>Section 4: "Topology and pin description"</i> and <i>Section 5: "Package information"</i> . Minor text changes.
02-Oct-2017	3	Document status promoted from preliminary data to production data. Updated <i>Table 7: "ACEPACK™ 1 package"</i> and <i>Section 2: "Electrical characteristics curves"</i> . Minor text changes.
16-Feb-2018	4	Updated features and removed maturity status indication from cover page. Updated <i>Figure 13. Inverter diode thermal impedance</i> and <i>Figure 14. IGBT thermal impedance</i> . Updated <i>Figure 21. ACEPACK™ 1 sixpack solder pins package outline (dimensions are in mm)</i> . Minor text changes
14-Nov-2018	5	Added <a href="#">Figure 6. IGBT collector current vs case temperature</a> . Minor text changes

## Contents

<b>1</b>	<b>Electrical ratings</b> .....	<b>2</b>
1.1	IGBT .....	2
1.2	Diode .....	3
1.3	NTC.....	4
1.4	Package .....	5
<b>2</b>	<b>Electrical characteristics (curves)</b> .....	<b>6</b>
<b>3</b>	<b>Test circuits</b> .....	<b>9</b>
<b>4</b>	<b>Topology and pin description</b> .....	<b>10</b>
<b>5</b>	<b>Package information</b> .....	<b>11</b>
5.1	ACEPACK™ 1 sixpack solder pins package information .....	12
	<b>Revision history</b> .....	<b>13</b>

**IMPORTANT NOTICE – PLEASE READ CAREFULLY**

STMicroelectronics NV and its subsidiaries (“ST”) reserve the right to make changes, corrections, enhancements, modifications, and improvements to ST products and/or to this document at any time without notice. Purchasers should obtain the latest relevant information on ST products before placing orders. ST products are sold pursuant to ST’s terms and conditions of sale in place at the time of order acknowledgement.

Purchasers are solely responsible for the choice, selection, and use of ST products and ST assumes no liability for application assistance or the design of Purchasers’ products.

No license, express or implied, to any intellectual property right is granted by ST herein.

Resale of ST products with provisions different from the information set forth herein shall void any warranty granted by ST for such product.

ST and the ST logo are trademarks of ST. All other product or service names are the property of their respective owners.

Information in this document supersedes and replaces information previously supplied in any prior versions of this document.

© 2018 STMicroelectronics – All rights reserved

## X-ON Electronics

Largest Supplier of Electrical and Electronic Components

*Click to view similar products for [IGBT Modules category](#):*

*Click to view products by [STMicroelectronics manufacturer](#):*

Other Similar products are found below :

[F3L400R07ME4\\_B22](#) [F4-50R07W2H3\\_B51](#) [FB15R06W1E3](#) [FB20R06W1E3\\_B11](#) [FD1000R33HE3-K](#) [FD400R12KE3](#) [FD400R33KF2C-K](#)  
[FD401R17KF6C\\_B2](#) [FD-DF80R12W1H3\\_B52](#) [FF200R06YE3](#) [FF300R12KE4\\_E](#) [FF450R12ME4P](#) [FF600R12IP4V](#) [FP15R12W2T4](#)  
[FP20R06W1E3](#) [FP50R12KT3](#) [FP75R07N2E4\\_B11](#) [FS10R12YE3](#) [FS150R07PE4](#) [FS150R12PT4](#) [FS200R12KT4R](#) [FS20R06W1E3\\_B11](#)  
[FS50R07N2E4\\_B11](#) [FZ1000R33HE3](#) [FZ1800R17KF4](#) [DD250S65K3](#) [DF1000R17IE4](#) [DF1000R17IE4D\\_B2](#) [DF1400R12IP4D](#)  
[DF200R12PT4\\_B6](#) [DF400R07PE4R\\_B6](#) [BSM75GB120DN2\\_E3223c-Se](#) [F3L300R12ME4\\_B22](#) [F3L75R07W2E3\\_B11](#) [F4-50R12KS4\\_B11](#)  
[F475R07W1H3B11ABOMA1](#) [FD1400R12IP4D](#) [FD200R12PT4\\_B6](#) [FD800R33KF2C-K](#) [FF150R12ME3G](#) [FF300R17KE3\\_S4](#)  
[FF300R17ME4\\_B11](#) [FF401R17KF6C\\_B2](#) [FF650R17IE4D\\_B2](#) [FF900R12IP4D](#) [FF900R12IP4DV](#) [FP50R07N2E4\\_B11](#) [FS100R07PE4](#)  
[FS150R07N3E4\\_B11](#) [FS150R17N3E4](#)