



ACS110-7SN/SB2

ASD™ AC Switch Family

AC LINE SWITCH

MAIN APPLICATIONS

- AC static switching in appliance control systems
- Drive of low power high inductive or resistive loads like
 - relay, valve, solenoid, dispenser
 - pump, fan, micro-motor
 - defrost heater

FEATURES

- Blocking voltage : $V_{DRM} / V_{RRM} = +/-700V$
- Avalanche controlled : $V_{CL\ typ} = 1100\ V$
- Nominal conducting current : $I_{T(RMS)} = 1A$
- Gate triggering current : $I_{GT} < 10\ mA$
- Switch integrated driver
- High noise immunity : static $dV/dt > 500V/\mu s$

BENEFITS

- No external protection snubber or varistor needed
- Enables equipment to meet IEC 61000-4-5 & IEC 335-1 (DIL-8 package)
- Reduces component count up to 80 %
- Interfaces directly with the microcontroller
- Eliminates any gate kick back on the microcontroller
- Allows straightforward connection of several ACS™ on same cooling pad (SOT-223)

DESCRIPTION

The ACS110 belongs to the AC line switch family built around the ASD™ concept. This high performance switch circuit is able to control a load up to 1 A.

The ACS™ switch embeds a high voltage clamping structure to absorb the inductive turn off energy and a gate level shifter driver to separate the digital controller from the main switch. It is triggered with a negative gate current flowing out of the gate pin.

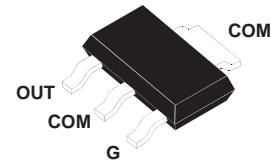

SOT-223
ACS110-7SN

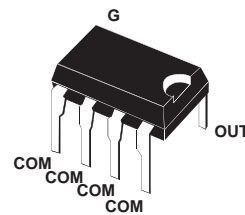

DIL-8
ACS110-7SB2

FUNCTIONAL DIAGRAM

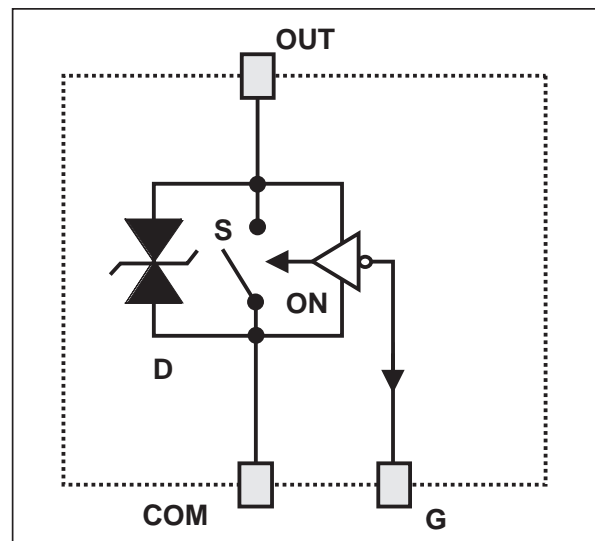

ACS110-7SN/SB2

ABSOLUTE RATINGS (limiting values)

For either positive or negative polarity of pin OUT voltage in respect to pin COM voltage

Symbol	Parameter		Value	Unit	
V_{DRM} / V_{RRM}	Repetitive peak off-state voltage		$T_j = -10\text{ °C}$	700	V
$I_{T(RMS)}$	RMS on-state current full cycle sine wave 50 to 60 Hz	SOT-223	$T_{tab} = 105\text{ °C}$	1	A
		DIL-8	$T_{lead} = 110\text{ °C}$		
I_{TSM}	Non repetitive surge peak on-state current T_j initial = 25 °C , full cycle sine wave		F = 50 Hz	8	A
			F = 60 Hz	11	A
I^2t	Fusing capability		$t_p = 10\text{ms}$	0.35	A^2s
di/dt	Repetitive on-state current critical rate of rise $I_G = 10\text{mA}$ ($t_r < 100\text{ns}$)	$T_j = 125\text{ °C}$	F = 120 Hz	50	$A/\mu s$
V_{PP}	Non repetitive line peak pulse voltage		note 1	2	kV
T_{stg}	Storage temperature range			- 40 to + 150	$^{\circ}\text{C}$
T_j	Operating junction temperature range			- 30 to + 125	$^{\circ}\text{C}$
T_l	Maximum lead soldering temperature during 10s			260	$^{\circ}\text{C}$

Note 1: according to test described by IEC61000-4-5 standard & Figure 3.

GATE CHARACTERISTICS (maximum values)

Symbol	Parameter	Value	Unit
$P_{G(AV)}$	Average gate power dissipation	0.1	W
I_{GM}	Peak gate current ($t_p = 20\mu s$)	1	A
V_{GM}	Peak positive gate voltage (in respect to pin COM)	5	V

THERMAL RESISTANCES

Symbol	Parameter	Value	Unit	
$R_{th(j-a)}$	Junction to ambient $S = 5\text{cm}^2$	SOT-223	60	$^{\circ}\text{C/W}$
		DIL-8	60	$^{\circ}\text{C/W}$
$R_{th(j-l)}$	Junction to tab/lead for full cycle sine wave conduction	SOT-223	20	$^{\circ}\text{C/W}$
		DIL-8	15	$^{\circ}\text{C/W}$

S = Copper surface under Tab

PARAMETER DESCRIPTION

Parameter Symbol	Parameter description
I_{GT}	Triggering gate current
V_{GT}	Triggering gate voltage
V_{GD}	Non-triggering gate voltage
I_H	Holding current
I_L	Latching current
V_{TM}	Peak on-state voltage drop
V_{TO}	On state threshold voltage
R_d	On state dynamic resistance
I_{DRM} / I_{RRM}	Maximum forward or reverse leakage current
dV/dt	Critical rate of rise of off-state voltage
$(dV/dt)_c$	Critical rate of rise of commutating off-state voltage
$(dI/dt)_c$	Critical rate of decrease of commutating on-state current
V_{CL}	Clamping voltage
I_{CL}	Clamping current

ELECTRICAL CHARACTERISTICS

For either positive or negative polarity of pin OUT voltage respect to pin COM voltage excepted note 3*.

Symbol	Test Conditions	Values	Unit	
I_{GT}	$V_{OUT}=12V$ (DC) $R_L=140\Omega$ QII - QIII $T_j=25^\circ C$	MAX	10 mA	
V_{GT}	$V_{OUT}=12V$ (DC) $R_L=140\Omega$ QII - QIII $T_j=25^\circ C$	MAX	1 V	
V_{GD}	$V_{OUT}=V_{DRM}$ $R_L=3.3k\Omega$ $T_j=125^\circ C$	MIN	0.15 V	
I_H	$I_{OUT}=100mA$ gate open $T_j=25^\circ C$	MAX	45 mA	
I_L	$I_G=20mA$ $T_j=25^\circ C$	MAX	65 mA	
V_{TM}	$I_{OUT}=1.4A$ $tp=380\mu s$ $T_j=25^\circ C$	MAX	1.3 V	
V_{TO}	$T_j=125^\circ C$	MAX	0.8 V	
R_d	$T_j=125^\circ C$	MAX	300 m Ω	
I_{DRM} / I_{RRM}	$V_{OUT}=700V$	$T_j=25^\circ C$	MAX	2 μA
		$T_j=125^\circ C$	MAX	200
dV/dt	$V_{OUT}=460V$ gate open $T_j=110^\circ C$	MIN	500 V/ μs	
$(dI/dt)_c$	$(dV/dt)_c=20V/\mu s$ $T_j=125^\circ C$	MIN	0.5 A/ms	
V_{CL}	$I_{CL}=1mA$ $tp=1ms$ $T_j=25^\circ C$	TYP	1100 V	

Fig. A: Turn-off operation of the ACS110 switch with an electro-valve: waveform of the pin OUT current I_{OUT} and Out-COM voltage V_{OUT} .

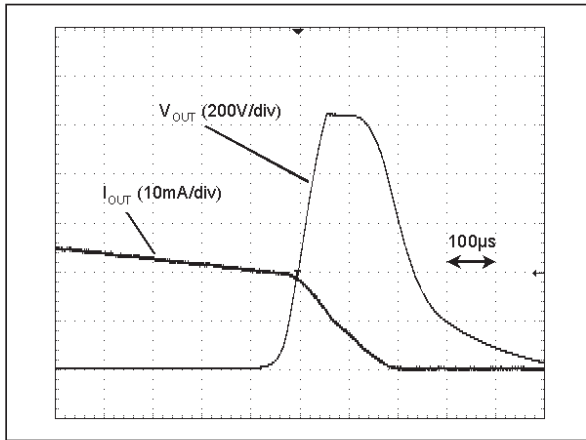
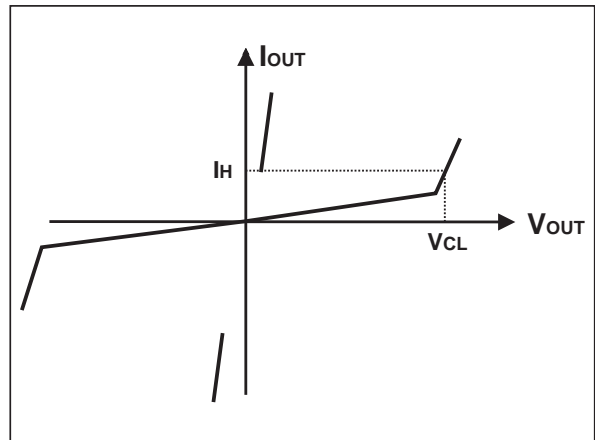

Fig. B: ACS110 switch static characteristic.



AC LINE TRANSIENT VOLTAGE RUGGEDNESS

The ACS110 switch is able to sustain safely the AC line transient voltages either by clamping the low energy spikes or by breaking over under high energy shocks, even with high turn-on current rises.

The test circuit of the figure C is representative of the final ACS application and is also used to stress the ACS switch according to the IEC 61000-4-5 standard conditions. Thanks to the load, the ACS switch sustains the voltage spikes up to 2 kV above the peak line voltage. It will break over safely even on resistive load where the turn on current rise is high as shown on figure D. Such non repetitive test can be done 10 times on each AC line voltage polarity.

Fig. C: Overvoltage ruggedness test circuit for resistive and inductive loads according to IEC61000-4-5 standards. $R = 150\Omega$, $L = 10\mu H$, $V_{PP} = 2kV$.

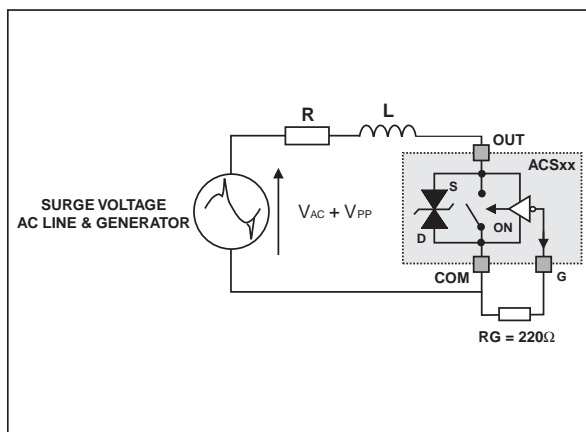
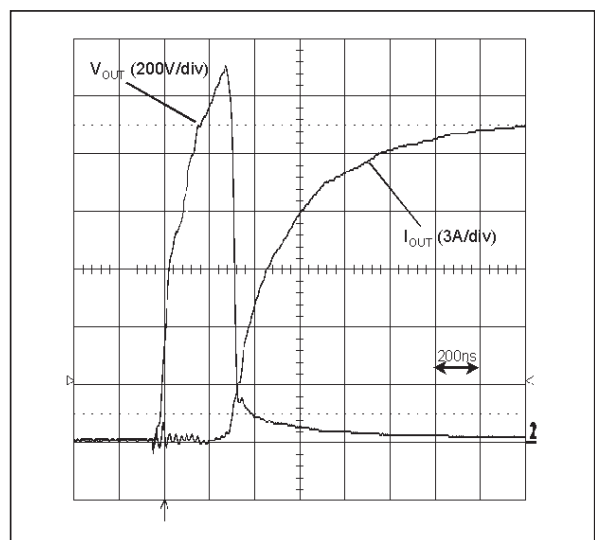

Fig. D: Current and Voltage of the ACS110 during IEC61000-4-5 standard test with $R = 150\Omega$, $L = 10\mu H$ & $V_{PP} = 2kV$.



OTHER FIGURES

- Maximum power dissipation vs RMS on state current.
- RMS on-state current vs ambient temperature, case temperature and package
- Relative variation of thermal impedance junction to ambient vs pulse duration and package
- Relative variation of gate trigger current vs junction temperature
- Relative variation of holding and latching current vs junction
- Relative variation of dV/dt vs T_j
- Relative variation of $(dV/dt)_c$ vs $(di/dt)_c$
- Surge peak on-state current vs number of cycles
- Non repetitive surge peak on-state current for a sinusoidal pulse with $t_p < 10ms$, and corresponding of I_T .
- On-state characteristics (maximal values)
- Thermal resistance junction to ambient vs copper surface under tab
- Relative variation of critical $(di/dt)_c$ vs junction temperature

Fig. 1: Maximum power dissipation versus RMS on-state current.

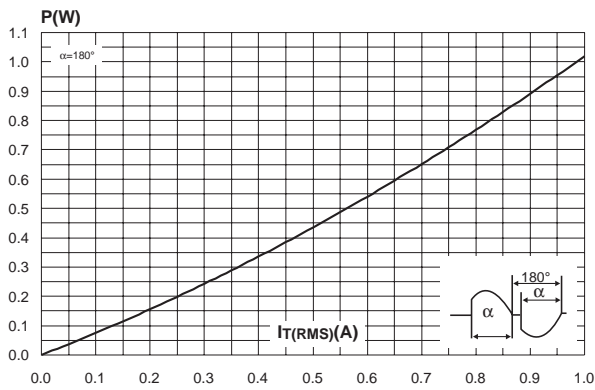

Fig. 2-1: RMS on-state current versus tab or lead temperature.

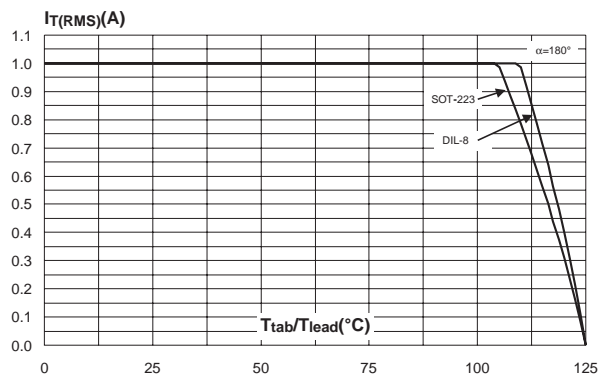

Fig. 2-2: RMS on-state current versus ambient temperature.

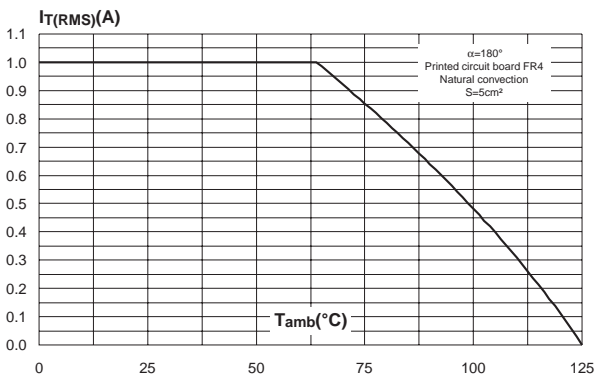

Fig. 3: Relative variation of thermal impedance junction to ambient versus pulse duration.

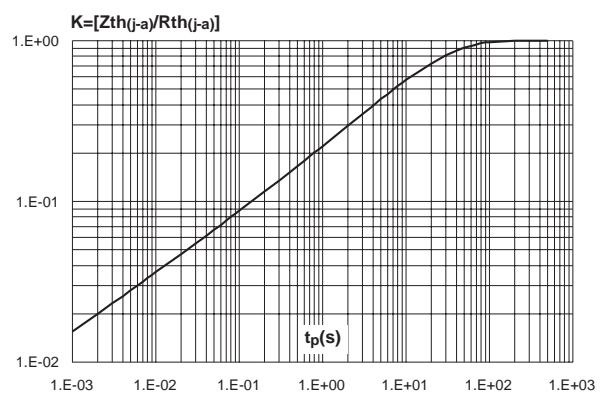

Fig. 4: Relative variation of gate trigger current, holding current and latching versus junction temperature (typical values).

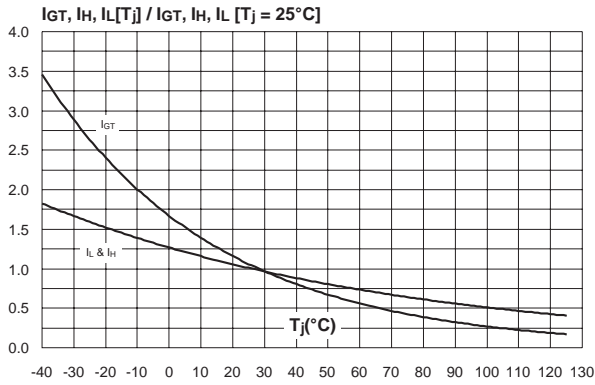

Fig. 5: Relative variation of static dV/dt versus junction temperature.

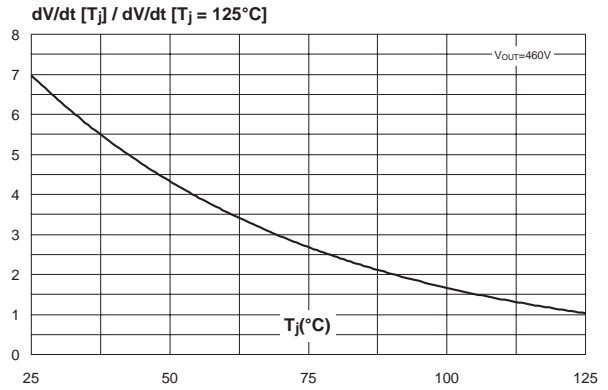

Fig. 6: Relative variation of critical rate of decrease of main current versus reapplied dV/dt (typical values).

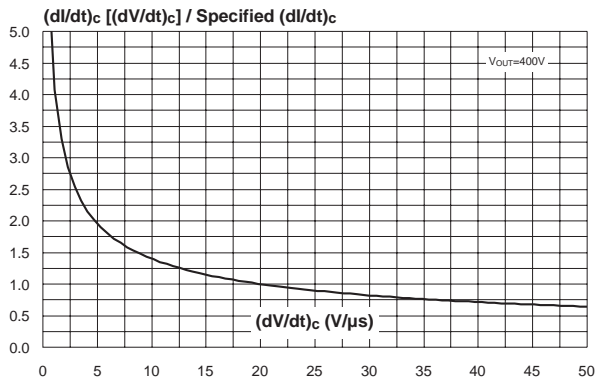

Fig. 7: Relative variation of critical rate of decrease of main current versus junction temperature.

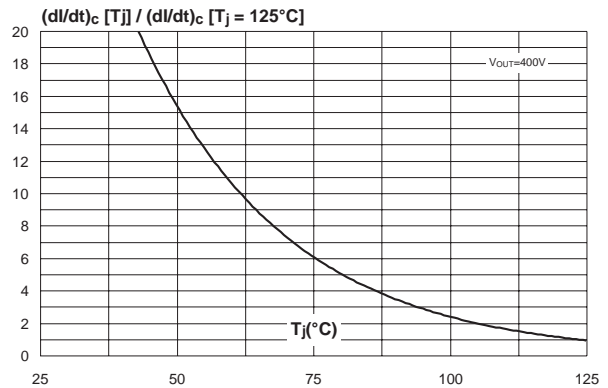

Fig. 8: Surge peak on-state current versus number of cycles.

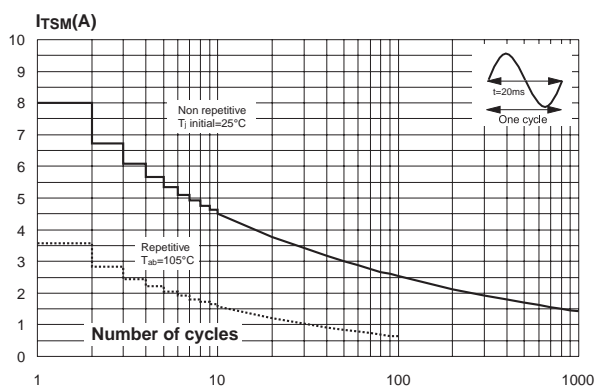

Fig. 9: Non repetitive surge peak on-state current for a sinusoidal pulse with width $t_p < 10\text{ms}$, and corresponding value of I^2t .

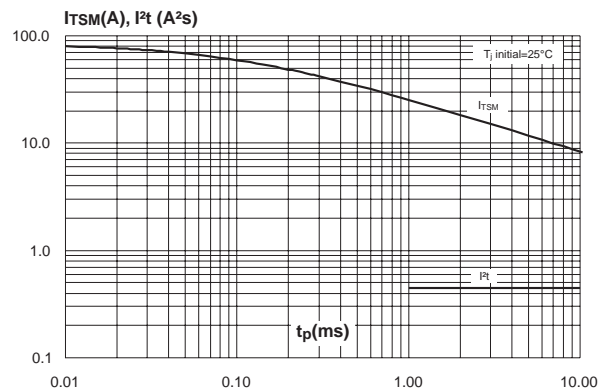

Fig. 10: On-state characteristics (maximum values).

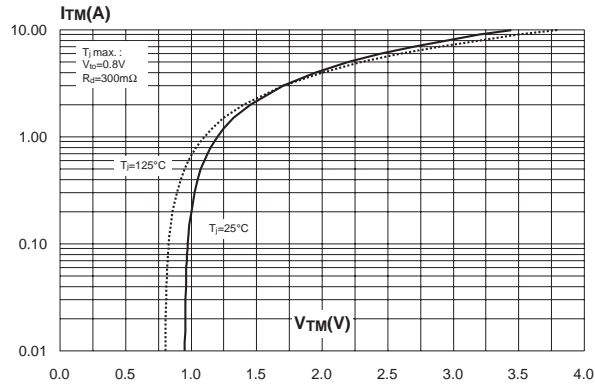
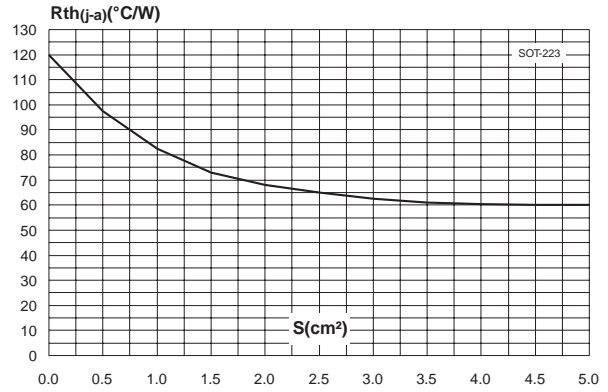
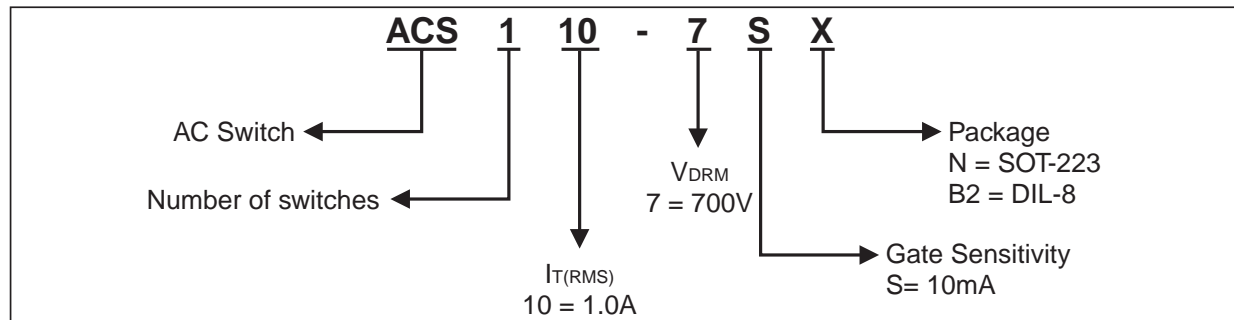

Fig. 11: Thermal resistance junction to ambient versus copper surface under tab (printed circuit board FR4, copper thickness: 35µm)



ORDERING INFORMATION



PACKAGE OUTLINE MECHANICAL DATA
SOT-223

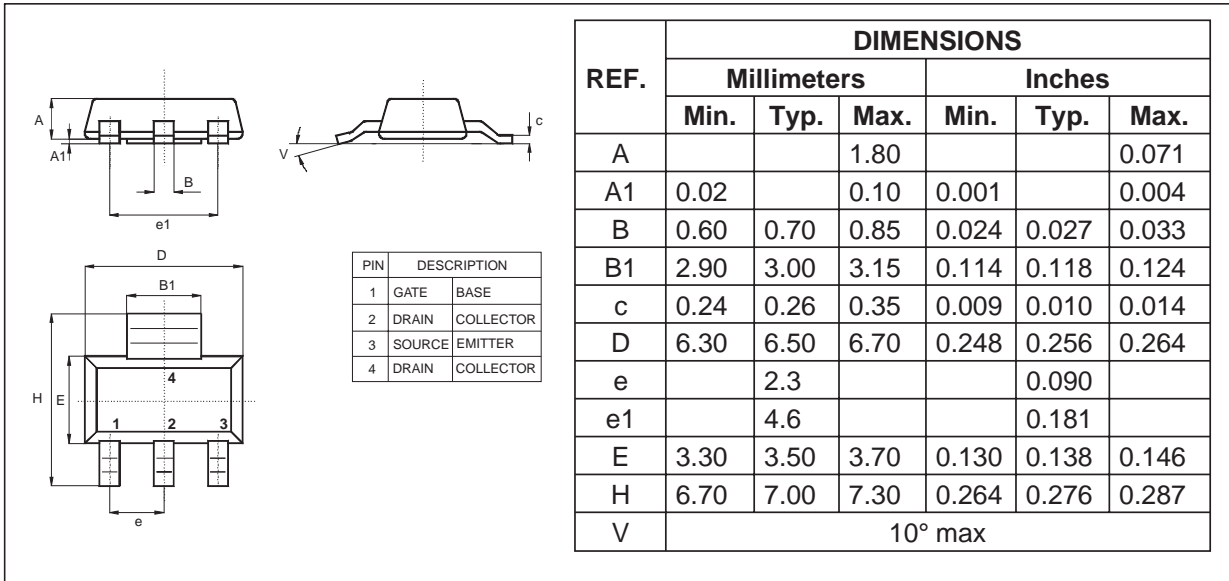

PACKAGE FOOT PRINT
SOT-223

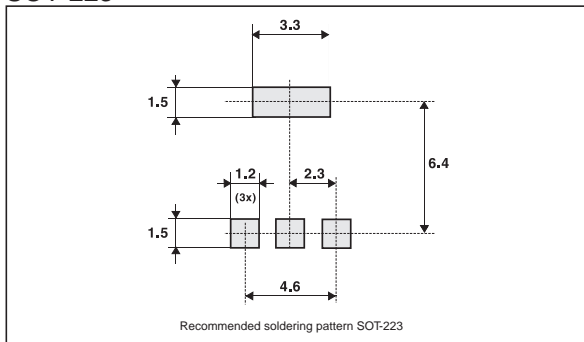

ACS110-7SN/SB2

PACKAGE OUTLINE MECHANICAL DATA DIL-8

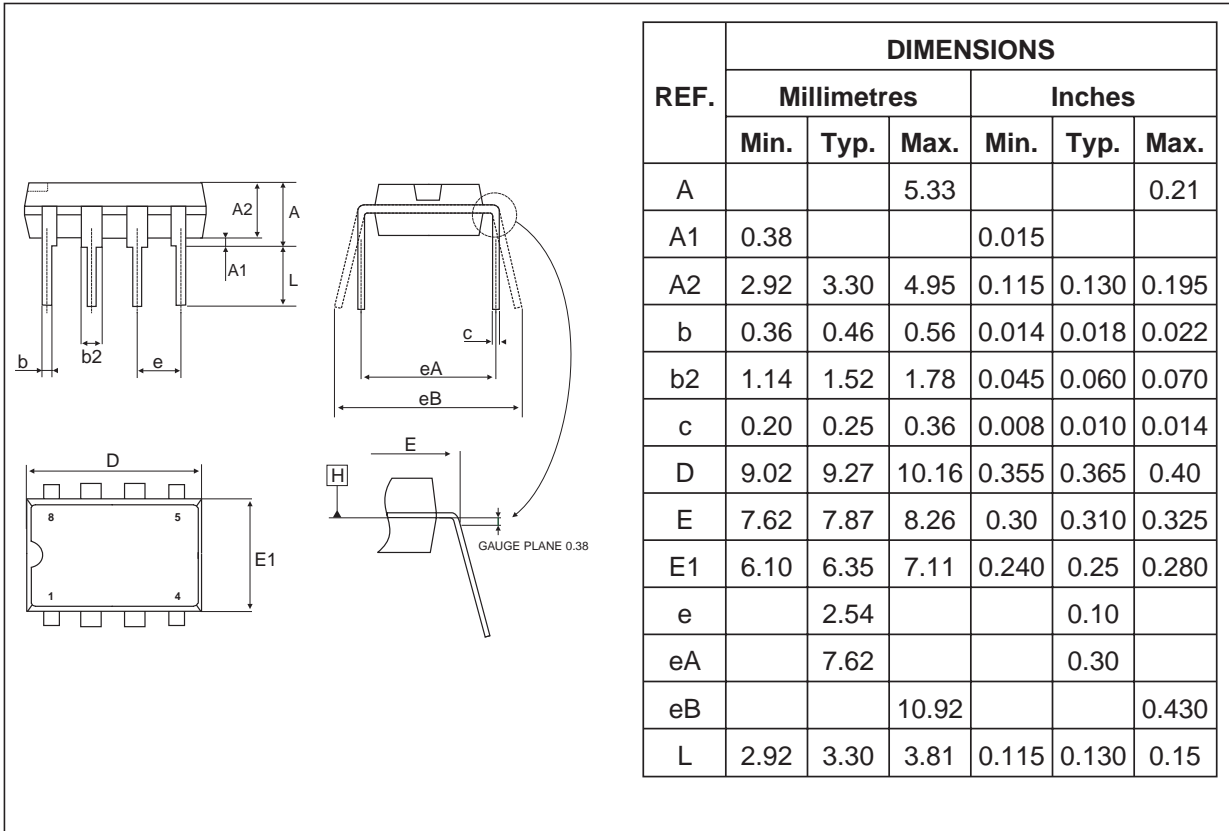

OTHER INFORMATION

Ordering type	Marking	Package	Weight	Base qty	Delivery mode
ACS110-7SN	ACS1107S	SOT-223	0.12 g	1000	Tape & reel
ACS110-7SB2	ACS1107S	DIL8	0.6 g	50	Tube

- Epoxy meets UL94,V0

Information furnished is believed to be accurate and reliable. However, STMicroelectronics assumes no responsibility for the consequences of use of such information nor for any infringement of patents or other rights of third parties which may result from its use. No license is granted by implication or otherwise under any patent or patent rights of STMicroelectronics. Specifications mentioned in this publication are subject to change without notice. This publication supersedes and replaces all information previously supplied. STMicroelectronics products are not authorized for use as critical components in life support devices or systems without express written approval of STMicroelectronics.

The ST logo is a registered trademark of STMicroelectronics
 © 2003 STMicroelectronics - Printed in Italy - All rights reserved.
 STMicroelectronics GROUP OF COMPANIES
 Australia - Brazil - Canada - China - Finland - France - Germany
 Hong Kong - India - Israel - Italy - Japan - Malaysia - Malta - Morocco - Singapore
 Spain - Sweden - Switzerland - United Kingdom - United States.

<http://www.st.com>



X-ON Electronics

Largest Supplier of Electrical and Electronic Components

Click to view similar products for [Triacs](#) category:

Click to view products by [STMicroelectronics](#) manufacturer:

Other Similar products are found below :

[CTA08-1000CW](#) [CTB24-800BW](#) [CTA08-1000C](#) [CTA12-800BWPT](#) [CTA16-1000B](#) [CTB24-800B](#) [BT137-600-0Q](#) [5615](#) [OT415Q](#) [2N6075A](#)
[NTE5629](#) [NTE5688](#) [CTB08-400CW](#) [D31410](#) [T2535T-8I](#) [BTA425Z-800BTQ](#) [KS100N12](#) [TOPT16-800C0,127](#) [OT408,135](#) [BT134-800E](#)
[BT136D](#) [BTB16Q-600BW](#) [Z0409MF](#) [BTA04-600B](#) [BTA06-600BRG](#) [BTA06-800BWRG](#) [BTA08-600BRG](#) [BTA08-800B](#) [BT136-600,127](#)
[MAC97A6,116](#) [BT137-600E,127](#) [BTB16-600CW3G](#) [BTB16-600CW3G](#) [Z0109MN,135](#) [T825T-6I](#) [T1220T-6I](#) [NTE5638](#) [ACST1235-8FP](#)
[BT136X-600E,127](#) [MAC4DLM-1G](#) [BT134-600D,127](#) [BTA08-600BW3G](#) [NTE56008](#) [NTE56017](#) [NTE56018](#) [NTE56059](#) [NTE5608](#)
[NTE5609](#) [NTE5656](#) [NTE56020](#)