

SMALL SIGNAL SCHOTTKY DIODE

FEATURES AND BENEFITS

- VERY SMALL CONDUCTION LOSSES
- NEGLIGIBLE SWITCHING LOSSES
- LOW FORWARD VOLTAGE DROP
- EXTREMELY FAST SWITCHING
- SURFACE MOUNTED DEVICE

DESCRIPTION

Schottky barrier diode encapsulated in a SOD-323 small SMD package.

This device is intended for use in portable equipments. It is suited for DC to DC converters, step-up conversion and power management.

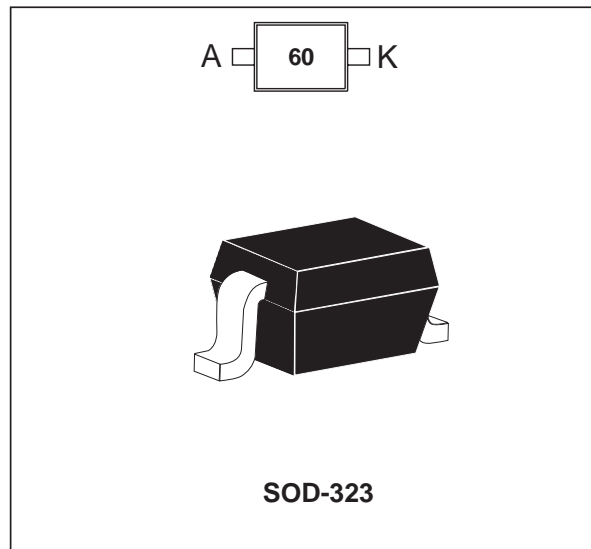

ABSOLUTE RATINGS (limiting values)

Symbol	Parameter		Value	Unit
V_{RRM}	Repetitive peak reverse voltage		10	V
I_F	Peak forward current	$\delta = 0.11$	3	A
I_{FSM}	Surge non repetitive forward current	$t_p = 10\text{ms}$	5	A
P_{tot}	Power Dissipation	$T_a = 25^\circ\text{C}$	310	mW
T_{stg}	Storage temperature range		- 65 to +150	$^\circ\text{C}$
T_j	Maximum operating junction temperature *		150	$^\circ\text{C}$
TL	Maximum temperature for soldering during 10s		260	$^\circ\text{C}$

* : $\frac{dP_{tot}}{dT_j} < \frac{1}{R_{th(j-a)}}$ thermal runaway condition for a diode on its own heatsink

THERMAL RESISTANCE

Symbol	Parameter	Value	Unit
$R_{th(j-a)}$	Junction to ambient (*)	400	$^\circ\text{C/W}$

(*) Mounted on epoxy board with recommended pad layout.

BAT60J

STATIC ELECTRICAL CHARACTERISTICS

Symbol	Tests Conditions	Tests conditions		Min.	Typ.	Max.	Unit
V_F^*	Forward voltage drop	$T_j = 25^\circ\text{C}$	$I_F = 10\text{ mA}$		0.28	0.32	V
			$I_F = 100\text{ mA}$		0.35	0.40	
			$I_F = 1\text{ A}$		0.53	0.58	
I_R^{**}	Reverse leakage current	$T_j = 25^\circ\text{C}$	$V_R = 5\text{ V}$		1	3	μA
		$T_j = 25^\circ\text{C}$	$V_R = 8\text{ V}$		1.3	4	
		$T_j = 25^\circ\text{C}$	$V_R = 10\text{ V}$		2	6	
		$T_j = 25^\circ\text{C}$	$V_R = 12\text{ V}$		2.5	7.5	
		$T_j = 80^\circ\text{C}$	$V_R = 8\text{ V}$		73	150	

Pulse test: * $t_p = 380\mu\text{s}$, $\delta < 2\%$

** $t_p = 5\text{ms}$, $\delta < 2\%$

To evaluate the conduction losses the following equation:

$$P = 0.38 \times I_{F(AV)} + 0.17 I_{F(RMS)}^2$$

Fig. 1: Average forward power dissipation versus average forward current.

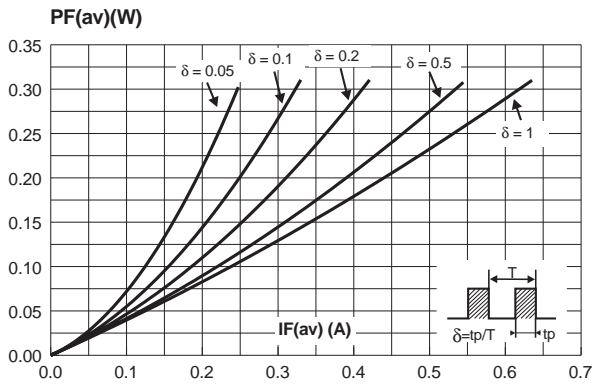

Fig. 2-1: Peak forward current versus ambient temperature ($\delta = 0.11$).

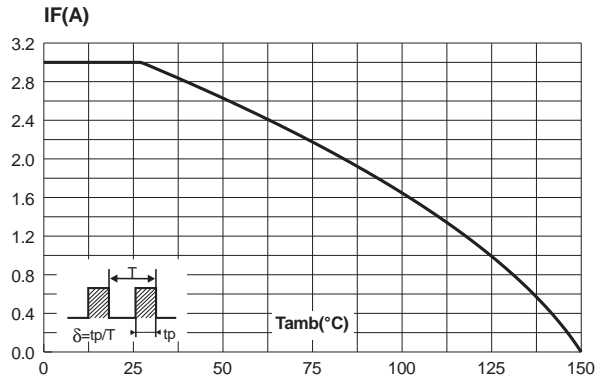

Fig. 2-2: Average forward current versus ambient temperature ($\delta = 0.5$).

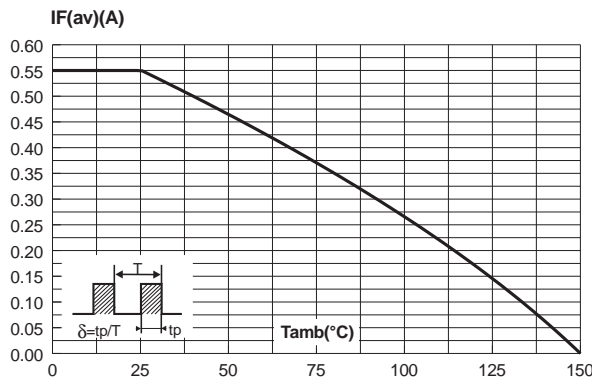

Fig. 3: Non repetitive surge peak forward current versus overload duration (maximum values).

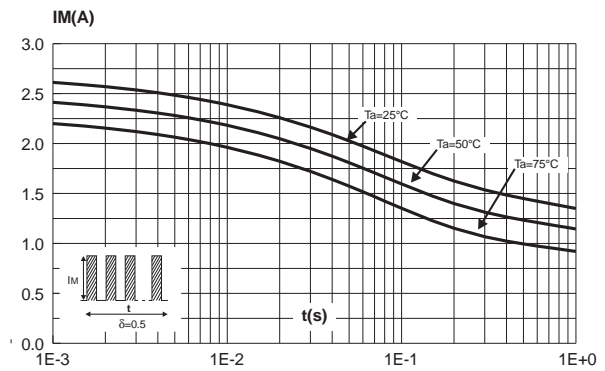

Fig. 4: Relative variation of thermal impedance junction to ambient versus pulse duration (Epoxy printed circuit board FR4 with recommended pad layout).

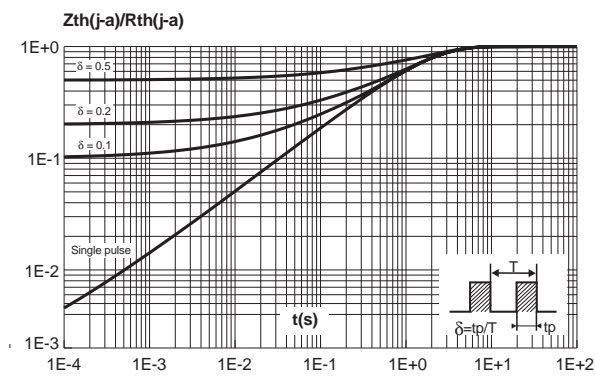
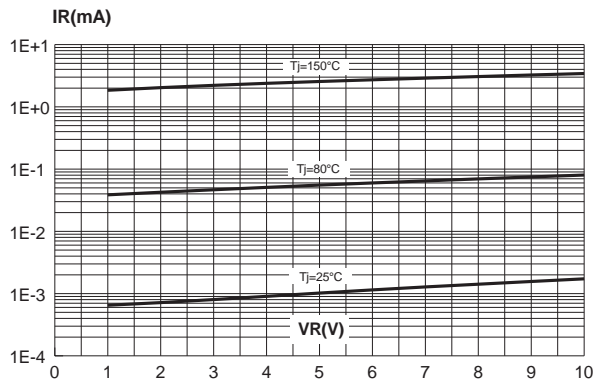

Fig. 5: Reverse leakage current versus reverse voltage applied (typical values).



BAT60J

Fig. 6: Reverse leakage current versus junction temperature (typical values).

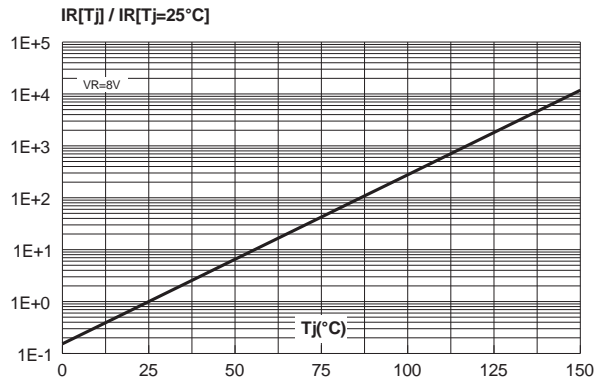

Fig. 7: Junction capacitance versus reverse voltage applied (typical values).

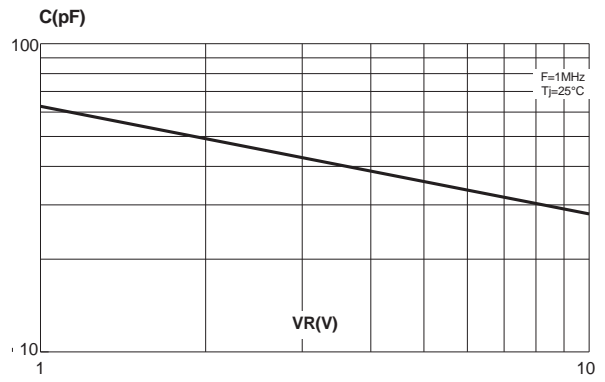

Fig. 8-1: Forward voltage drop versus forward current (High level).

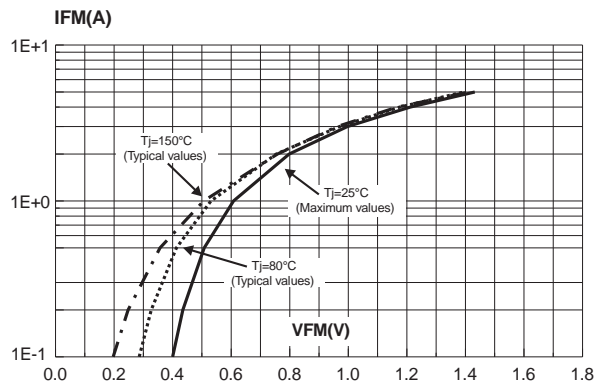

Fig. 8-2: Forward voltage drop versus forward current (Low level).

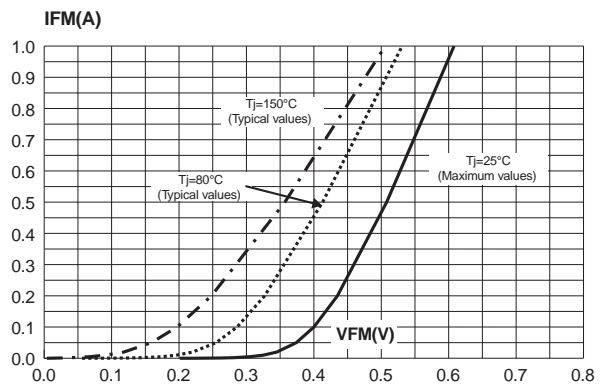
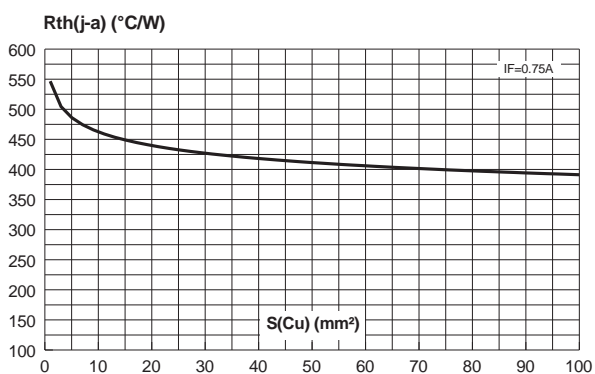

Fig. 9: Thermal resistance junction to ambient versus copper surface (epoxy printed circuit board FR4, copper thickness: 35µm).



PACKAGE MECHANICAL DATA
 SOD-323

REF.	DIMENSIONS			
	Millimeters		Inches	
	Min.	Max.	Min.	Max.
A		1.17		0.046
A1	0	0.1	0	0.004
b	0.25	0.44	0.01	0.017
c	0.1	0.25	0.004	0.01
D	1.52	1.8	0.06	0.071
E	1.11	1.45	0.044	0.057
H	2.3	2.7	0.09	0.106
L	0.1	0.46	0.004	0.02
Q1	0.1	0.41	0.004	0.016

MARKING

Type	Marking	Package	Weight	Base qty	Delivery mode
BAT60JFILM	60	SOD-323	0.005 g.	3000	Tape & reel

- Epoxy meets UL94V-0

Information furnished is believed to be accurate and reliable. However, STMicroelectronics assumes no responsibility for the consequences of use of such information nor for any infringement of patents or other rights of third parties which may result from its use. No license is granted by implication or otherwise under any patent or patent rights of STMicroelectronics. Specifications mentioned in this publication are subject to change without notice. This publication supersedes and replaces all information previously supplied. STMicroelectronics products are not authorized for use as critical components in life support devices or systems without express written approval of STMicroelectronics.

The ST logo is a registered trademark of STMicroelectronics

© 2003 STMicroelectronics - Printed in Italy - All rights reserved.

STMicroelectronics GROUP OF COMPANIES

Australia - Brazil - Canada - China - Finland - France - Germany
 Hong Kong - India - Israel - Italy - Japan - Malaysia - Malta - Morocco - Singapore
 Spain - Sweden - Switzerland - United Kingdom - United States.

<http://www.st.com>

X-ON Electronics

Largest Supplier of Electrical and Electronic Components

Click to view similar products for [Schottky Diodes & Rectifiers](#) category:

Click to view products by [STMicroelectronics](#) manufacturer:

Other Similar products are found below :

[MA4E2039](#) [D1FH3-5063](#) [MBR10100CT-BP](#) [MBR1545CT](#) [MMBD301M3T5G](#) [RB160M-50TR](#) [RB551V-30](#) [BAS16E6433HTMA1](#) [BAT](#)
[54-02LRH E6327](#) [NSR05F40QNXT5G](#) [NTE555](#) [JANS1N6640](#) [SB07-03C-TB-H](#) [SB1003M3-TL-W](#) [SK310-T](#) [SK32A-LTP](#) [SK33A-TP](#)
[SK34B-TP](#) [SS3003CH-TL-E](#) [GA01SHT18](#) [CRS10I30A\(TE85L,QM](#) [MA4E2501L-1290](#) [MBRB30H30CT-1G](#) [SB007-03C-TB-E](#) [SK32A-TP](#)
[SK33B-TP](#) [SK35A-TP](#) [SK38B-TP](#) [NRVBM120LT1G](#) [NTE505](#) [NTSB30U100CT-1G](#) [SS15E-TP](#) [VS-6CWQ10FNHM3](#) [ACDBA1100LR-HF](#)
[ACDBA1200-HF](#) [ACDBA140-HF](#) [ACDBA2100-HF](#) [ACDBA3100-HF](#) [CDBQC0530L-HF](#) [CDBQC0240LR-HF](#) [ACDBA340-HF](#)
[ACDBA260LR-HF](#) [ACDBA1100-HF](#) [SK310B-TP](#) [MA4E2502L-1246](#) [MA4E2502H-1246](#) [NRVBM120ET1G](#) [NSR01L30MXT5G](#) [NTE573](#)
[NTE6081](#)