

Low capacitance TVS for high speed lines such as xDSL

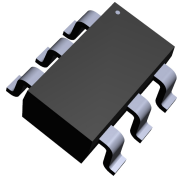

SOT23-6L

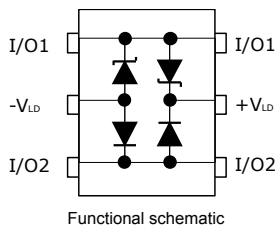

Features

- Voltages: 5 to 24 V
- Low capacitance device: $C_{typ} = 1 \text{ pF}$
- RoHS package
- Low leakage current: 0.2 μA at 25 °C

Complies with the following standards

- IEC 61000-4-2, level 4
 - 15 kV (air discharge)
 - 8 kV (contact discharge)
- IEC 61000-4-5, level 2
 - $\pm 1 \text{ kV}$, 42 Ω
- MIL STD 883G-Method 3015-7: Class 3
 - 8 kV (human body model)

Description

DSL04 is designed to protect VDSL2 line drivers against surges defined in worldwide telecommunication standards. This device protects line drivers in CPE and DSLAM applications. The low capacitance makes it suitable from ADSL to VDSL2 data rates.

Middle points (-VLD, +VLD) can be either connected or not depending on application requirements.

DSL04 is able to survive severe conditions even when used with downgraded or oscillating gas tube.

This device is packaged in a SOT23-6L.

Product status link

[DSL04](#)

1 Characteristics

Table 1. Absolute ratings ($T_{amb} = 25\text{ °C}$)

Symbol	Parameter		Value	Unit
V_{pp}	Peak pulse voltage	IEC 61000-4-5 contact discharge	30	kV
I_{pp}	Peak pulse current	8/20 μ s	15	A
T_{stg}	Storage junction temperature range		-55 to +150	°C
T_j	Operating junction temperature range		-40 to +125	
T_L	Maximum temperature for soldering during 10 s		260	°C

Table 2. Electrical characteristics ($T_{amb} = 25\text{ °C}$)

Order code	I_{RM} at V_{RM}		V_{BR} at I_{BR}		V_{CL} AT I_{PP} 8/20 μ s		$C^{(1)}$		$\Delta C^{(2)}$
	Max. μ A	V	Min. V	mA	Max. V	A	Typ. pF	Max. pF	Typ. pF
DSL04-005SC6	0.2	5	6.5	1	20	15	1	3	0.3
DSL04-008SC6	0.2	8	10	1	25	15	1	3	0.3
DSL04-010SC6	0.2	10	11	1	27	15	1	3	0.3
DSL04-012SC6	0.2	12	14	1	31	15	1	3	0.3
DSL04-016SC6	0.2	16	20	1	37	15	1	3	0.3
DSL04-018SC6	0.2	18	21	1	39	15	1	3	0.3
DSL04-020SC6	0.2	20	23	1	42	15	1	3	0.3
DSL04-022SC6	0.2	22	25	1	45	15	1	3	0.3
DSL04-024SC6	0.2	24	27	1	52	15	1	3	0.3

1. Test conditions: $V_R = 2\text{ V}$ bias, $V_{RMS} = 1\text{ V}$, $f = 1\text{ MHz}$

2. Measured between 1 V and V_{RM}

1.1 Characteristics (curves)

Figure 1. Leakage current versus junction temperature (typical values)

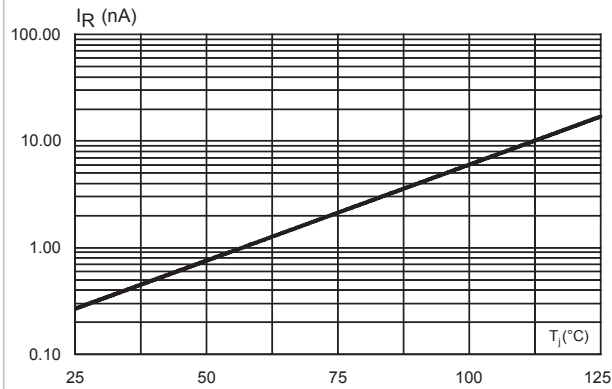

Figure 2. Junction capacitance versus reverse voltage applied (typical values)

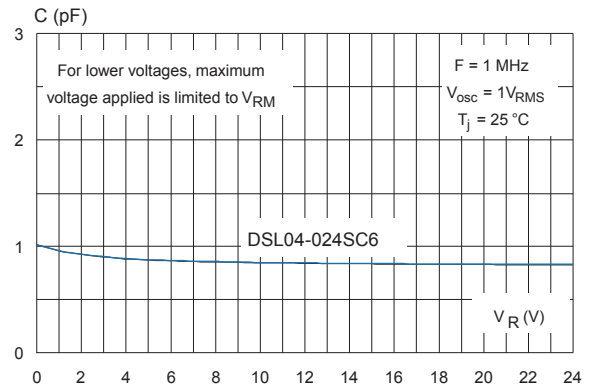
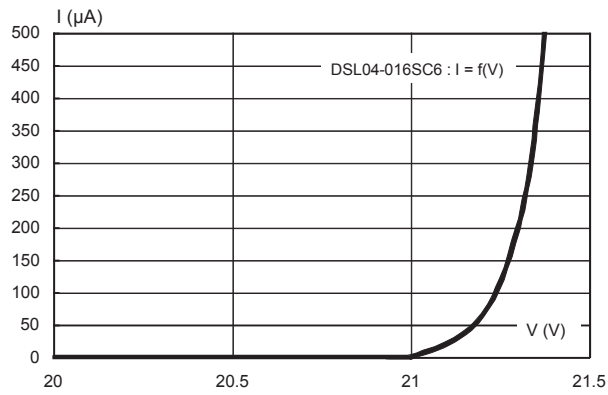

Figure 3. I / V characteristics (typical values)



2 Package information

In order to meet environmental requirements, ST offers these devices in different grades of **ECOPACK** packages, depending on their level of environmental compliance. ECOPACK specifications, grade definitions and product status are available at: www.st.com. ECOPACK is an ST trademark.

2.1 SOT23-6L package information

- Epoxy meets UL 94, V0
- Lead-free package

Figure 4. SOT23-6L package outline

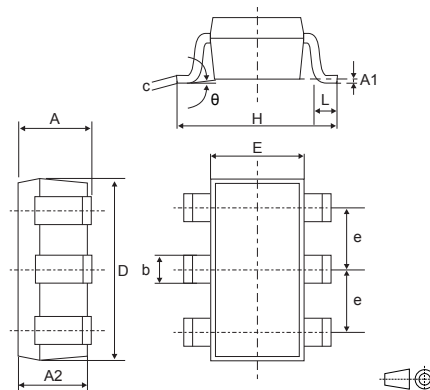

Table 3. SOT23-6L package mechanical data

Ref.	Dimensions					
	Millimeters			Inches		
	Min.	Typ.	Max.	Min.	Typ.	Max.
A	0.9		1.45	0.0354		0.0571
A1	0		0.15	0		0.0059
A2	0.9		1.3	0.0354		0.0512
b	0.30		0.5	0.0118		0.0197
c	0.09		0.2	0.0035		0.0079
D	2.8		3.05	0.1102		0.1201
E	1.5		1.75	0.0591		0.0689
e		0.95			0.0374	
H	2.6		3	0.1024		0.1181
L	0.3		0.6	0.0118		0.0236
θ	0		10	0		0.3937

Figure 5. Footprint recommendations, dimensions in mm (inches)

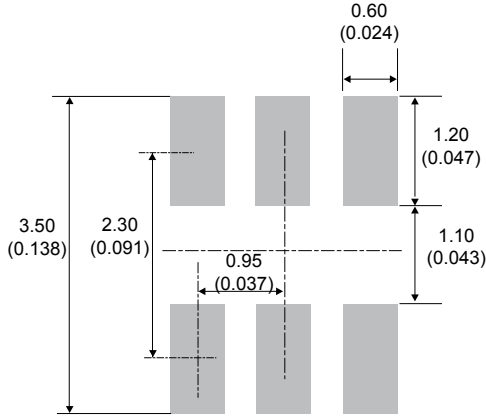

Figure 6. Marking layout (refer to ordering information table for marking)

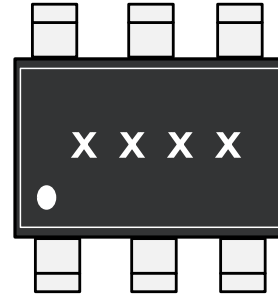
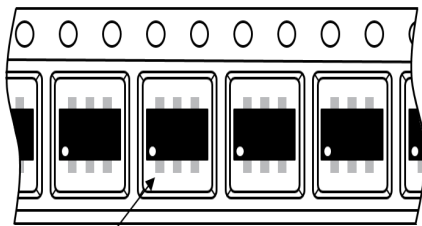

Figure 7. Package orientation in reel



Pin 1 located according to EIA-481

Note: Pocket dimensions are not on scale
Pocket shape may vary depending on package

Figure 8. Tape and reel orientation

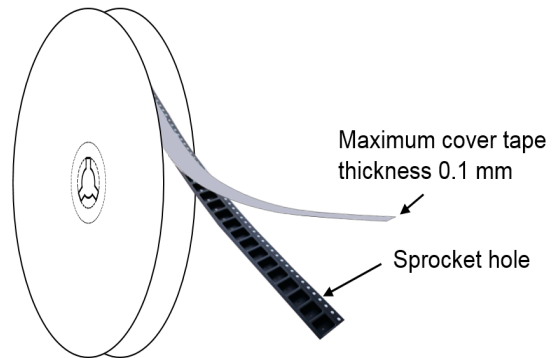

Figure 9. Reel dimensions (mm)

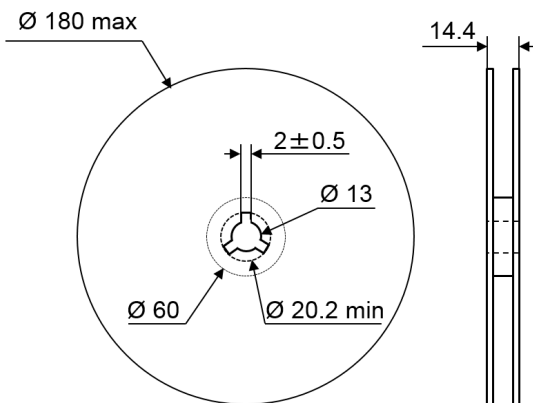

Figure 10. Inner box dimensions (mm)

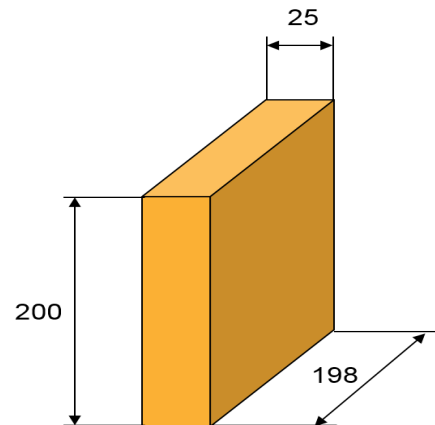
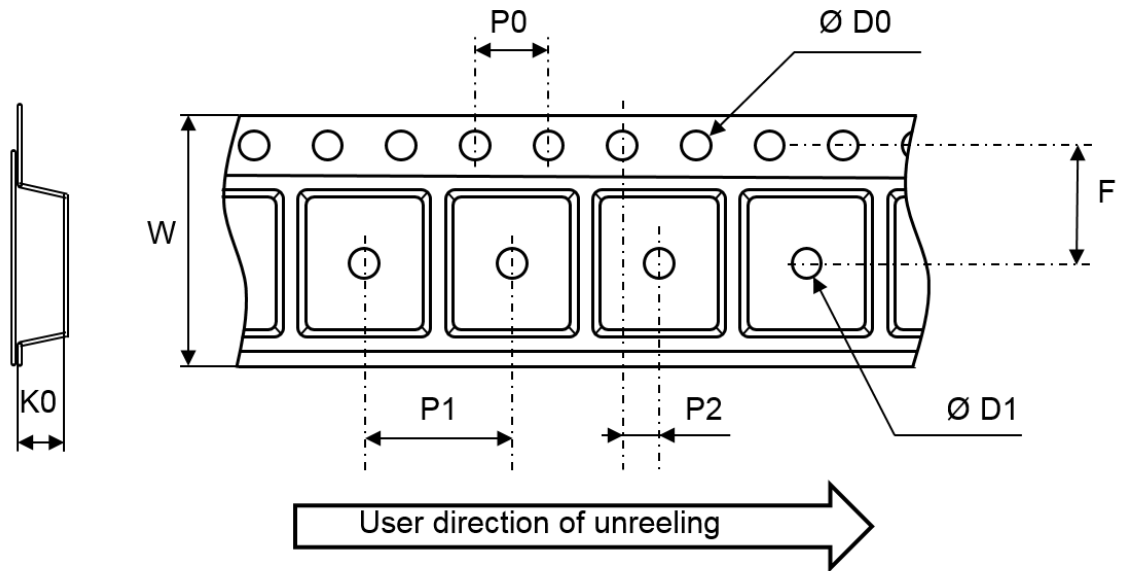

Figure 11. Tape and reel outline



Note: Pocket dimensions are not on scale
Pocket shape may vary depending on package

Table 4. Tape and reel mechanical data

Ref.	Dimensions		
	Millimeters		
	Min.	Typ.	Max.
P1	3.9	4	4.1
P0	3.9	4	4.1
D0	1.45	1.5	1.6
D1	1		
F	3.45	3.5	3.55
K0	1.3	1.4	1.6
P2	1.95	2	2.05
W	7.9	8	8.3

2.2 Reflow profile

Figure 12. ST ECOPACK recommended soldering reflow profile for PCB mounting

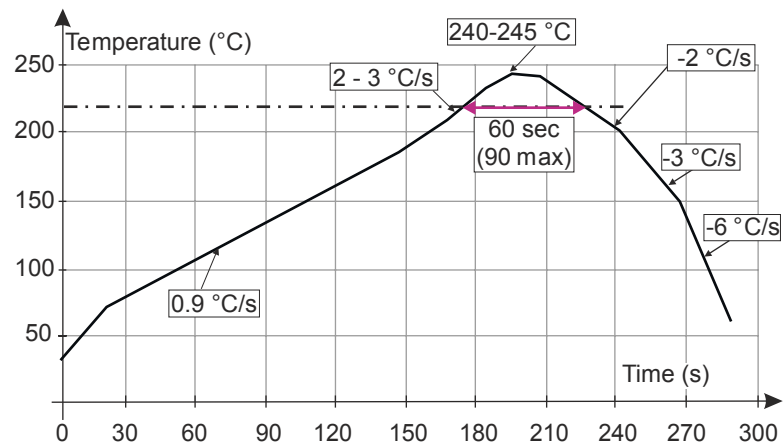

Note: Minimize air convection currents in the reflow oven to avoid component movement. Maximum soldering profile corresponds to the latest IPC/JEDEC J-STD-020.

3 Ordering information

Table 5. Ordering information

Order code	Marking	Package	Weight	Base qty.	Delivery mode
DSL04-005SC6	DT05	SOT23-6L	14 mg	3000	Tape and reel
DSL04-008SC6	DT08				
DSL04-010SC6	DT10				
DSL04-012SC6	DT12				
DSL04-016SC6	DT16				
DSL04-018SC6	DT18				
DSL04-020SC6	DT20				
DSL04-022SC6	DT22				
DSL04-024SC6	DT24				

Revision history

Table 6. Document revision history

Date	Revision	Changes
24-Feb-2012	1	Initial release.
03-Feb-2015	2	Reformatted to current standard.
25-Nov-2019	3	<p>Updated Section DSL04 schematics, Section Features and Section Complies with the following standards.</p> <p>Added Figure 12. ST ECOPACK recommended soldering reflow profile for PCB mounting.</p> <p>Removed fig. 8 Ordering information scheme.</p>

IMPORTANT NOTICE – PLEASE READ CAREFULLY

STMicroelectronics NV and its subsidiaries (“ST”) reserve the right to make changes, corrections, enhancements, modifications, and improvements to ST products and/or to this document at any time without notice. Purchasers should obtain the latest relevant information on ST products before placing orders. ST products are sold pursuant to ST’s terms and conditions of sale in place at the time of order acknowledgement.

Purchasers are solely responsible for the choice, selection, and use of ST products and ST assumes no liability for application assistance or the design of Purchasers’ products.

No license, express or implied, to any intellectual property right is granted by ST herein.

Resale of ST products with provisions different from the information set forth herein shall void any warranty granted by ST for such product.

ST and the ST logo are trademarks of ST. For additional information about ST trademarks, please refer to www.st.com/trademarks. All other product or service names are the property of their respective owners.

Information in this document supersedes and replaces information previously supplied in any prior versions of this document.

© 2019 STMicroelectronics – All rights reserved

X-ON Electronics

Largest Supplier of Electrical and Electronic Components

Click to view similar products for [Surge Suppressors](#) category:

Click to view products by [STMicroelectronics](#) manufacturer:

Other Similar products are found below :

[GUS1](#) [GUS12](#) [BSPM1A600D600LVR](#) [2800521](#) [29-2053](#) [GUS11](#) [GUS2](#) [GUS3](#) [GUS4](#) [30460](#) [SRA64C060X](#) [PC642C015](#) [1810-15-A3](#)
[2713175](#) [4B06B-EC1-150LF](#) [SRA6LC](#) [BPMA75D100LV](#) [CX06M](#) [CCTV1](#) [GUS13](#) [GUS14](#) [GUS5](#) [GUS6](#) [VAL-MS 320/3+0-FM](#) [VAL-US-](#)
[120/40/1+1-FM](#) [VAL-US-120/65/1+1-FM](#) [VAL-US-480D/30/3+0-FM](#) [VAL-US-120/40/1+0-FM](#) [STCHSP121BT1RU](#) [LP-BFDN-CW](#) [LP-](#)
[STRL-NFF](#) [LP-STRL-DFE](#) [GUS22](#) [0804111](#) [5053609](#) [5053201](#) [SPD2-150-1P0](#) [SPD2-550-1P0](#) [6720005416](#) [6720005417](#) [1-2191595-2](#)
[STC-CAT6-P0E-I](#) [SPD2-350-1P0](#) [FLT-CP-350-ST](#) [TTC-6P-3-HF-F-M-12DC-UT-I](#) [SMTPA200](#) [2800989](#) [2906776](#) [2906810](#) [2906847](#)