

## Ultra low capacitance ESD protection

Datasheet - production data

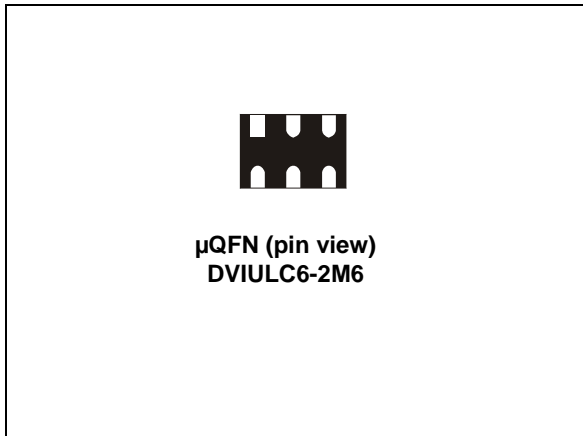

### Features

- 2-line ESD protection (at 15 kV air and contact discharge, exceeds IEC 61000-4-2)
- Protects  $V_{BUS}$  when applicable
- Ultra low capacitance: 0.6 pF at  $F = 825$  MHz
- Fast response time compared with varistors
- Low leakage current: 0.5  $\mu$ A max
- RoHS compliant

### Benefits

- ESD standards compliance guaranteed at device level, hence greater immunity at system level
- ESD protection of  $V_{BUS}$  when applicable.
- Large bandwidth to minimize impact on data signal quality
- Consistent D+ / D- signal balance:
  - Ultra low impact on intra- and inter-pair skew
  - Matching high bit rate DVI, and IEEE 1394 requirements
- Low PCB space consumption - 1.45 mm<sup>2</sup> for  $\mu$ QFN

- Low leakage current for longer operation of battery powered devices
- Higher reliability offered by monolithic integration
- 500  $\mu$ m pitch for  $\mu$ QFN 6 leads

### Complies with these standards

- IEC 61000-4-2 level 4
  - 15 kV air discharge
  - 8 kV contact discharge
- MIL STD883G-Method 3015-7

### Applications

- DVI ports up to 1.65 Gb/s
- IEEE 1394a, b, and c up to 3.2 Gb/s
- USB2.0 ports up to 480 Mb/s (high speed), backwards compatible with USB1.1 low and full speed
- Ethernet port: 10/100/1000 Mb/s
- SIM card protection
- Video line protection

### Description

The DVIULC6-2M6 is a monolithic, application specific discrete device dedicated to ESD protection of high speed interfaces, such as DVI, IEEE 1394a, b and c, USB2.0, Ethernet links and video lines.

Its ultra low line capacitance secures a high level of signal integrity without compromising in protecting sensitive chips against the most stringently characterized ESD strikes.

# 1 Characteristics

Figure 1. Functional diagram

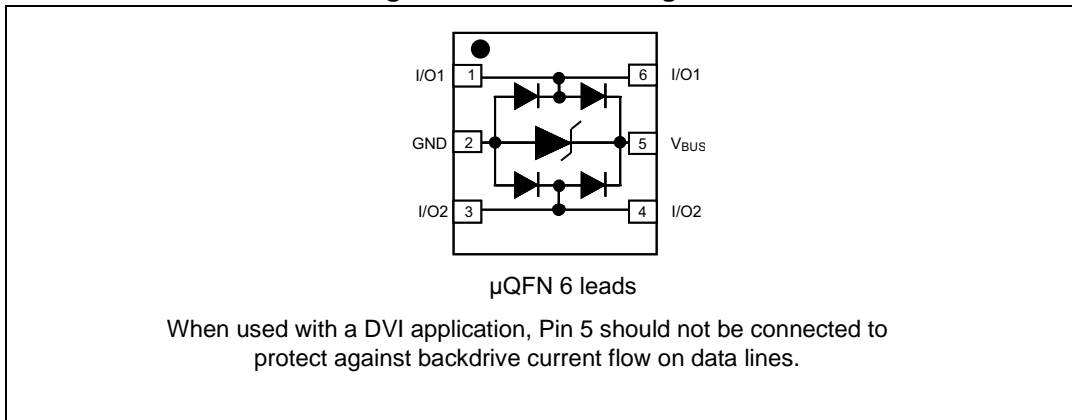

Table 1. Absolute ratings

Symbol	Parameter		Value	Unit
$V_{PP}$	Peak pulse voltage	IEC61000-4-2 air discharge IEC61000-4-2 contact discharge MIL STD883G-Method 3015-7	±15 ±15 ±25	kV
$T_{stg}$	Storage temperature range		-55 to +150	°C
$T_j$	Maximum junction temperature		125	°C
$T_L$	Lead solder temperature (10 seconds duration)		260	°C

Table 2. Electrical characteristics ( $T_{amb} = 25\text{ °C}$ )

Symbol	Parameter	Test Conditions	Value			Unit
			Min.	Typ.	Max	
$I_{RM}$	Leakage current	$V_{RM} = 5\text{ V}$			0.5	μA
$V_{BR}$	Breakdown voltage between $V_{BUS}$ and GND	$I_R = 1\text{ mA}$	6			V
$V_{CL}$	Clamping voltage	$I_{PP} = 1\text{ A}$ , $t_p = 8/20\text{ }\mu\text{s}$ Any I/O pin to GND			12	V
		$I_{PP} = 5\text{ A}$ , $t_p = 8/20\text{ }\mu\text{s}$ Any I/O pin to GND			17	V
$C_{i/o-GND}$	Capacitance between I/O and GND	$V_R = 0\text{ V}$ , $F = 825\text{ MHz}$			0.85	pF
$\Delta C_{i/o-GND}$	Capacitance variation between I/O and GND	$V_R = 0\text{ V}$ , $F = 1\text{ MHz}$		0.02		pF
$C_{i/o-i/o}$	Capacitance between I/O	$V_R = 0\text{ V}$ , $F = 825\text{ MHz}$			0.5	pF

Figure 2. Line capacitance versus line voltage (typical values)

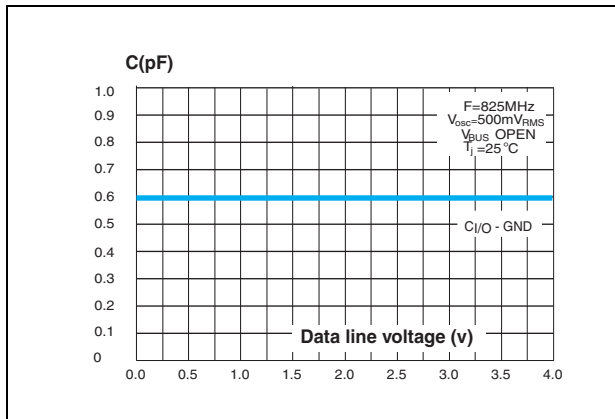

Figure 3. Line capacitance versus frequency (typical values) DVIULC6-2M6

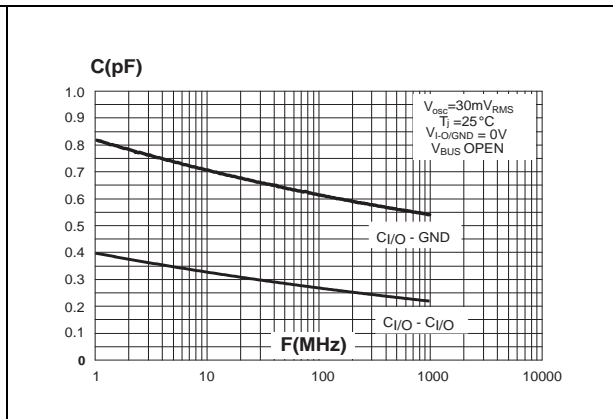

Figure 4. Frequency response (typical values) DVIULC6-2M6

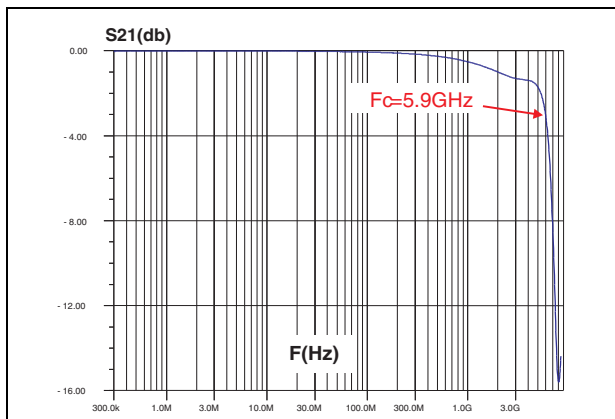

Figure 5. Relative variation of leakage current versus junction temperature (typical values)

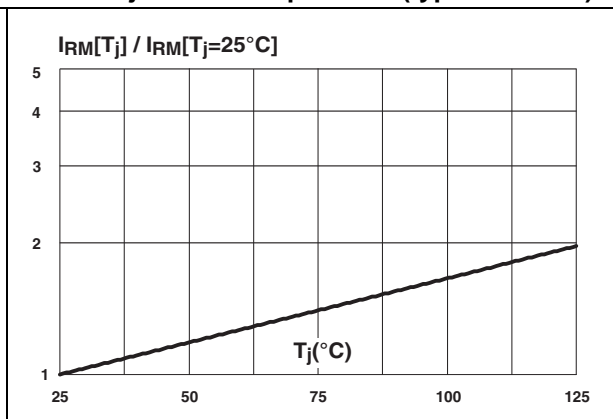

Figure 6. Eye diagram at 1.65 Gbps amplitude 500 mV PCB + DVIULC6-2M6

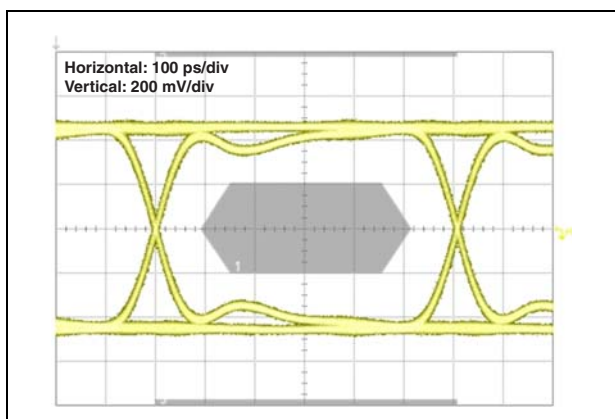
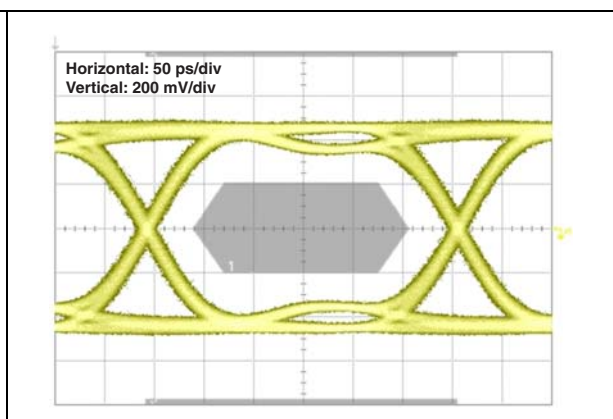

Figure 7. Eye diagram at 3.2 Gbps amplitude 500 mV PCB + DVIULC6-2M6



## 2 Application examples

Figure 8. DVI single link application

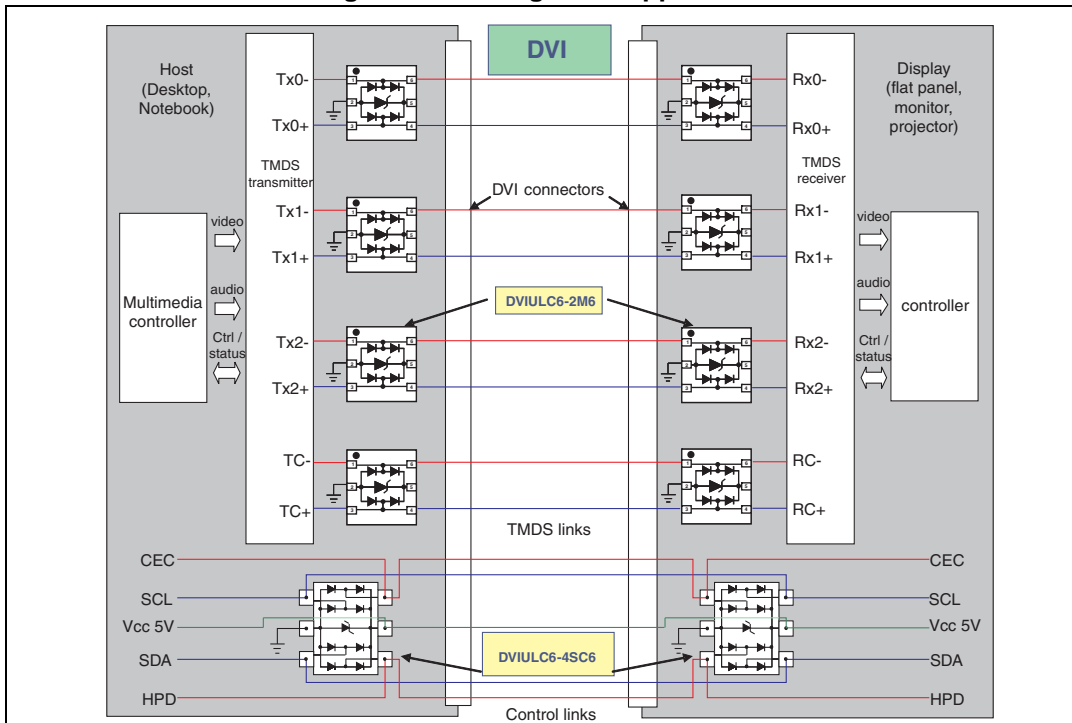
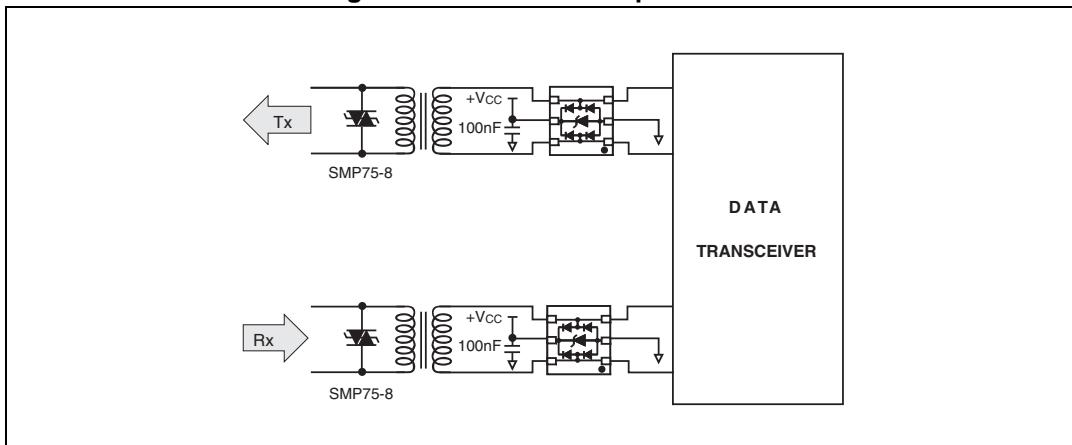

Figure 9. T1/E1/Ethernet protection



## 2.1 PCB layout considerations

Figure 10. PCB layout example

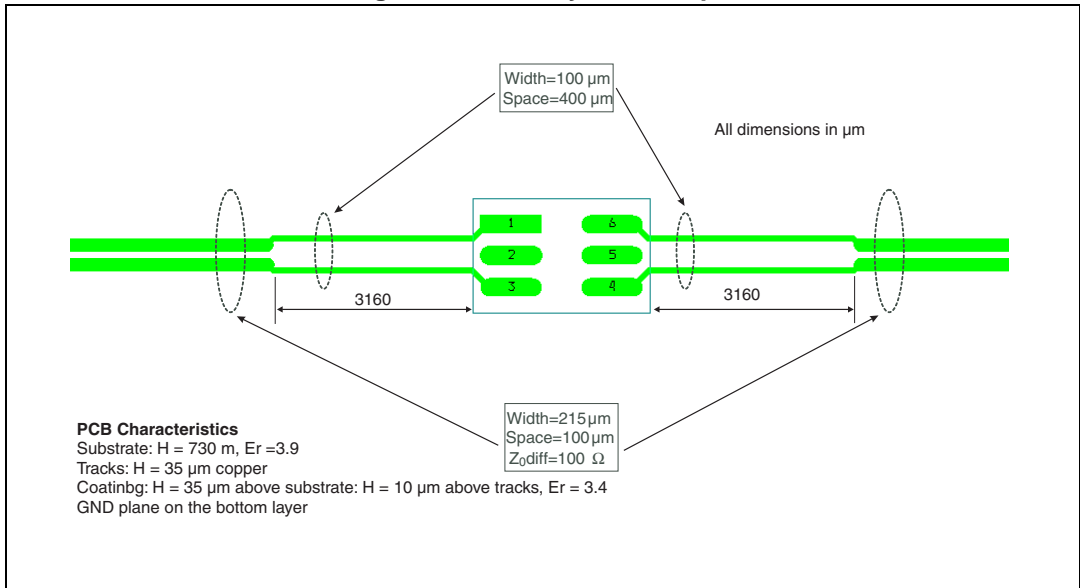
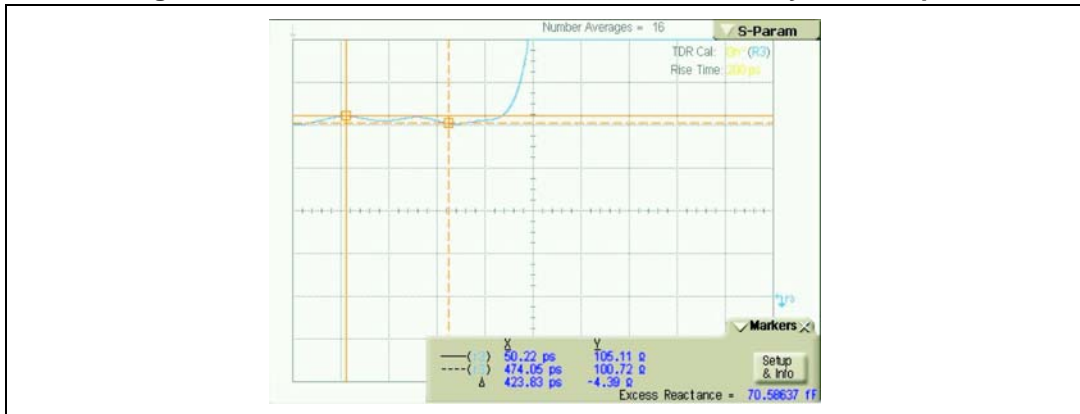

Figure 11. TDR results for DVIULC6-2M6 with PCB layout example



### 3 Technical information

#### 3.1 Surge protection

The DVIULC6-2M6 is particularly optimized to perform ESD surge protection based on the rail to rail topology.

The clamping voltage  $V_{CL}$  can be calculated as follows:

$$V_{CL+} = V_{TRANSIL} + V_F \quad \text{for positive surges}$$

$$V_{CL-} = -V_F \quad \text{for negative surges}$$

with:  $V_F = V_T + R_d \cdot I_p$

( $V_F$  forward drop voltage) / ( $V_T$  forward drop threshold voltage)

and  $V_{TRANSIL} = V_{BR} + R_{d\_TRANSIL} \cdot I_p$

##### Calculation example

We assume that the value of the dynamic resistance of the clamping diode is typically:  $R_d = 0.5 \Omega$  and  $V_T = 1.1 V$ .

We assume that the value of the dynamic resistance of the transil diode is typically  $R_{d\_TRANSIL} = 0.5 \Omega$  and  $V_{BR} = 6.1 V$

For an IEC 61000-4-2 surge Level 4 (Contact Discharge:  $V_g = 8 kV$ ,  $R_g = 330 \Omega$ ),  $V_{BUS} = +5 V$ , and, in first approximation, we assume that:  $I_p = V_g / R_g = 24 A$ .

We find:

$$V_{CL+} = +31.2 V$$

$$V_{CL-} = -13.1 V$$

*Note:* The calculations do not take into account phenomena due to parasitic inductances.

#### 3.2 Surge protection application example

If we consider that the connections from the pin  $V_{BUS}$  to  $V_{CC}$ , from I/O to data line, and from GND to PCB GND plane are two tracks 10 mm long and 0.5 mm wide, we can assume that the parasitic inductances,  $L_{VBUS}$ ,  $L_{I/O}$ , and  $L_{GND}$ , of these tracks are about 6 nH. So when an IEC 61000-4-2 surge occurs on the data line, due to the rise time of this spike ( $t_r = 1 ns$ ), the voltage  $V_{CL}$  has an extra value equal to  $L_{I/O} \cdot di/dt + L_{GND} \cdot di/dt$ .

The  $di/dt$  is calculated as:  $di/dt = I_p/t_r = 24 A/ns$  for an IEC 61000-4-2 surge level 4 (contact discharge  $V_g = 8 kV$ ,  $R_g = 330 \Omega$ )

The over voltage due to the parasitic inductances is:

$$L_{I/O} \cdot di/dt = L_{GND} \cdot di/dt = 6 \times 24 = 144 V$$

By taking into account the effect of these parasitic inductances due to unsuitable layout, the clamping voltage will be:

$$V_{CL+} = +31.2 + 144 + 144 = 319.2 V$$

$$V_{CL-} = -13.1 - 144 - 144 = -301.1 V$$

We can reduce as much as possible these phenomena with simple layout optimization.

Figure 12. IESD behavior: parasitic phenomena due to unsuitable layout

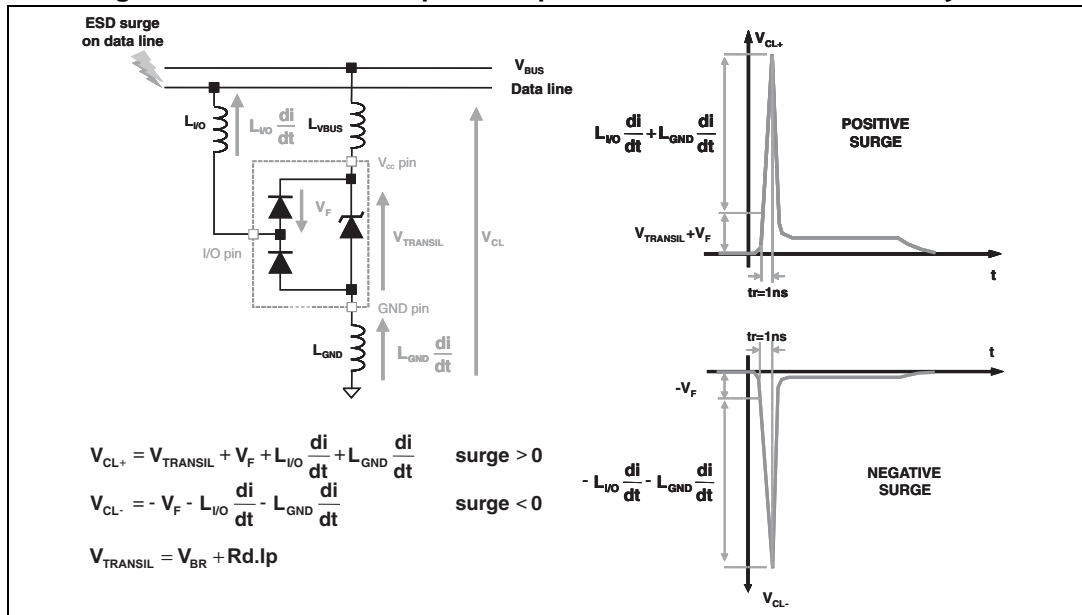

Figure 13. ESD behavior - measurement conditions

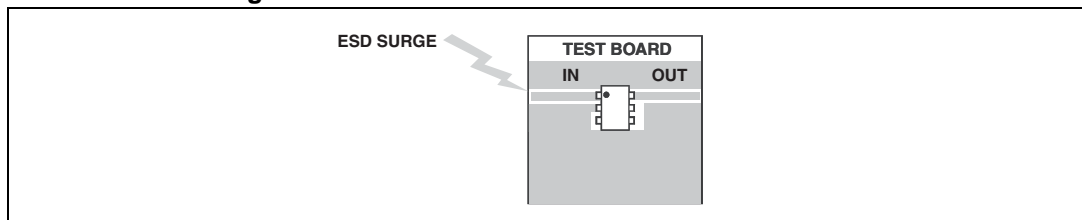

Figure 14. Remaining voltage after the DVIULC6-2M6 during positive ESD surge

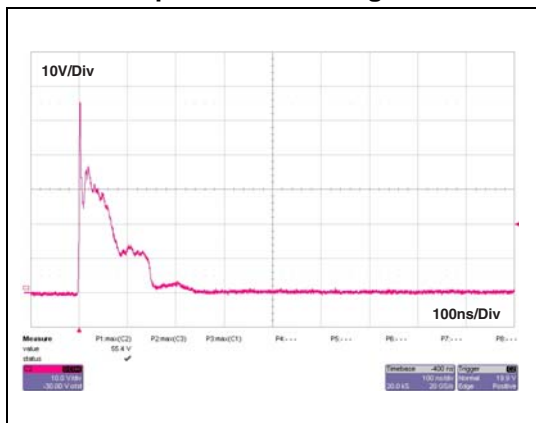

Figure 15. Remaining voltage after the DVIULC6-2M6 during negative ESD surge

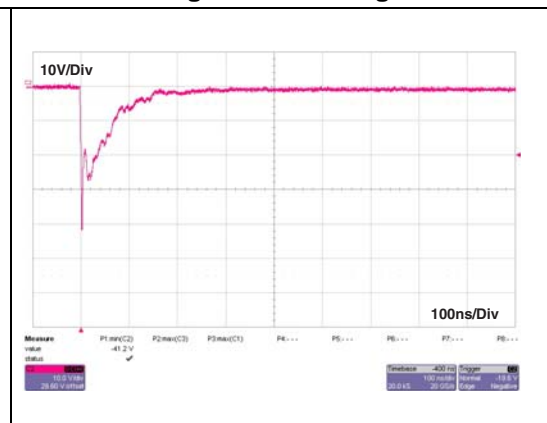
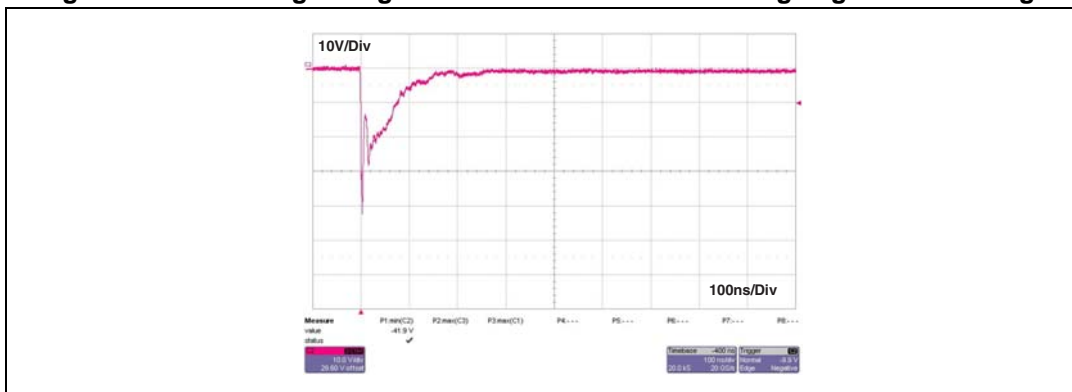

Figure 16. Remaining voltage after the DVIULC6-2M6 during negative ESD surge



### Important

An important precaution to take is to put the protection device as close as possible to the disturbance source (generally the connector).

### 3.3 Crosstalk behavior

Figure 17. Crosstalk phenomena

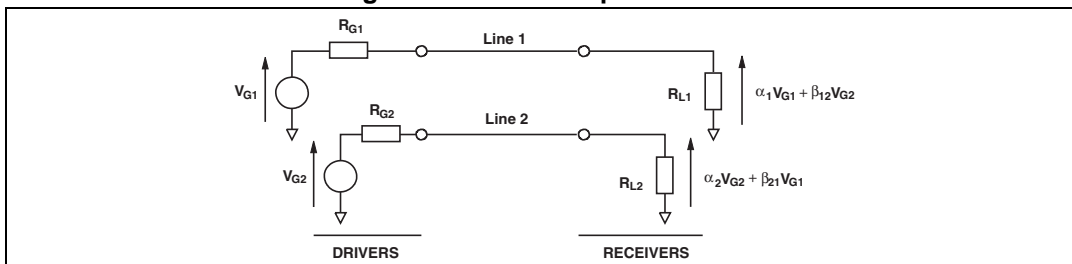

The crosstalk phenomena is due to the coupling between 2 lines. The coupling factor ( $\beta_{12}$  or  $\beta_{21}$ ) increases when the gap across lines decreases, particularly in silicon dice. In the example above the expected signal on load  $R_{L2}$  is  $\alpha_2 V_{G2}$ , in fact the real voltage at this point has got an extra value  $\beta_{21} V_{G1}$ . This part of the  $V_{G1}$  signal represents the effect of the crosstalk phenomenon of the line 1 on the line 2. This phenomenon has to be taken into account when the drivers impose fast digital data or high frequency analog signals in the disturbing line. The perturbed line will be more affected if it works with low voltage signal or high load impedance (few  $k\Omega$ ).

Figure 18. Analog crosstalk measurements

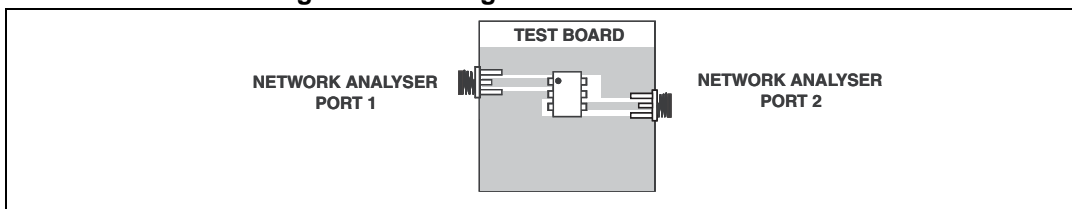
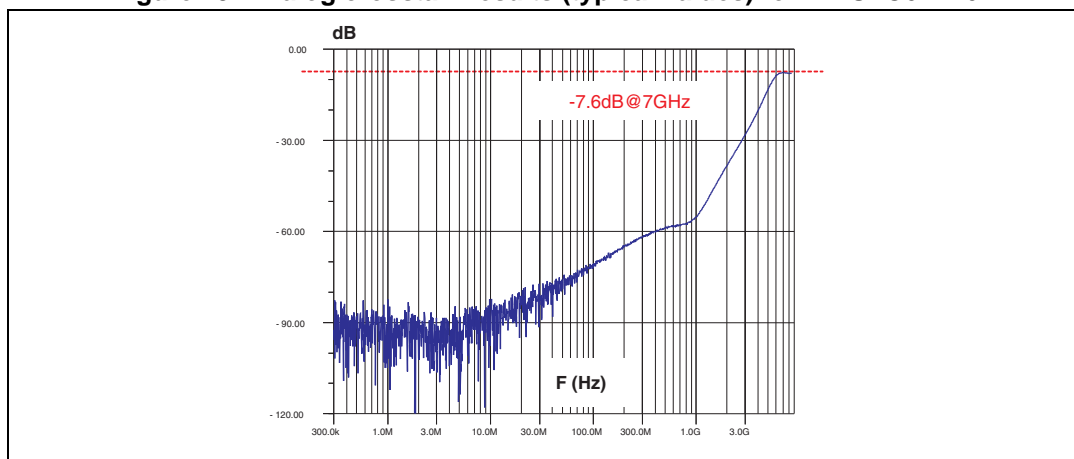

Figure 18 gives the measurement circuit for the analog application. In usual frequency range of analog signals (up to 240 MHz) the effect on disturbed line is less than -40 dB (see Figure 19).



Figure 19. Analog crosstalk results (typical values) for DVIULC6-2M6



## 4 Recommendation on PCB assembly

### 4.1 Stencil opening design

1. General recommendation on stencil opening design
  - a) Stencil opening dimensions: L (Length), W (Width), T (Thickness)

**Figure 20. Stencil opening dimensions.**

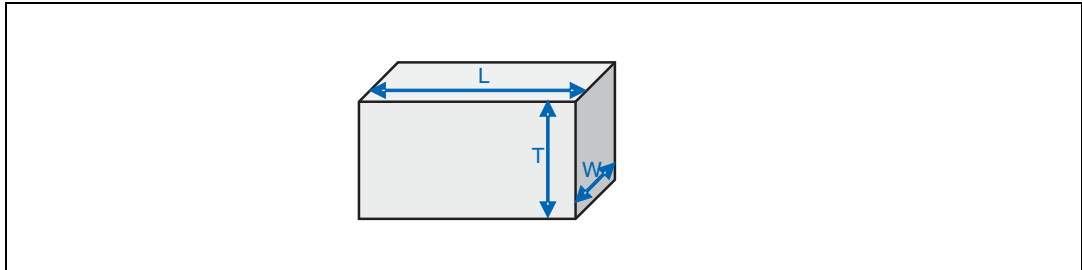

- b) General Design Rule
  - Stencil thickness (T) = 75 ~ 125 μm
  - Aspect Ratio =  $\frac{W}{T} \geq 1.5$
  - Aspect Area =  $\frac{L \times W}{2T(L + W)} \geq 0.66$

2. Reference design
  - a) Stencil opening thickness: 100 μm
  - b) Stencil opening for leads: Opening to footprint ratio is 90%.

**Figure 21. Recommended stencil window position (μQFN only)**

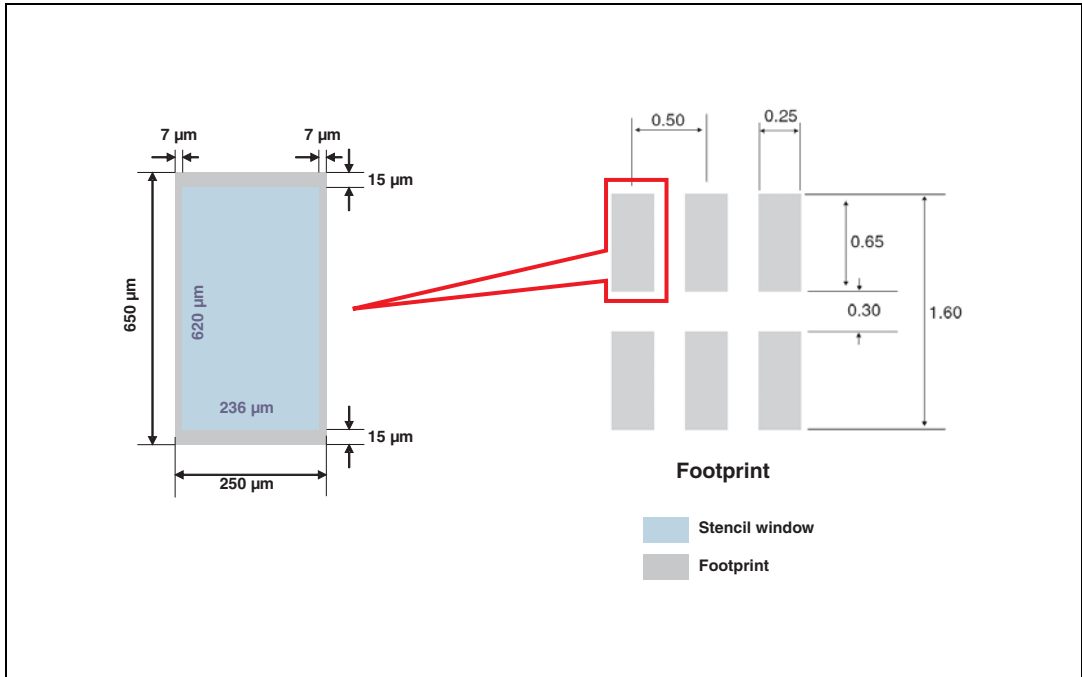

## 4.2 Solder paste

1. Halide-free flux qualification ROL0 according to ANSI/J-STD-004.
2. “No clean” solder paste is recommended.
3. Offers a high tack force to resist component movement during high speed.
4. Solder paste with fine particles: powder particle size is 20-45  $\mu\text{m}$ .

## 4.3 Placement

1. Manual positioning is not recommended.
2. It is recommended to use the lead recognition capabilities of the placement system, not the outline centering.
3. Standard tolerance of  $\pm 0.05$  mm is recommended.
4. 3.5 N placement force is recommended. Too much placement force can lead to squeezed out solder paste and cause solder joints to short. Too low placement force can lead to insufficient contact between package and solder paste that could cause open solder joints or badly centered packages.
5. To improve the package placement accuracy, a bottom side optical control should be performed with a high resolution tool.
6. For assembly, a perfect supporting of the PCB (all the more on flexible PCB) is recommended during solder paste printing, pick and place and reflow soldering by using optimized tools.

## 4.4 PCB design preference

1. To control the solder paste amount, the closed via is recommended instead of open vias.
2. The position of tracks and open vias in the solder area should be well balanced. The symmetrical layout is recommended, in case any tilt phenomena caused by asymmetrical solder paste amount due to the solder flow away.

### 4.5 Reflow profile

Figure 22. ST ECOPACK® recommended soldering reflow profile for PCB mounting

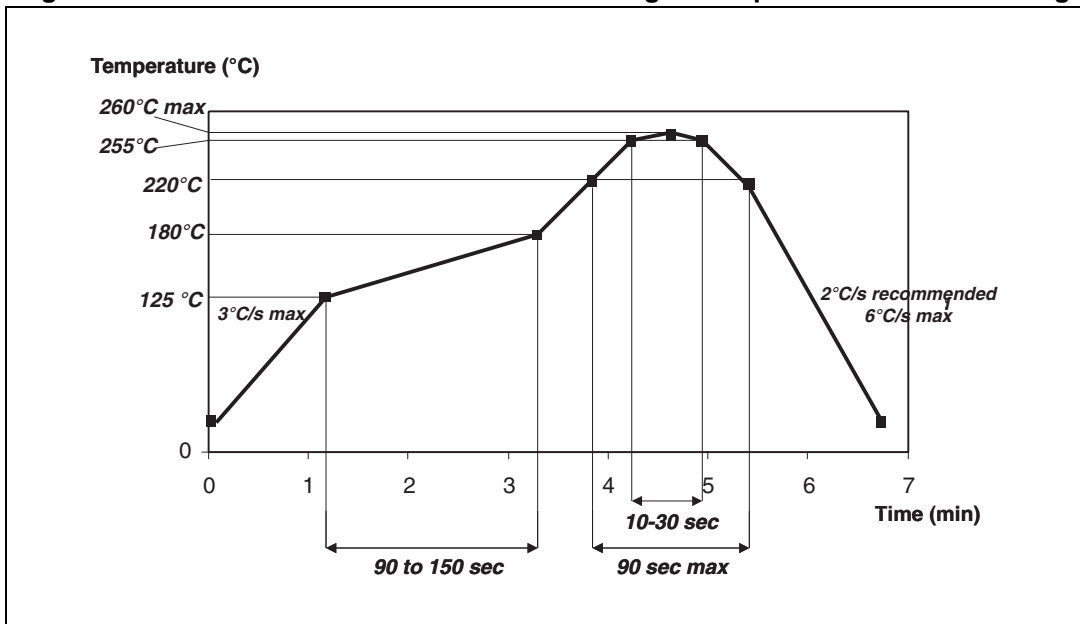

Note: Minimize air convection currents in the reflow oven to avoid component movement.

## 5 Package information

- Epoxy meets UL94, V0

In order to meet environmental requirements, ST offers these devices in ECOPACK® packages. These packages have a lead-free second level interconnect. The category of second level interconnect is marked on the inner box label, in compliance with JEDEC Standard JESD97. The maximum ratings related to soldering conditions are also marked on the inner box label. ECOPACK is an ST trademark. ECOPACK specifications are available at [www.st.com](http://www.st.com).

**Table 3. Micro QFN 1.45x1.00 6L dimensions**

Ref.	Dimensions					
	Millimeters			Inches		
	Min.	Typ.	Max.	Min.	Typ.	Max.
A	0.50	0.55	0.60	0.020	0.022	0.024
A1	0.00	0.02	0.05	0.000	0.001	0.002
b	0.18	0.25	0.30	0.007	0.010	0.012
D		1.45			0.057	
E		1.00			0.039	
e		0.50			0.020	
K	0.20			0.008		
L	0.30	0.35	0.40	0.012	0.014	0.016

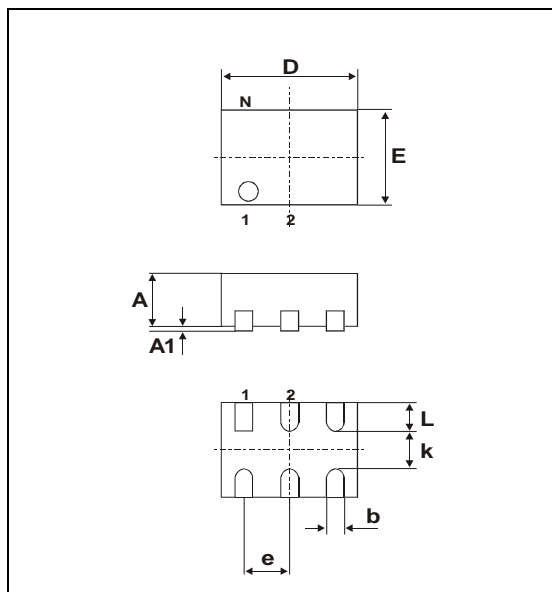

**Figure 23. μQFN 6 leads footprint dimensions in mm [inches]**

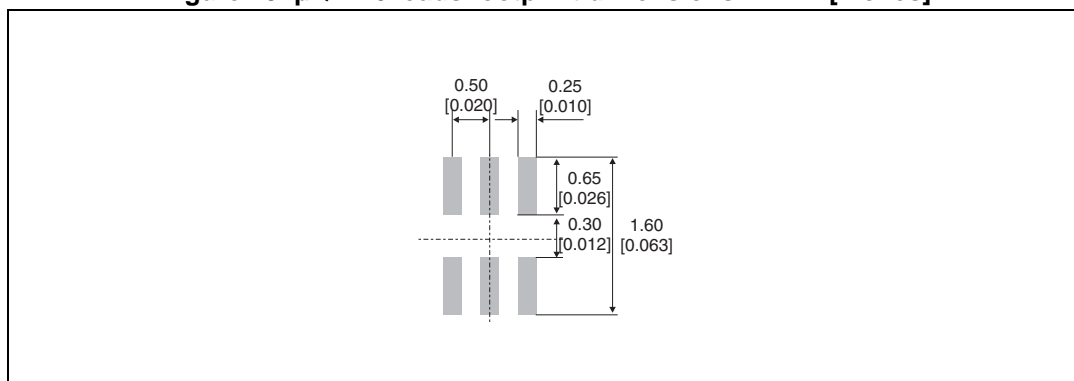

*Note:* Product marking may be rotated by 90° for assembly plant differentiation. In no case should this product marking be used to orient the component for its placement on a PCB. Only pin 1 mark is to be used for this purpose.

## 6 Ordering information

**Table 4. Ordering information**

Order code	Marking	Package	Weight	Base qty	Delivery mode
DVIULC6-2M6	T <sup>(1)</sup>	μQFN 6 leads	2.2 mg	3000	Tape and reel

1. The marking can be rotated by 90° to differentiate assembly location

## 7 Revision history

**Table 5. Document revision history**

Date	Revision	Description of changes
06-May-2008	1	First issue.
13-Oct-2015	2	Removed device in SOT-666 package. Modified document accordingly.

**IMPORTANT NOTICE – PLEASE READ CAREFULLY**

STMicroelectronics NV and its subsidiaries ("ST") reserve the right to make changes, corrections, enhancements, modifications, and improvements to ST products and/or to this document at any time without notice. Purchasers should obtain the latest relevant information on ST products before placing orders. ST products are sold pursuant to ST's terms and conditions of sale in place at the time of order acknowledgement.

Purchasers are solely responsible for the choice, selection, and use of ST products and ST assumes no liability for application assistance or the design of Purchasers' products.

No license, express or implied, to any intellectual property right is granted by ST herein.

Resale of ST products with provisions different from the information set forth herein shall void any warranty granted by ST for such product.

ST and the ST logo are trademarks of ST. All other product or service names are the property of their respective owners.

Information in this document supersedes and replaces information previously supplied in any prior versions of this document.

© 2015 STMicroelectronics – All rights reserved



## X-ON Electronics

Largest Supplier of Electrical and Electronic Components

*Click to view similar products for [ESD Suppressors / TVS Diodes](#) category:*

*Click to view products by [STMicroelectronics](#) manufacturer:*

Other Similar products are found below :

[60KS200C](#) [D12V0H1U2WS-7](#) [D18V0L1B2LP-7B](#) [82356050220](#) [D5V0M5U6V-7](#) [NTE4902](#) [P4KE27CA](#) [P6KE11CA](#) [P6KE39CA-TP](#)  
[P6KE8.2A](#) [SA110CA](#) [SA60CA](#) [SA64CA](#) [SMBJ12CATR](#) [SMBJ8.0A](#) [SMLJ30CA-TP](#) [ESD101-B1-02ELS E6327](#) [ESD112-B1-02EL E6327](#)  
[ESD119B1W01005E6327XTSA1](#) [ESD5V0J4-TP](#) [ESD5V0L1B02VH6327XTSA1](#) [ESD7451N2T5G](#) [19180-510](#) [CPDT-5V0USP-HF](#)  
[3.0SMCJ33CA-F](#) [3.0SMCJ36A-F](#) [HSPC16701B02TP](#) [D3V3Q1B2DLP3-7](#) [D55V0M1B2WS-7](#) [DESD5V0U1BL-7B](#) [DRTR5V0U4SL-7](#)  
[SCM1293A-04SO](#) [ESD200-B1-CSP0201 E6327](#) [ESD203-B1-02EL E6327](#) [SM12-7](#) [SMF8.0A-TP](#) [SMLJ45CA-TP](#) [CEN955 W/DATA](#)  
[82350120560](#) [82356240030](#) [VESD12A1A-HD1-GS08](#) [CPDUR5V0R-HF](#) [CPDUR24V-HF](#) [CPDQC5V0U-HF](#) [CPDQC5V0USP-HF](#)  
[CPDQC5V0-HF](#) [D1213A-01LP4-7B](#) [D1213A-02WL-7](#) [ESDLIN1524BJ-HQ](#) [5KP100A](#)