

## Common mode filter with ESD protection for USB2.0 interface

Datasheet - production data

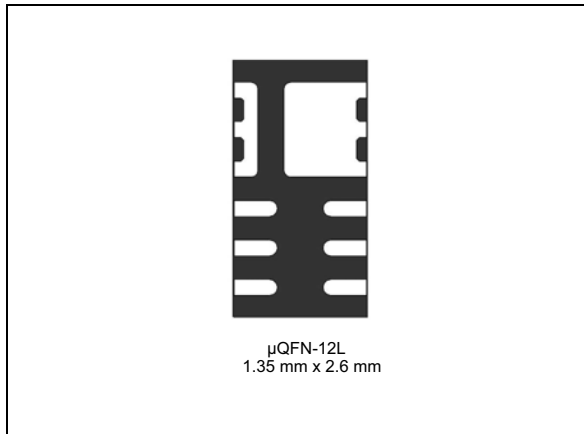
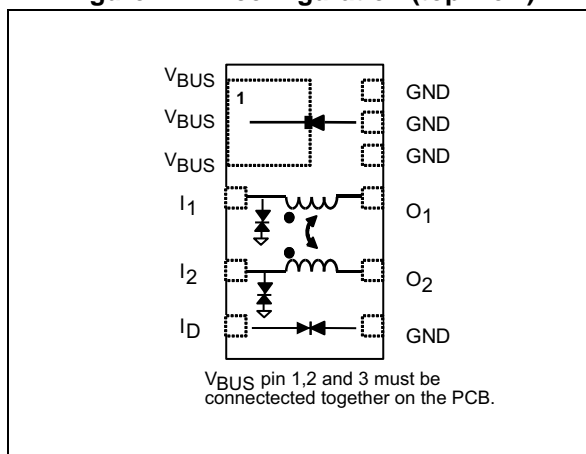


Figure 1. Pin configuration (top view)



### Features

- High common mode attenuation from 0.65 GHz to 3 GHz:
  - -18 dB at 0.7 GHz
  - -30 dB at 0.9 GHz
  - -25 dB at 1.5 GHz
  - -20 dB at 2.4 GHz
  - -17 dB at 3 GHz

- $V_{BUS}$  high power TVS diode:
  - $V_{RM} = 13.2\text{ V}$
  - $I_{PP} (8/20\ \mu\text{s}): 70\text{ A}$
- Very low PCB space consumption
- Thin package: 0.55 mm max
- Lead free package
- High reduction of parasitic elements through integration

### Complies with following standards

- IEC61000-4-2 level 4:
  - +/-15 kV (air discharge)
  - +/-8 kV (contact discharge)

### Applications

- Mobile phone, smartphone
- Phablet
- Tablet
- Portable devices

### Description

The ECMF2-0730V12M12 is a highly integrated common mode filter designed to suppress EMI/RFI common mode noise on LTE, GSM and GPS band. The device integrates a high power TVS to protect the  $V_{BUS}$  line against surge.

# 1 Characteristics

**Table 1. Absolute maximum rating ( $T_{amb} = 25\text{ }^{\circ}\text{C}$ )**

Symbol	Parameter		Value	Unit
$V_{PP}$	Peak pulse voltage	$I_1, I_2, O_1, O_2, I_D$	IEC61000-4-2 contact discharge 8 IEC61000-4-2 air discharge 15	kV
		$V_{BUS}$	IEC61000-4-2 contact discharge 30 IEC61000-4-2 air discharge 30	kV
	$I_{PP}$	Peak pulse current (8/20 $\mu\text{s}$ )		70 A
	$P_{PP}$	Peak pulse power (8/20 $\mu\text{s}$ )		1500 W
$I_{RMS}$	Maximum RMS current		100 mA	
$T_{OP}$	Operating temperature		-40 to +85 $^{\circ}\text{C}$	
$T_j$	Maximum junction temperature		125 $^{\circ}\text{C}$	
$T_{stg}$	Storage temperature range		-65 to +150 $^{\circ}\text{C}$	
$T_L$	Maximum lead temperature for soldering during 10 s		260 $^{\circ}\text{C}$	

**Figure 2.  $V_{BUS}$  pins electrical characteristics (definitions)**

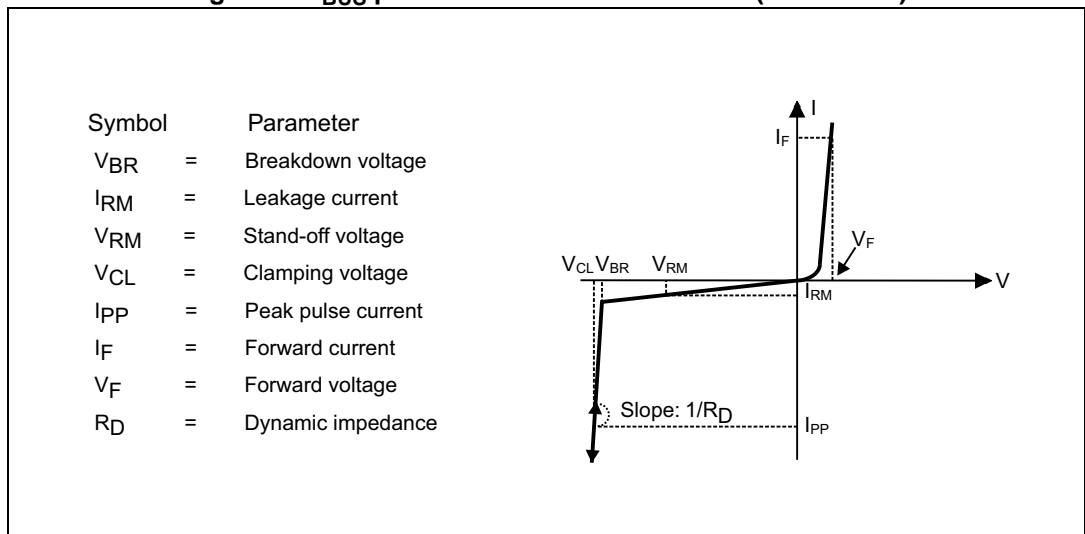


Figure 3. I<sub>1</sub>, I<sub>2</sub> and I<sub>D</sub> pins electrical characteristics (definitions)

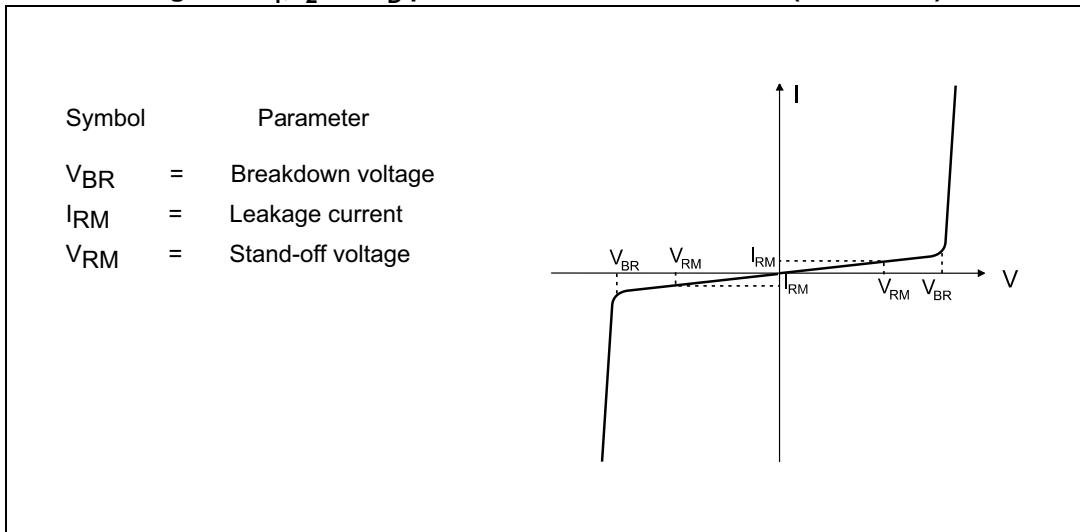
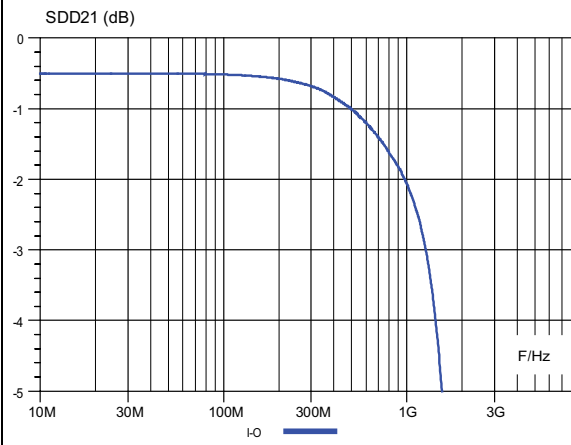


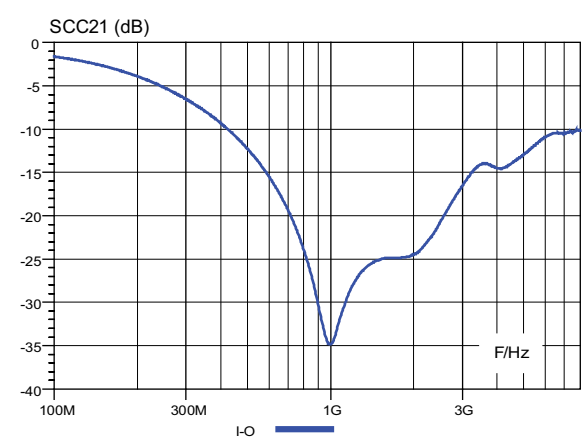
Table 2. Electrical characteristics (T<sub>amb</sub> = 25°C)

Symbol	Test conditions	Min.	Typ.	Max.	Unit
Data Lines					
V <sub>BR</sub>	I <sub>R</sub> = 1 mA	5			V
I <sub>RM</sub>	V <sub>RM</sub> = 3 V per line			100	nA
R <sub>DC</sub>	DC serial resistance		5.5		Ω
F <sub>c</sub>	Differential mode cut-off frequency at -3 dB		1.2		GHz
I <sub>D</sub>					
V <sub>BR</sub>	I <sub>R</sub> = 1 mA	5			V
I <sub>RM</sub>	V <sub>RM</sub> = 3 V			100	nA
V <sub>BUS</sub>					
V <sub>BR</sub>	I <sub>R</sub> = 1 mA	13.5			V
I <sub>RM</sub>	V <sub>RM</sub> = 13.2 V		0.1	1	μA
V <sub>CL</sub>	I <sub>PP</sub> = 60 A - 8/20 μs		21	23	V
R <sub>D</sub>	8/20 μs		0.1		Ω

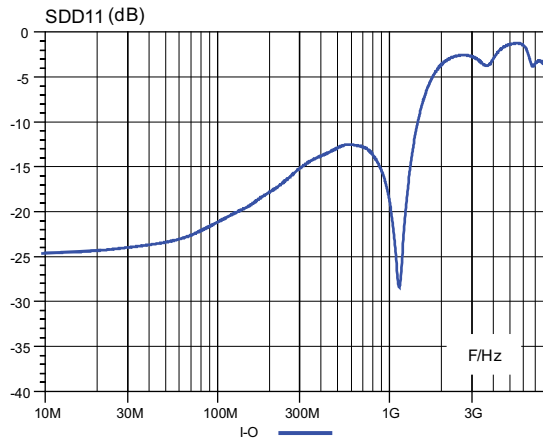
**Figure 4. Differential mode attenuation versus frequency ( $Z_{0\text{ diff}} = 100 \Omega$ )**



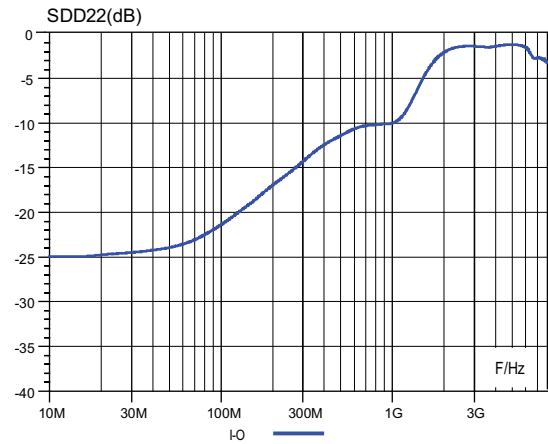
**Figure 5. Common mode attenuation versus frequency ( $Z_{0\text{ com}} = 50 \Omega$ )**



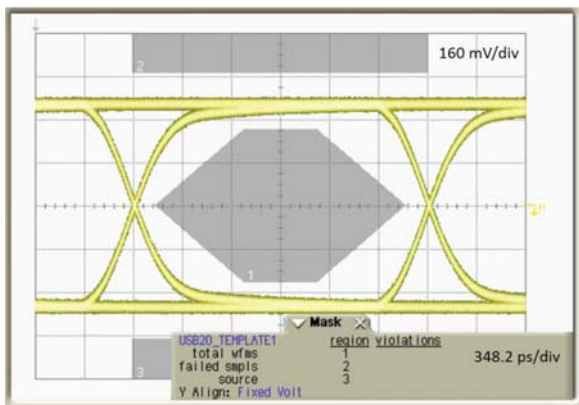
**Figure 6. Return loss versus frequency ( $Z_{0\text{ com}} = 50 \Omega$ )**



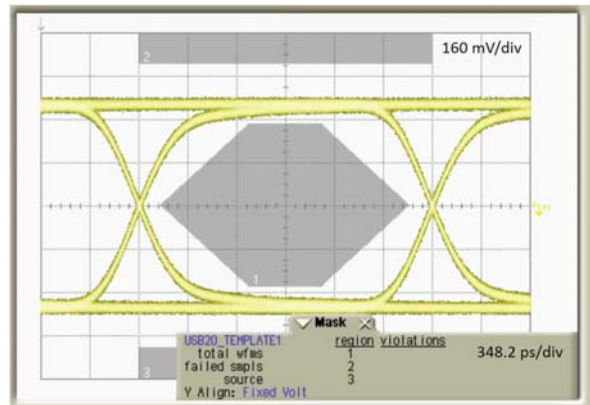
**Figure 7. Return loss versus frequency ( $Z_{0\text{ com}} = 50 \Omega$ )**

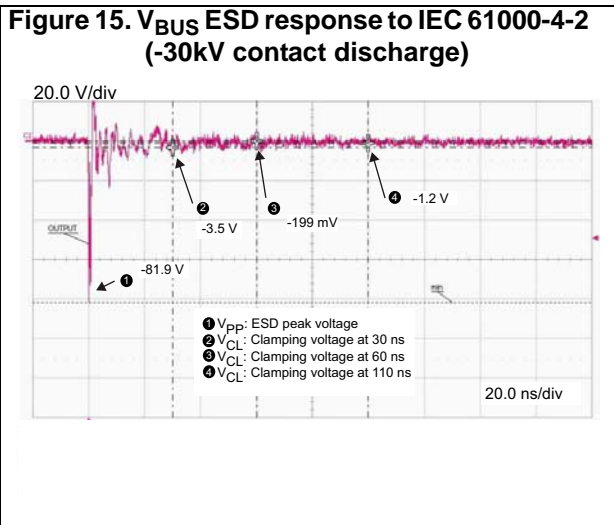
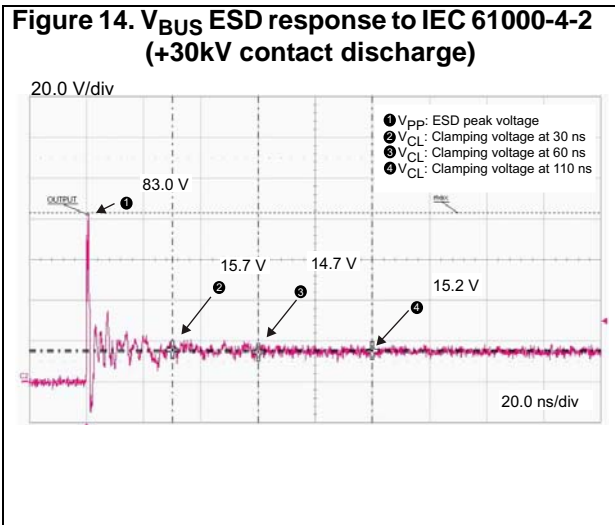
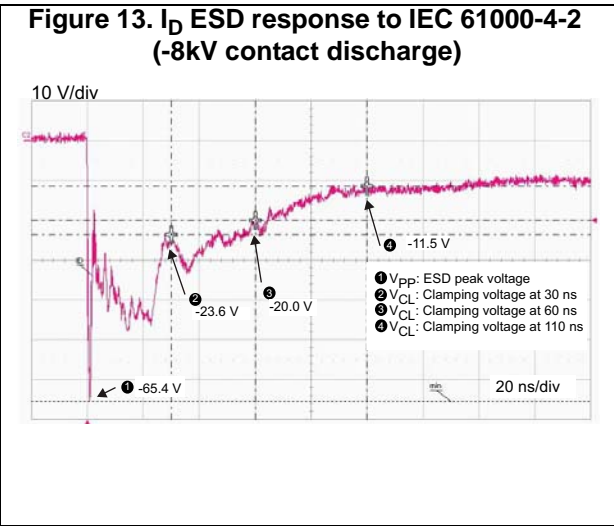
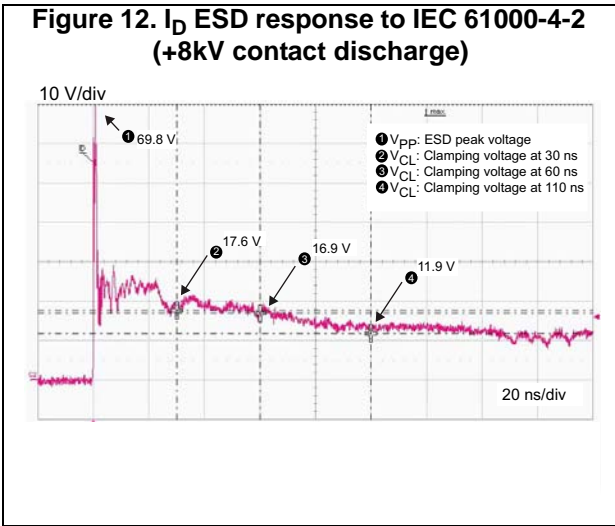
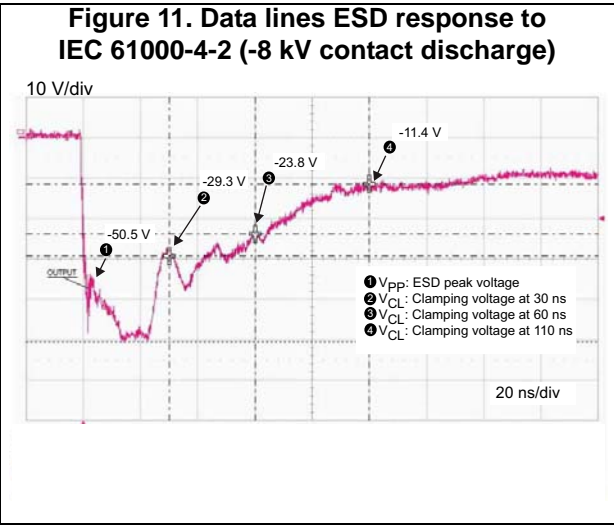
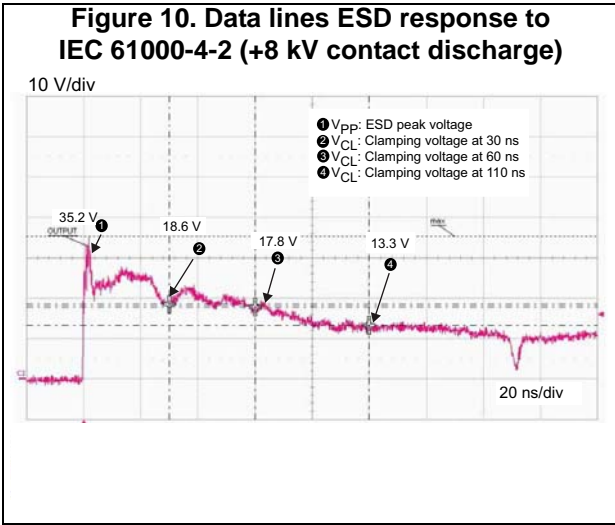


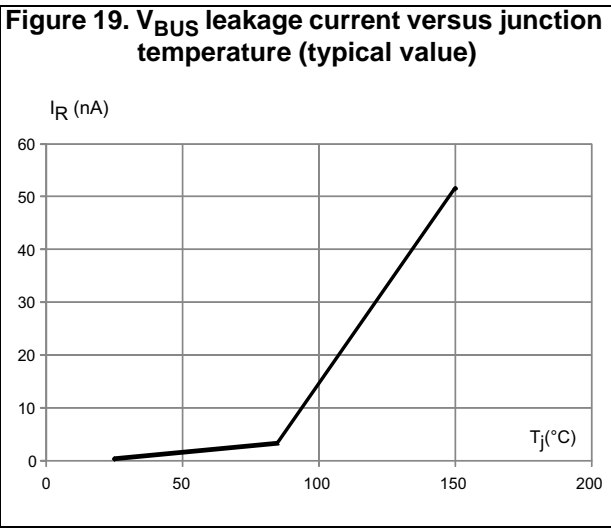
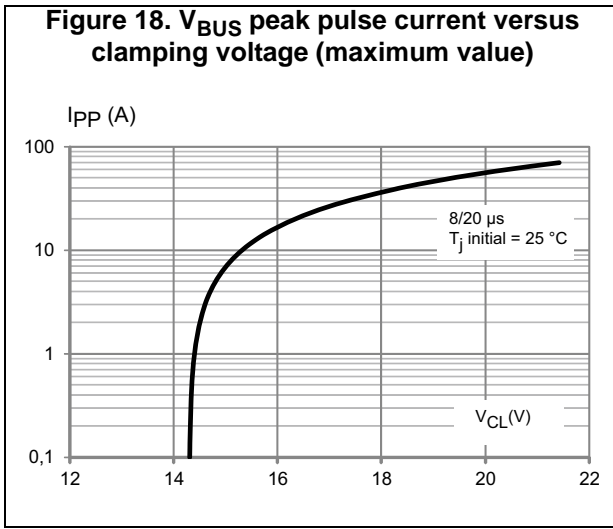
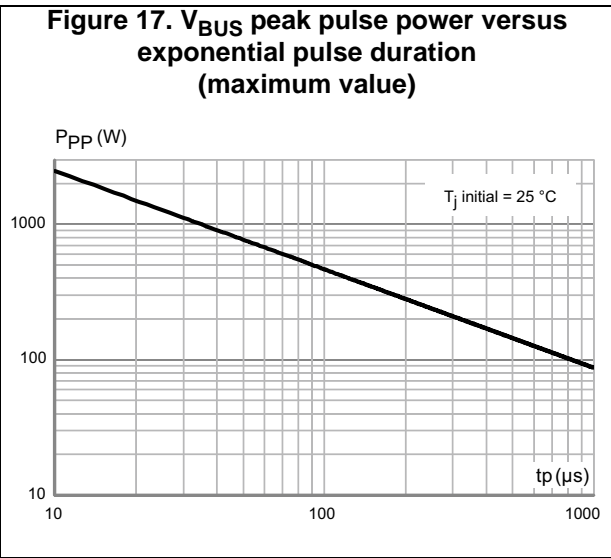
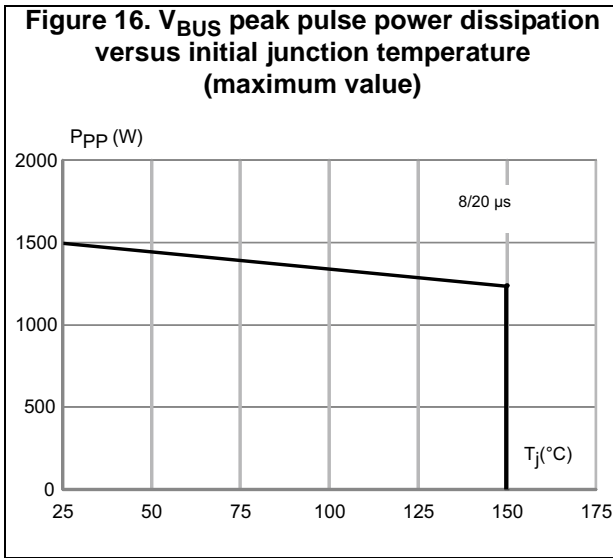
**Figure 8. USB2.0 (480 Mbps) eye diagram without device**



**Figure 9. USB2.0 (480 Mbps) eye diagram with device**







## 2 Package information

In order to meet environmental requirements, ST offers these devices in different grades of ECOPACK<sup>®</sup> packages, depending on their level of environmental compliance. ECOPACK<sup>®</sup> specifications, grade definitions and product status are available at: [www.st.com](http://www.st.com). ECOPACK<sup>®</sup> is an ST trademark.

### 2.1 $\mu$ QFN-12L package information

Figure 20.  $\mu$ QFN-12L package outline

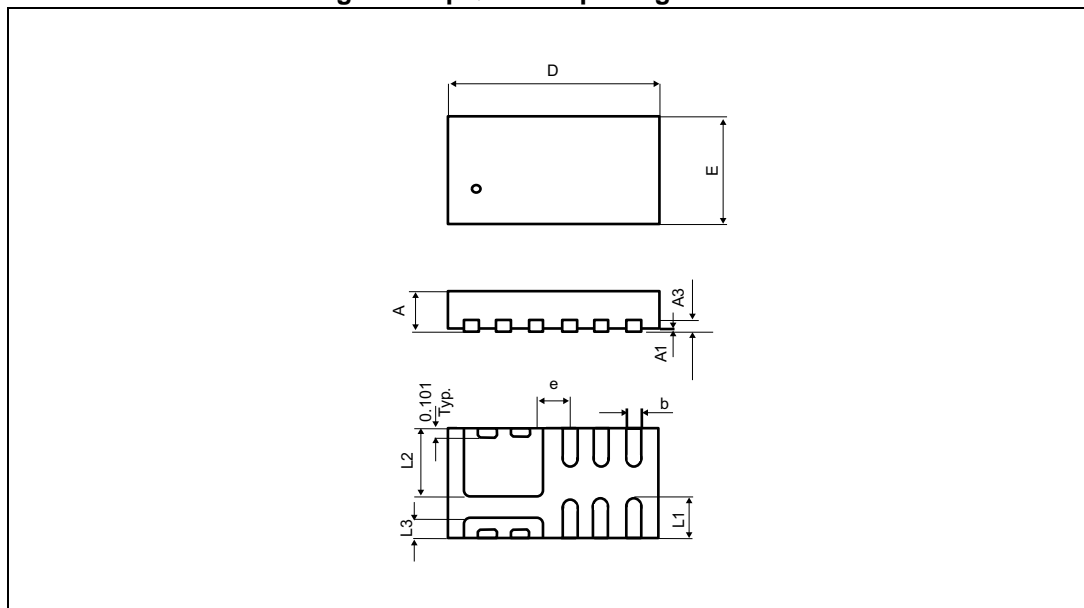
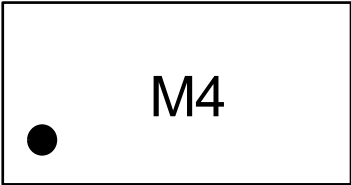
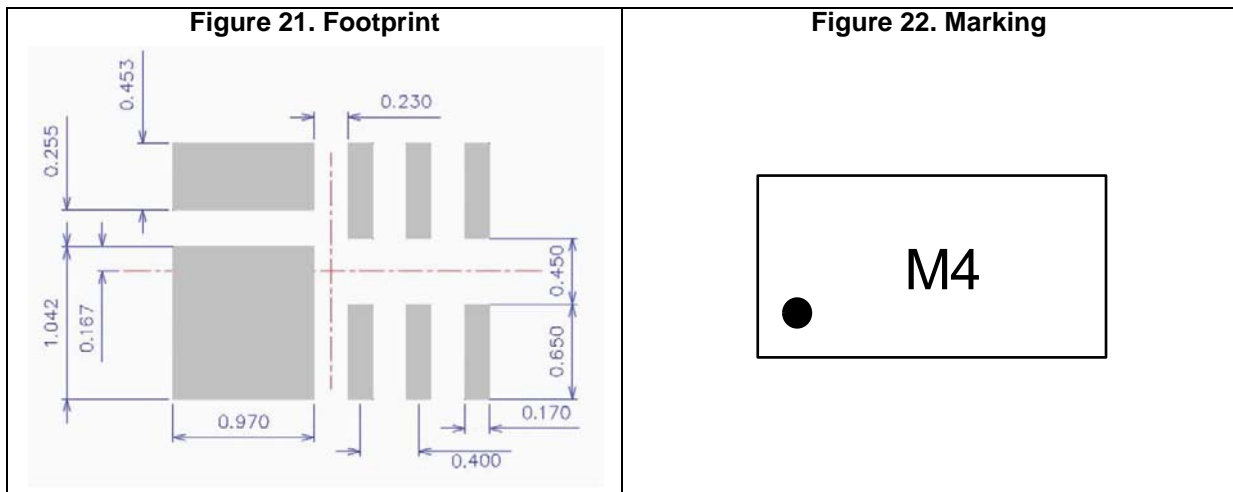


Table 3.  $\mu$ QFN-12L package mechanical data

Ref.	Dimensions					
	Millimeters			Inches <sup>(1)</sup>		
	Typ.	Min.	Max.	Typ.	Min.	Max.
A	0.50	0.45	0.55	0.0197	0.0177	0.0217
A1	0.02	0.00	0.05	0.0008	0.0000	0.0020
A3	0.127			0.0050		
b	0.20	0.15	0.25	0.0079	0.0060	0.0099
D	2.60	2.55	2.65	0.102	0.100	0.1043
E	1.35	1.30	1.40	0.0531	0.0512	0.0551
e	0.40			0.0157		
L1	0.45	0.35	0.55	0.0177	0.0138	0.0217
L2	0.842	0.742	0.942	0.0331	0.0292	0.0371
L3	0.253	0.153	0.353	0.0099	0.0060	0.0139

1. Values in inches are converted from mm and rounded to 4 decimal digits.



Note: The marking codes can be rotated by 90 ° or 180 ° to differentiate assembly location. In no case should this product marking be used to orient the component for its placement on a PCB. Only pin 1 mark is to be used for this purpose





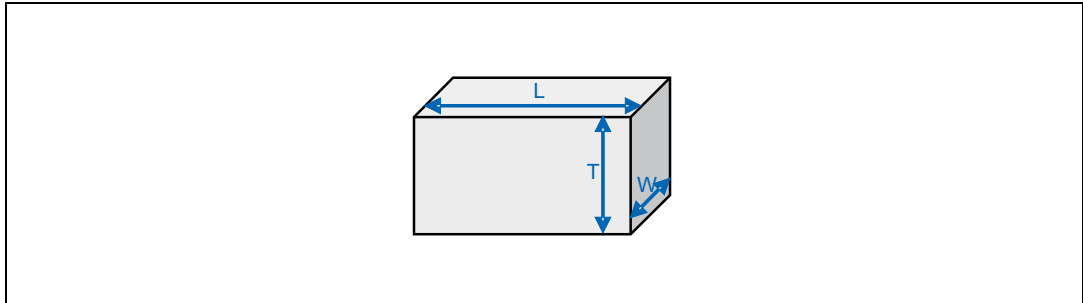
### 3 Recommendation on PCN assembly

#### 3.1 Stencil opening design

##### 3.1.1 General recommendation on stencil opening design

1. Stencil opening dimensions: L (Length), W (Width), T (Thickness).

Figure 24. Stencil opening recommendation



2. General design rule

Stencil thickness (T) = 75 ~ 125 μm

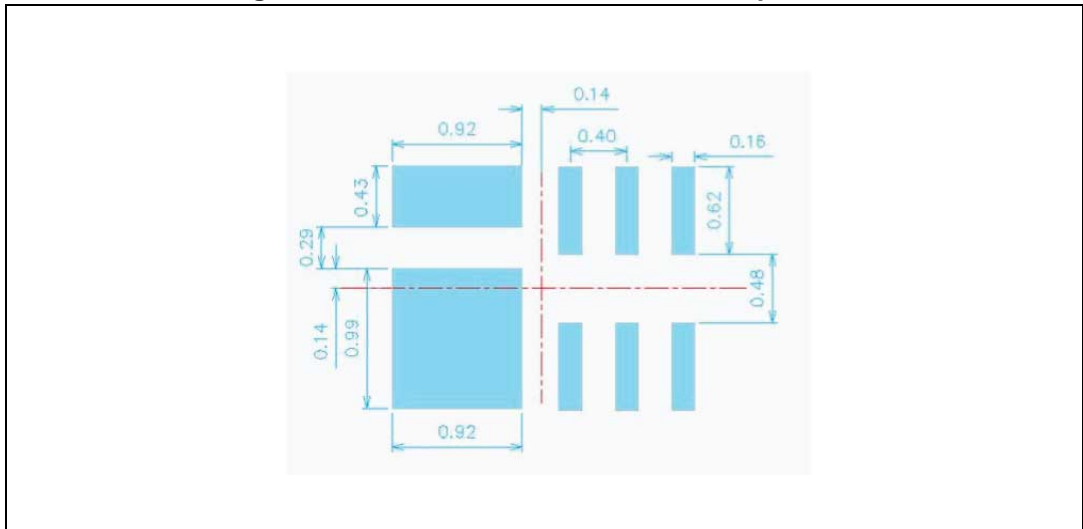
$$\text{Aspect ratio} = \frac{W}{T} \geq 1.5$$

$$\text{Aspect area} = \frac{L \times W}{2T(L+W)} \geq 0.66$$

##### 3.1.2 Reference design

1. Stencil opening thickness: 100 μm
2. Stencil opening for leads: opening to footprint ratio is 90%.

Figure 25. Recommended stencil window position



### 3.2 Solder paste

1. Use halide-free flux, qualification ROL0 according to ANSI/J-STD-004.
2. "No clean" solder paste recommended.
3. Offers a high tack force to resist component displacement during PCB movement.
4. Use solder paste with fine particles: powder particle size 20-45  $\mu\text{m}$ .

### 3.3 Placement

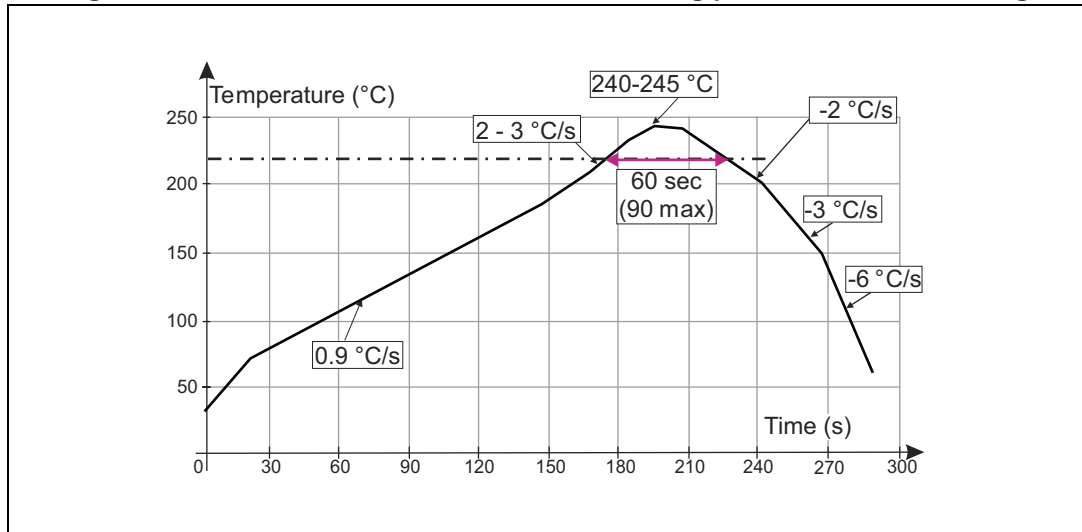
1. Manual positioning is not recommended.
2. It is recommended to use the lead recognition capabilities of the placement system, not the outline centering.
3. Standard tolerance of  $\pm 0.05$  mm is recommended.
4. 3.5N placement force is recommended. Too much placement force can lead to squeezed out solder paste and cause solder joints to short. Too low placement force can lead to insufficient contact between package and solder paste that could cause open solder joints or badly centered packages.
5. To improve the package placement accuracy, a bottom side optical control should be performed with a high resolution tool.
6. For assembly, a perfect supporting of the PCB (all the more on flexible PCB) is recommended during solder paste printing, pick and place and reflow soldering by using optimized tools.

### 3.4 PCB design preference

1. To control the solder paste amount, the closed via is recommended instead of open vias.
2. The position of tracks and open vias in the solder area should be well balanced. The symmetrical layout is recommended, in case any tilt phenomena caused by asymmetrical solder paste amount due to the solder flow away

### 3.5 Reflow profile

Figure 26. ST ECOPACK® recommended soldering profile for PCB mounting



Note: Minimize air convection currents in the reflow oven to avoid component movement.

#### 3.5.1 General advice about reflow conditions:

For each individual board, the appropriate heat profile has to be adjusted experimentally. The proposed profiles are just starting points. In every case, the following precautions have to be considered:

- Always preheat the device. The purpose of this step is to minimize the rate of temperature rise to less than 2 °C per second in order to minimize thermal shock on the component.
- Dry out sections ensure that the solder paste is fully dried before starting reflow step. Also, this step allows the temperature gradient on the board to be evened out.
- Peak temperature should be at least 30 °C higher than the melting point of the chosen solder alloy to ensure the reflow quality. In any case the peak temperature should not exceed 260 °C.

## 4 Ordering information

Figure 27. Ordering information scheme

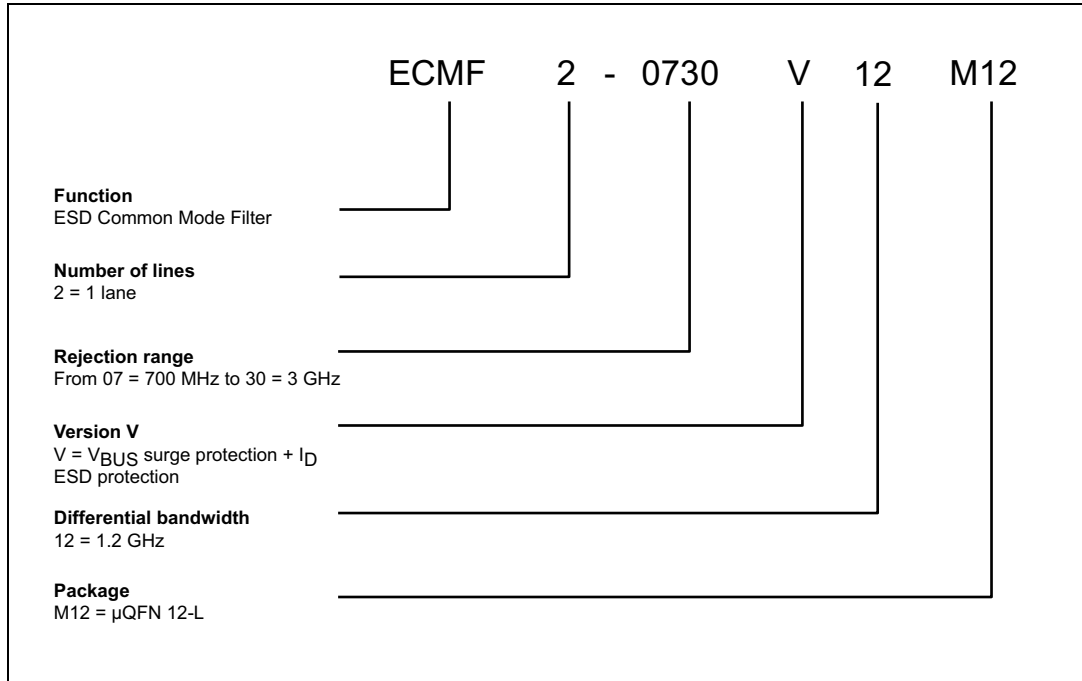


Table 4. Ordering information

Order code	Marking	Package	Weight	Base qty.	Delivery mode
ECMF2-0730V12M12	M4	μQFN-12L	5.3 mg	3000	Tape and reel

## 5 Revision history

Table 5. Document revision history

Date	Revision	Changes
01-Mar-2016	1	Initial release.

**IMPORTANT NOTICE – PLEASE READ CAREFULLY**

STMicroelectronics NV and its subsidiaries ("ST") reserve the right to make changes, corrections, enhancements, modifications, and improvements to ST products and/or to this document at any time without notice. Purchasers should obtain the latest relevant information on ST products before placing orders. ST products are sold pursuant to ST's terms and conditions of sale in place at the time of order acknowledgement.

Purchasers are solely responsible for the choice, selection, and use of ST products and ST assumes no liability for application assistance or the design of Purchasers' products.

No license, express or implied, to any intellectual property right is granted by ST herein.

Resale of ST products with provisions different from the information set forth herein shall void any warranty granted by ST for such product.

ST and the ST logo are trademarks of ST. All other product or service names are the property of their respective owners.

Information in this document supersedes and replaces information previously supplied in any prior versions of this document.

© 2016 STMicroelectronics – All rights reserved

## X-ON Electronics

Largest Supplier of Electrical and Electronic Components

*Click to view similar products for [ESD Suppressors / TVS Diodes](#) category:*

*Click to view products by [STMicroelectronics](#) manufacturer:*

Other Similar products are found below :

[60KS200C](#) [D12V0H1U2WS-7](#) [D18V0L1B2LP-7B](#) [82356050220](#) [D5V0M5U6V-7](#) [NTE4902](#) [P4KE27CA](#) [P6KE11CA](#) [P6KE39CA-TP](#)  
[P6KE8.2A](#) [SA110CA](#) [SA60CA](#) [SA64CA](#) [SMBJ12CATR](#) [SMBJ8.0A](#) [SMLJ30CA-TP](#) [ESD101-B1-02ELS E6327](#) [ESD112-B1-02EL E6327](#)  
[ESD119B1W01005E6327XTSA1](#) [ESD5V0J4-TP](#) [ESD5V0L1B02VH6327XTSA1](#) [ESD7451N2T5G](#) [19180-510](#) [CPDT-5V0USP-HF](#)  
[3.0SMCJ33CA-F](#) [3.0SMCJ36A-F](#) [HSPC16701B02TP](#) [D3V3Q1B2DLP3-7](#) [D55V0M1B2WS-7](#) [DESD5V0U1BL-7B](#) [DRTR5V0U4SL-7](#)  
[SCM1293A-04SO](#) [ESD200-B1-CSP0201 E6327](#) [ESD203-B1-02EL E6327](#) [SM12-7](#) [SMF8.0A-TP](#) [SMLJ45CA-TP](#) [CEN955 W/DATA](#)  
[82350120560](#) [82356240030](#) [VESD12A1A-HD1-GS08](#) [CPDUR5V0R-HF](#) [CPDUR24V-HF](#) [CPDQC5V0U-HF](#) [CPDQC5V0USP-HF](#)  
[CPDQC5V0-HF](#) [D1213A-01LP4-7B](#) [D1213A-02WL-7](#) [ESDLIN1524BJ-HQ](#) [5KP100A](#)