

Automotive 5 V TVS in SOD323



SOD323
(Jedec DO-215)



Features

- AEC-Q101 qualified 
- Unidirectional devices
- **ECOPACK2** compliant component
- ISO 10605 / IEC 61000-4-2: C = 150 pF, R = 330 Ω , exceeds level 4
 - ± 30 kV (air discharge)
 - ± 30 kV (contact discharge)
- ISO 10605: C = 330 pF, R = 330 Ω , exceeds level 4
 - ± 30 kV (air discharge)
 - ± 30 kV (contact discharge)
- IEC 61000-4-4
- ISO 7637-3
 - Fast transient pulse a: $V_s = -150$ V
 - Fast transient pulse b: $V_s = +150$ V
 - Slow transient negative pulse: $V_s = -85$ V
 - Slow transient positive pulse: $V_s = +85$ V

Application

Protection of electronic circuits in ICE vehicles, electrical vehicle and hybrid electric vehicles such as e-bikes, cars and buses. The low clamping voltage during ESD and EOS surges provides an efficient protection of the equipment to ensure robustness and longevity of the vehicle.

Description

This ESDA051-1JY is unidirectional single TVS protection devices designed to protect sensitive equipment against ESD transients and EOS surges.

This device is packaged in SOD323.

Product status link

[ESDA051-1JY](#)

1 Characteristics

Table 1. Absolute maximum ratings ($T_{amb} = 25\text{ }^{\circ}\text{C}$)

Symbol	Parameter	Value	Unit	
V_{PP}	Peak pulse voltage	ISO10605 / IEC 61000-4-2 (C = 150 pF, R = 330 Ω):	kV	
		Contact discharge		30
		Air discharge		30
		ISO10605 (C = 330 pF, R = 330 Ω):		30
		Contact discharge		
Air discharge				
ISO 10605 - C = 330 pF, R = 2 k Ω	30			
I_{PP}	Peak pulse current	8/20 μs	A	
T_j	Operating junction temperature range	-55 to +150	$^{\circ}\text{C}$	
T_{stg}	Storage temperature range	-55 to +150	$^{\circ}\text{C}$	
T_L	Maximum lead temperature for soldering during 10 s	260	$^{\circ}\text{C}$	

Figure 1. Electrical characteristics - parameter definitions

V_{RM} Maximum stand-off voltage
 I_{RM} Maximum leakage current @ V_{RM}
 V_{BR} Breakdown voltage @ I_{BR}
 I_{BR} Breakdown current
 V_{CL} Clamping voltage @ I_{PP}
 I_{PP} Peak pulse current
 R_D Dynamic resistance
 V_F Forward voltage drop @ I_F
 I_F Forward current
 αT Voltage temperature coefficient

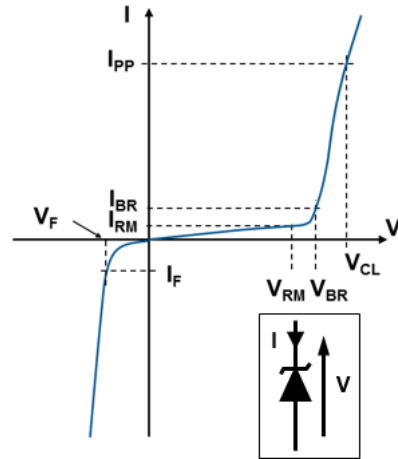
Table 2. Electrical characteristics - parameter values ($T_{amb} = 25\text{ }^{\circ}\text{C}$, unless otherwise specified)

Type	I_{RM} at V_{RM}		V_{BR} at 1 mA			V_F at 10 mA		8 / 20 μs			C at 0 V
	Max.		Min.	Typ.	Max.	Typ.	Max.	$V_{CL}^{(1)}$	I_{PP}	R_D	Typ.
	μA	V	V	V	V	V	V	V	A	Ω	pF
ESDA051-1JY	3	5	6.2	6.5	6.8	0.78	0.9	12.8	20	0.3	190

 1. To calculate V_{CL} max versus I_{PP} appli: $V_{CL} \text{ max} = V_{BR} \text{ max} + R_D \times I_{PP} \text{ appli}$.

1.1 Characteristics (curves)

Figure 2. Maximum peak current dissipation versus initial junction temperature

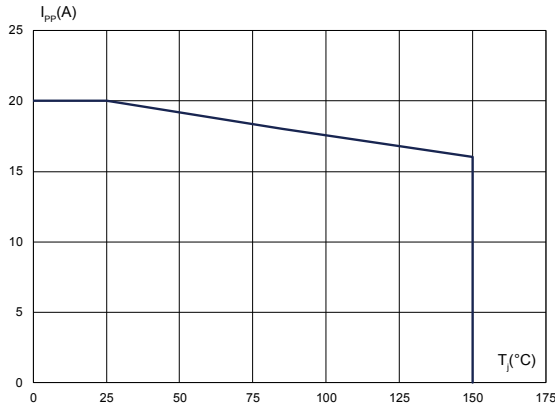

Figure 3. Maximum peak pulse current versus exponential pulse duration

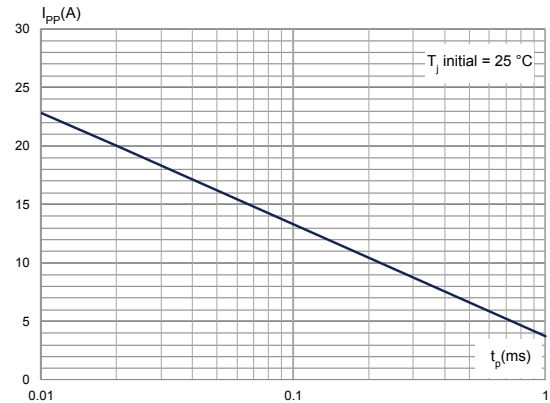

Figure 4. Peak pulse current versus clamping voltage

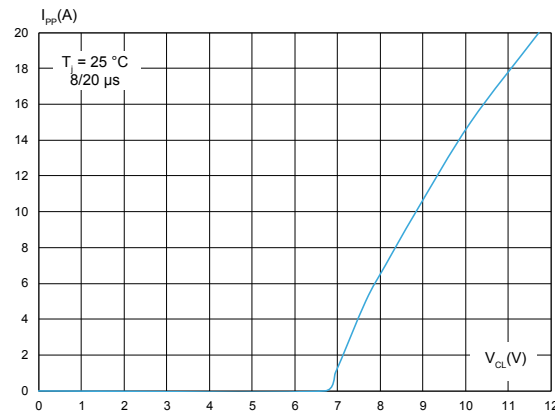

Figure 5. Leakage current versus junction temperature

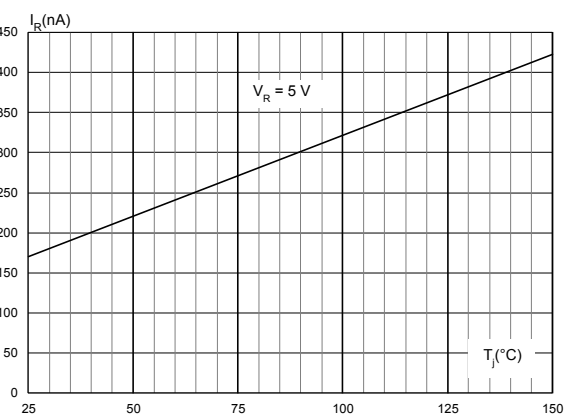

Figure 6. Leakage current versus reverse voltage

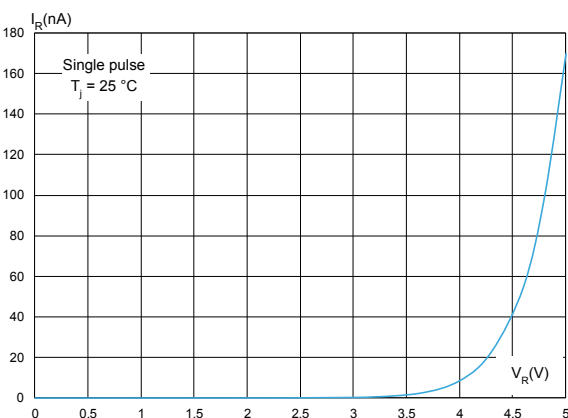

Figure 7. Forward current versus forward voltage drop

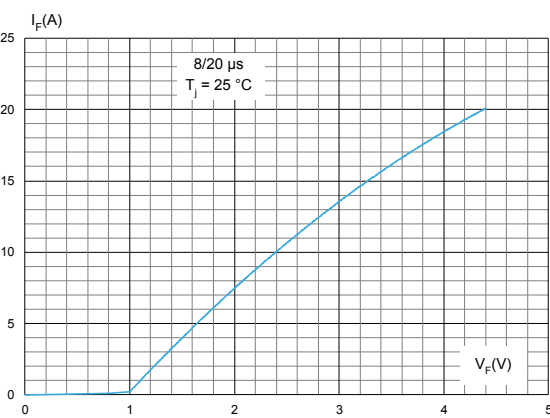

Figure 8. Response to ISO 10605 -C = 150 pF, R = 330 Ω (-8 kV contact)

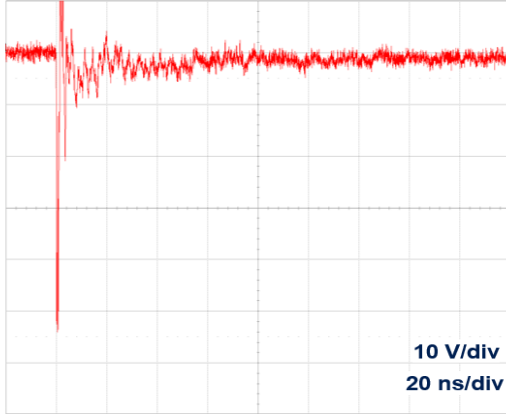

Figure 9. Response to ISO 10605 -C = 150 pF, R = 330 Ω (+8 kV contact)

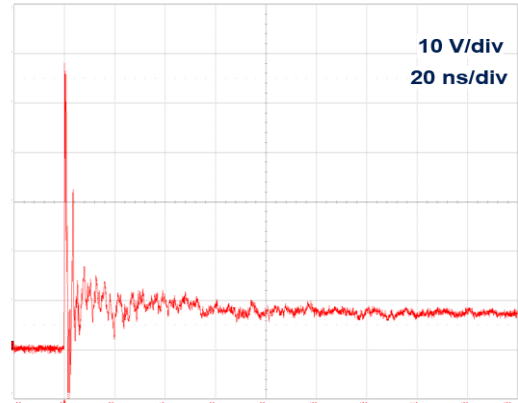

Figure 10. Response to ISO 7637-3 fast transient pulse a: -150 V

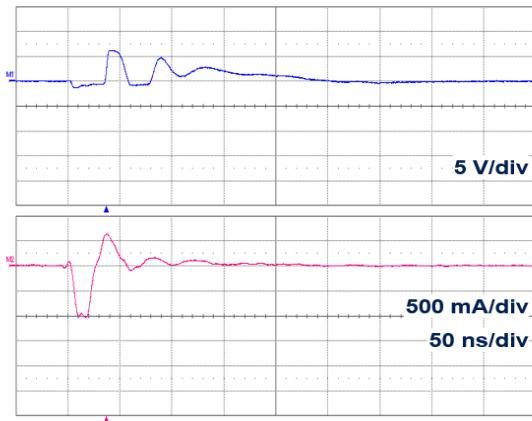

Figure 11. Response to ISO 7637-3 fast transient pulse b: +150 V

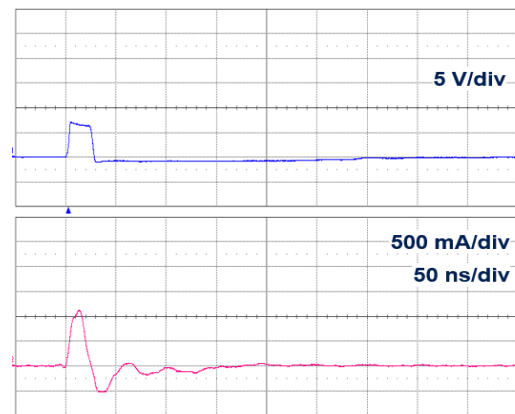

Figure 12. Response to ISO 7637-3 slow transient negative pulse: -85 V

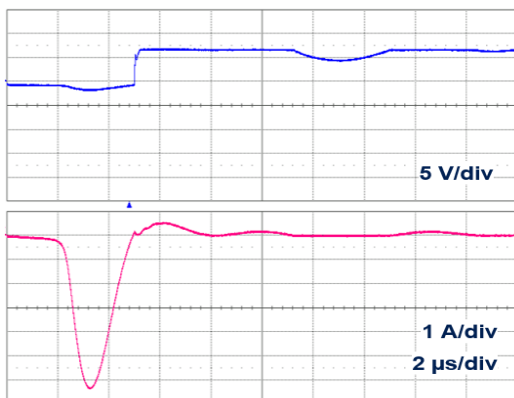

Figure 13. Response to ISO 7637-3 slow transient positive pulse: +85 V

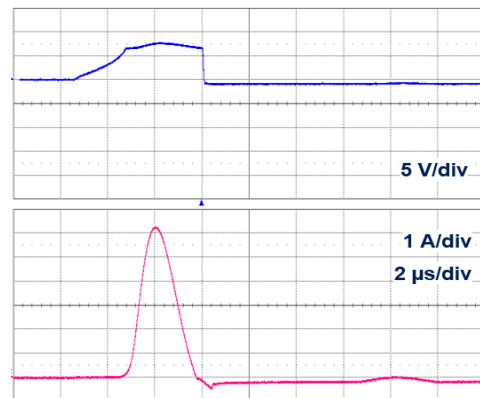
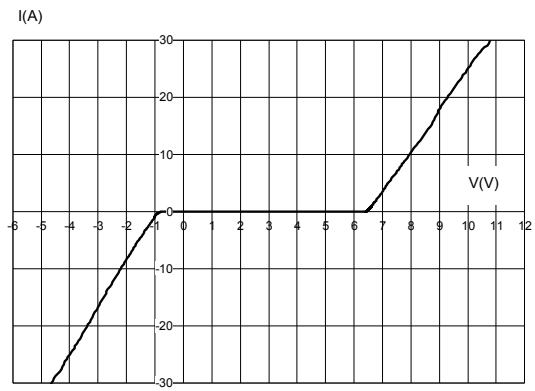

Figure 14. TLP



2 Package information

In order to meet environmental requirements, ST offers these devices in different grades of **ECOPACK** packages, depending on their level of environmental compliance. ECOPACK specifications, grade definitions and product status are available at: www.st.com. ECOPACK is an ST trademark.

2.1 SOD323 package information

Figure 15. SOD323 package outline

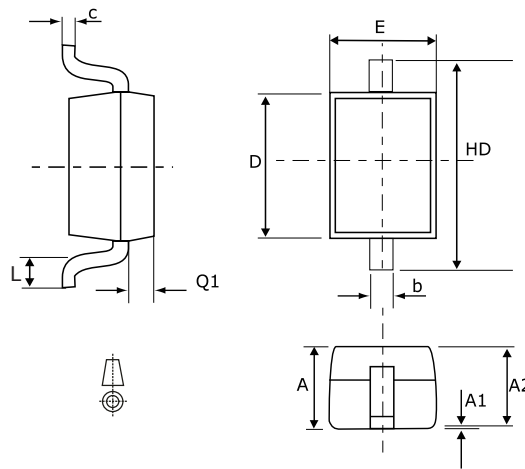

Table 3. SOD323 package mechanical data

Ref.	Dimensions			
	Millimeters		Inches ⁽¹⁾	
	Min.	Max.	Min.	Max.
A		1.17		0.046
A1	0.00	0.10	0.000	0.004
A2				
b	0.25	0.44	0.010	0.018
c	0.10	0.25	0.003	0.010
D	1.52	1.80	0.059	0.071
E	1.11	1.45	0.043	0.058
HD	2.30	2.70	0.090	0.107
L	0.10	0.46	0.003	0.019
Q1	0.10	0.41	0.003	0.017

1. Values in inches are converted from mm and rounded to 3 decimal digits

2.2 SOD323 packing information

Figure 16. SOD323 footprint in mm

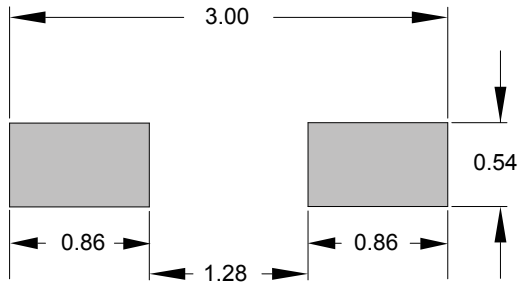
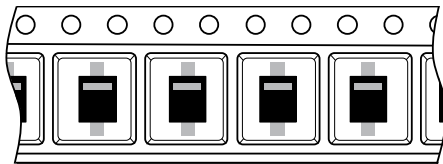

Figure 17. SOD323 marking



Figure 18. Package orientation in reel



Taped according to EIA-481
Note: Pocket dimensions are not on scale
Pocket shape may vary depending on package

Figure 19. Tape and reel orientation

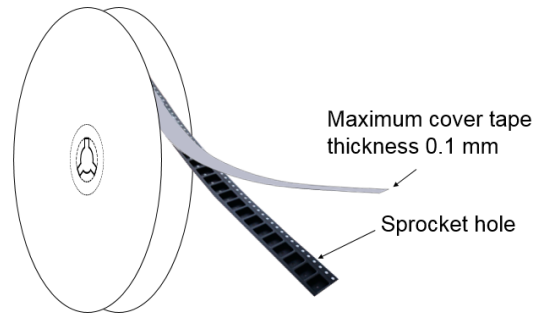

Figure 20. 7" reel dimension values

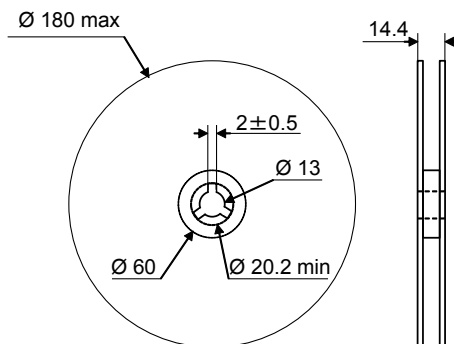

Figure 21. Inner box dimension values

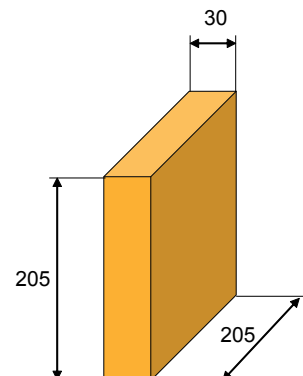
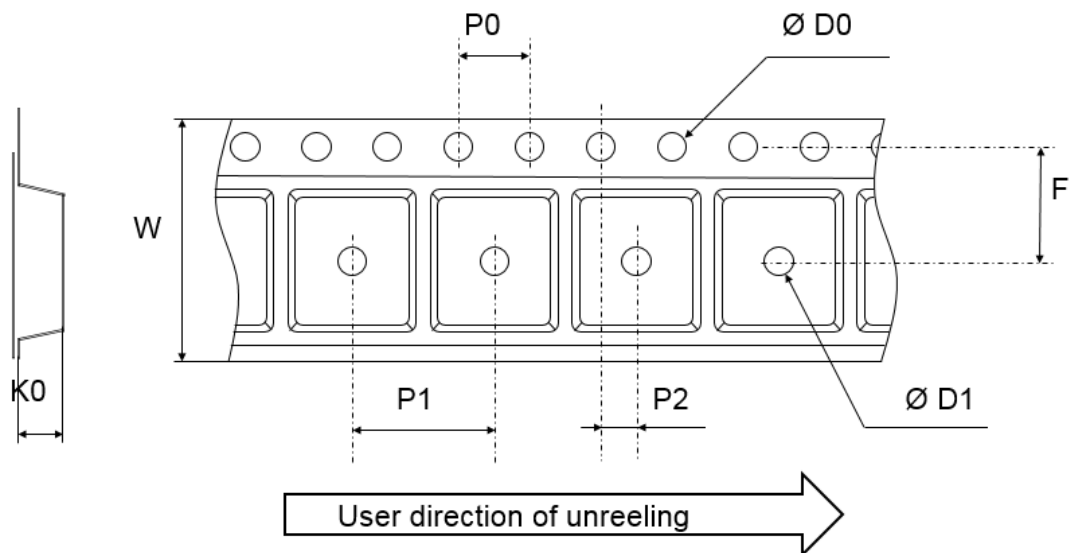

Figure 22. Tape outline



Note: Pocket dimensions are not on scale
Pocket shape may vary depending on package

Table 4. Tape dimension values

Ref.	Dimensions		
	Millimeters		
	Min.	Typ.	Max.
D0	1.50	1.55	1.6
D1	1.00		
F	3.45	3.50	3.55
K0	1.12	1.22	1.32
P0	3.90	4.00	4.10
P1	3.90	4.00	4.10
P2	1.95	2.00	2.05
W	7.90	8.00	8.30

2.3 Reflow profile

Figure 23. ST ECOPACK recommended soldering reflow profile for PCB mounting

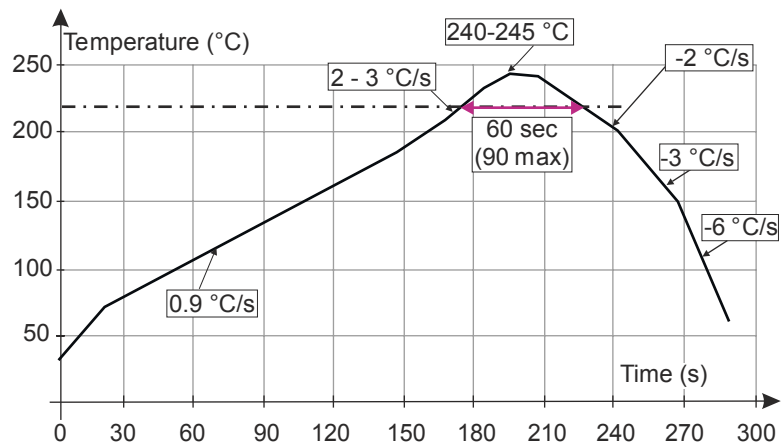

Note: Minimize air convection currents in the reflow oven to avoid component movement. Maximum soldering profile corresponds to the latest IPC/JEDEC J-STD-020.

2.4 Ordering information

Table 5. Ordering information

Order code	Marking	Package	Weight	Base qty.	Delivery mode
ESDA051-1JY	B5	SOD323	5.3 mg	3000	Tape and reel

Revision history

Table 6. Document revision history

Date	Revision	Changes
05-Nov-2019	1	Initial release.

IMPORTANT NOTICE – PLEASE READ CAREFULLY

STMicroelectronics NV and its subsidiaries (“ST”) reserve the right to make changes, corrections, enhancements, modifications, and improvements to ST products and/or to this document at any time without notice. Purchasers should obtain the latest relevant information on ST products before placing orders. ST products are sold pursuant to ST’s terms and conditions of sale in place at the time of order acknowledgement.

Purchasers are solely responsible for the choice, selection, and use of ST products and ST assumes no liability for application assistance or the design of Purchasers’ products.

No license, express or implied, to any intellectual property right is granted by ST herein.

Resale of ST products with provisions different from the information set forth herein shall void any warranty granted by ST for such product.

ST and the ST logo are trademarks of ST. For additional information about ST trademarks, please refer to www.st.com/trademarks. All other product or service names are the property of their respective owners.

Information in this document supersedes and replaces information previously supplied in any prior versions of this document.

© 2019 STMicroelectronics – All rights reserved

X-ON Electronics

Largest Supplier of Electrical and Electronic Components

Click to view similar products for [ESD Suppressors / TVS Diodes](#) category:

Click to view products by [STMicroelectronics](#) manufacturer:

Other Similar products are found below :

[60KS200C](#) [D12V0H1U2WS-7](#) [D18V0L1B2LP-7B](#) [82356050220](#) [D5V0M5U6V-7](#) [NTE4902](#) [P4KE27CA](#) [P6KE11CA](#) [P6KE39CA-TP](#)
[P6KE8.2A](#) [SA110CA](#) [SA60CA](#) [SA64CA](#) [SMBJ12CATR](#) [SMBJ8.0A](#) [SMLJ30CA-TP](#) [ESD101-B1-02ELS E6327](#) [ESD112-B1-02EL E6327](#)
[ESD119B1W01005E6327XTSA1](#) [ESD5V0J4-TP](#) [ESD5V0L1B02VH6327XTSA1](#) [ESD7451N2T5G](#) [19180-510](#) [CPDT-5V0USP-HF](#)
[3.0SMCJ33CA-F](#) [3.0SMCJ36A-F](#) [HSPC16701B02TP](#) [D3V3Q1B2DLP3-7](#) [D55V0M1B2WS-7](#) [DESD5V0U1BL-7B](#) [DRTR5V0U4SL-7](#)
[SCM1293A-04SO](#) [ESD200-B1-CSP0201 E6327](#) [ESD203-B1-02EL E6327](#) [SM12-7](#) [SMF8.0A-TP](#) [SMLJ45CA-TP](#) [CEN955 W/DATA](#)
[82350120560](#) [82356240030](#) [VESD12A1A-HD1-GS08](#) [CPDUR5V0R-HF](#) [CPDUR24V-HF](#) [CPDQC5V0U-HF](#) [CPDQC5V0USP-HF](#)
[CPDQC5V0-HF](#) [D1213A-01LP4-7B](#) [D1213A-02WL-7](#) [ESDLIN1524BJ-HQ](#) [5KP100A](#)