

Quad bidirectional Transil™ array for ESD protection

Features

- 2 bidirectional Transil functions
- ESD protection: IEC 61000-4-2 level 4
- Stand off voltage: 12 V Min.
- Low leakage current
- Very small PCB area < 1.5 mm²
- 400 microns pitch

Complies with the following standards

- IEC 61000-4-2
 - 15 kV (air discharge)
 - 8 kV (contact discharge)
- MIL STD 883E- Method 3015-7: class 3
 - 25 kV (human body model)

Applications

Where transient overvoltage protection in ESD sensitive equipment is required, such as:

- Computers
- Printers
- Communication systems and cellular phones
- Video equipment

Description

The ESDA14V2-2BF3 is a monolithic array designed to protect 2 lines against ESD transients. The device is ideal for applications where both reduced line capacitance and board space saving are required.

This device is particularly adapted to the protection of symmetrical signals.

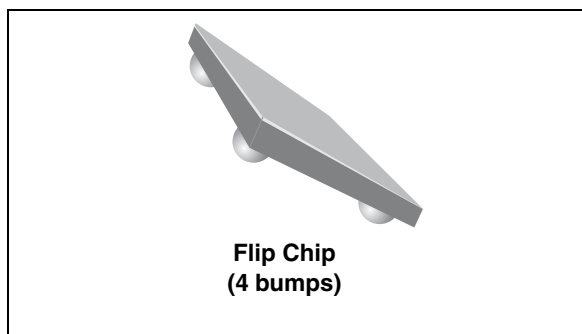

Figure 1. Pin layout (bump side)

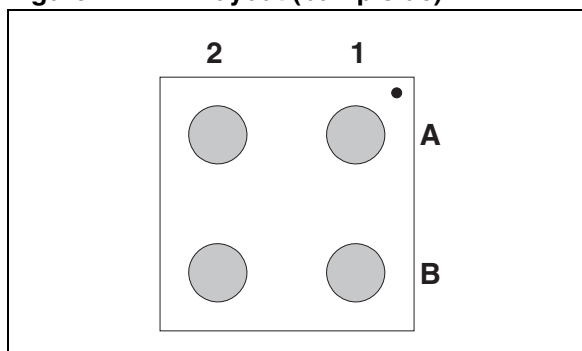
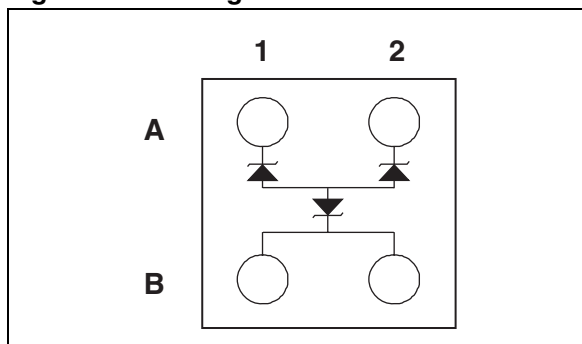

Figure 2. Configuration



TM: Transil is ASD a trademark of STMicroelectronics.

1 Characteristics

Table 1. Absolute ratings (limiting values)

Symbol	Parameter	Value	Unit
V _{PP}	MIL STD 883E - Method 3015-7	± 25	kV
	ESD discharge IEC 61000-4-2 air discharge	± 15	
	IEC 61000-4-2 contact discharge	± 8	
P _{PP}	Peak pulse power (8/20µs)	50	W
T _j	Junction temperature	125	°C
T _{stg}	Storage temperature range	-55 to +150	°C
T _L	Lead solder temperature (10 seconds duration)	260	°C
T _{op}	Operating temperature range	-40 to +125	°C

Table 2. Electrical characteristics (T_{amb} = 25 °C)

Symbol	Parameter							
V _{BR}	Breakdown voltage							
I _{RM}	Leakage current @ V _{RM}							
V _{RM}	Stand-off voltage							
V _{CL}	Clamping voltage							
R _d	Dynamic impedance							
I _{PP}	Peak pulse current							
αT	Voltage temperature coefficient							
C	Capacitance							
Order code	V _{BR} @ I _R							
	min.	max		max.		typ. ⁽¹⁾	max. ⁽²⁾	max. 0 V bias
	V	V	mA	µA	V	Ω	10 ⁻⁴ /C	pF
ESDA14V2-2BF3	14.2	18	1	0.5 0.1	12 3	3.2	6.5	12

1. Square pulse, I_{pp} = 3 A, t_p = 2.5 µs.
2. $\Delta V_{BR} = \alpha T * (T_{amb} - 25\text{ °C}) * V_{BR} (25\text{ °C})$

Figure 3. Relative variation of peak pulse power versus initial junction temperature

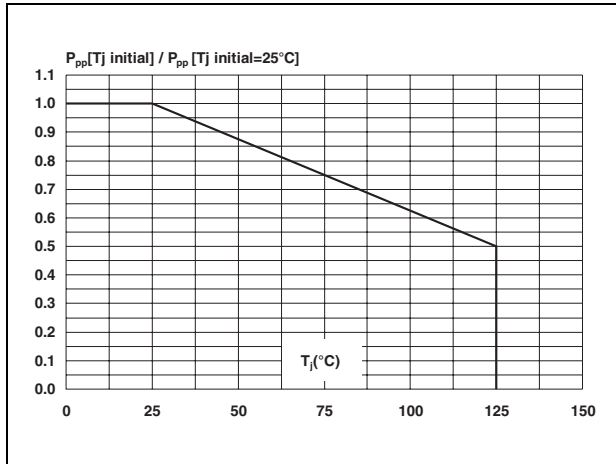

Figure 4. Peak pulse power versus exponential pulse duration

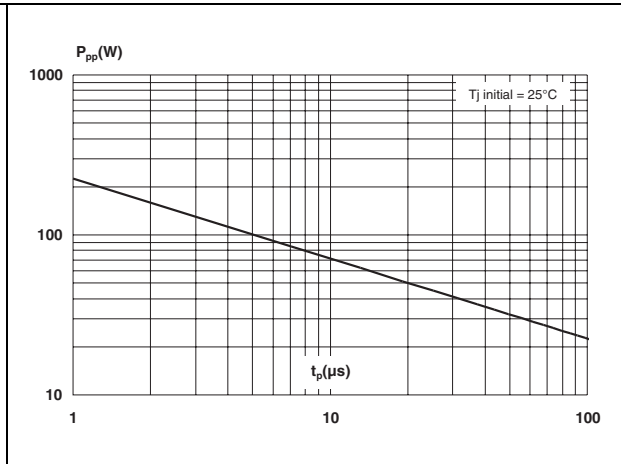

Figure 5. Clamping voltage versus peak pulse current (typical values, rectangular waveform)

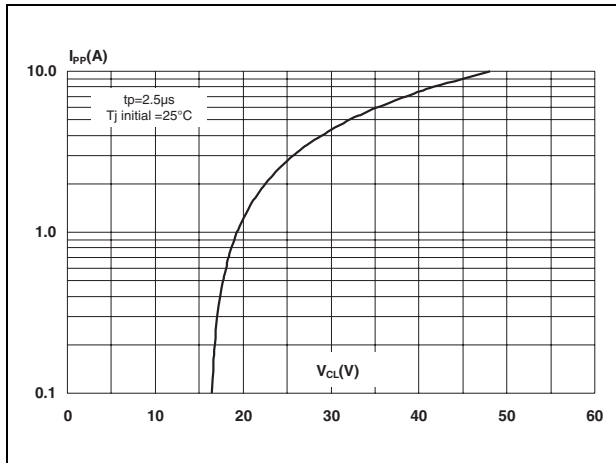

Figure 6. Junction capacitance versus reverse applied voltage (typical values)

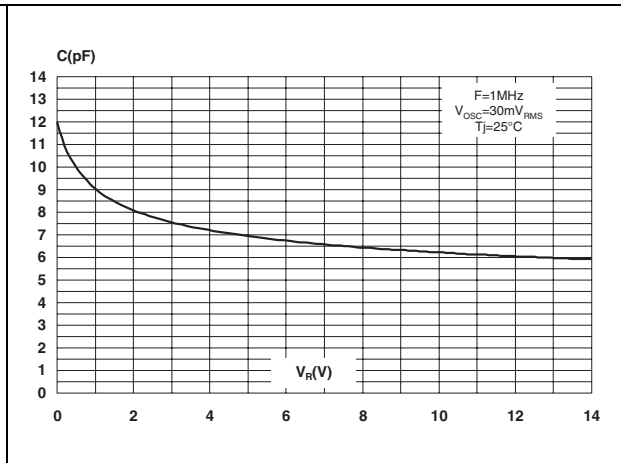

Figure 7. Relative variation of leakage current versus junction temperature (typical values)

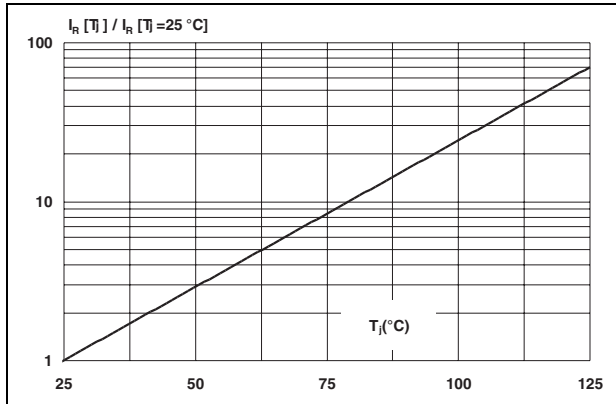

Figure 8. Analog crosstalk measurement

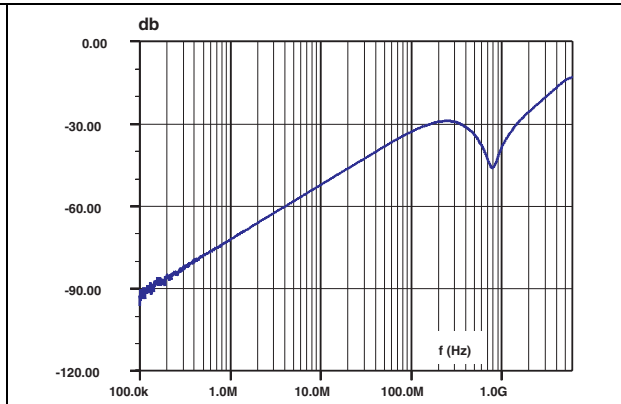

Figure 9. ESD response to IEC 61000-4-2 (+15 kV air discharge)

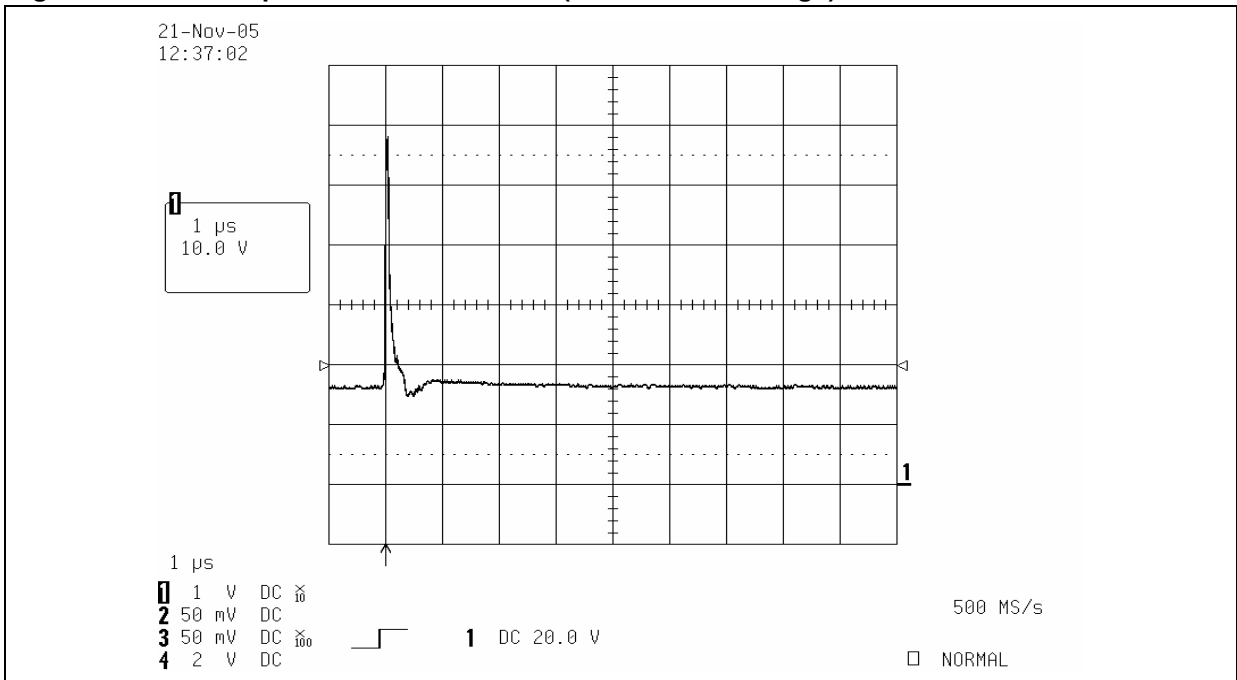

Figure 10. ESD response to IEC 61000-4-2 (-15 kV air discharge)

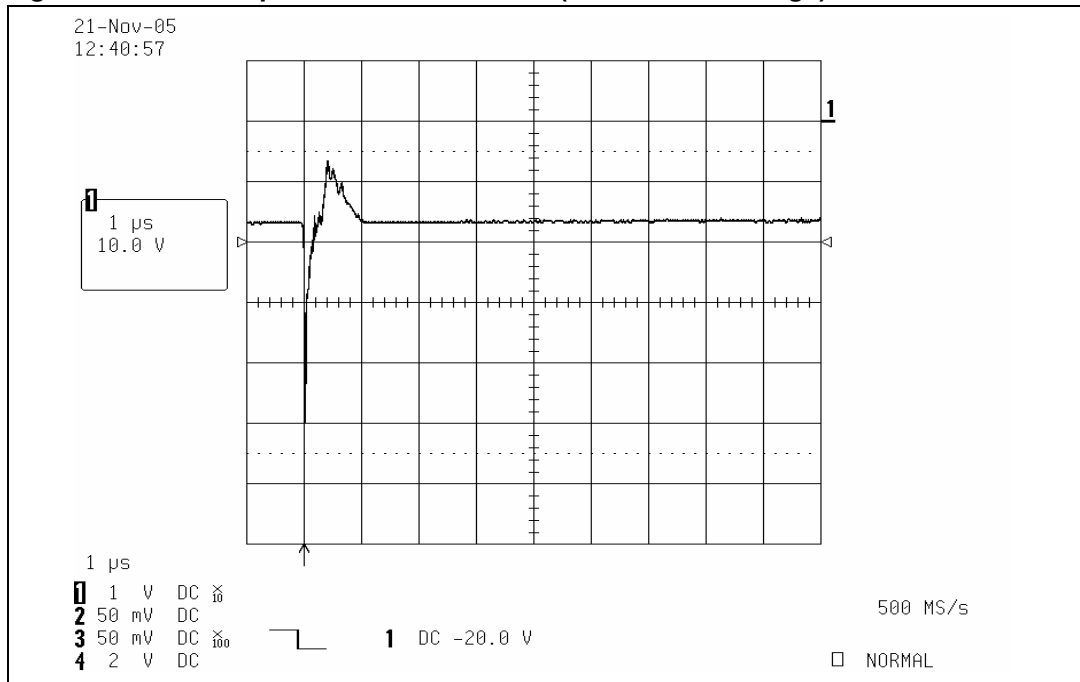
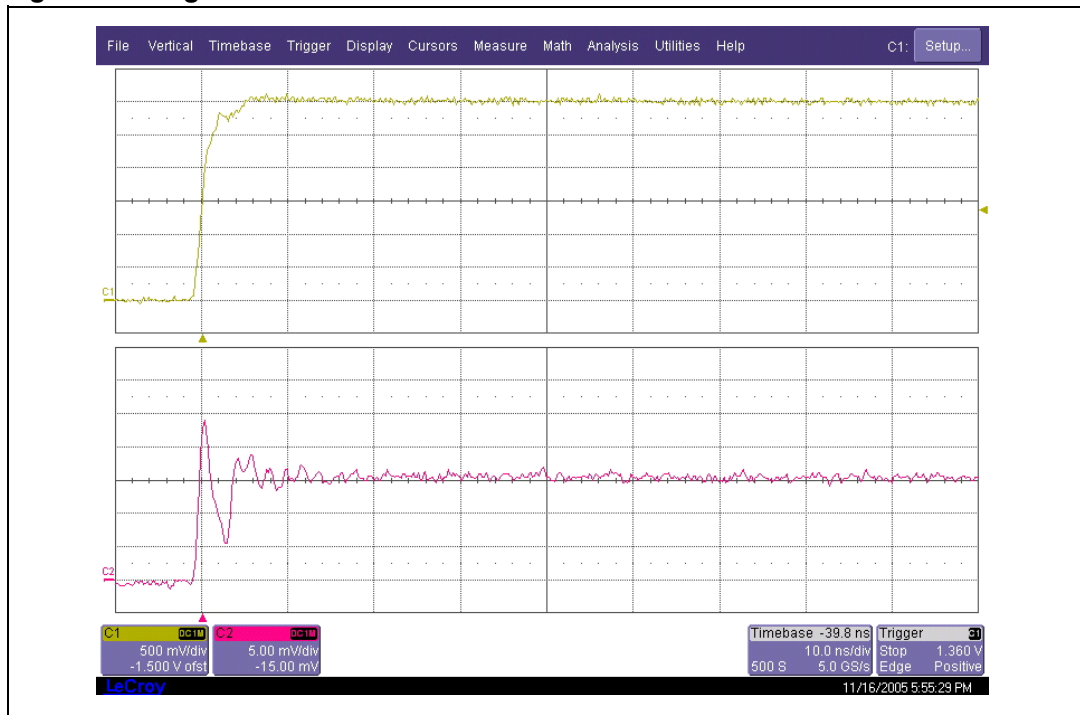
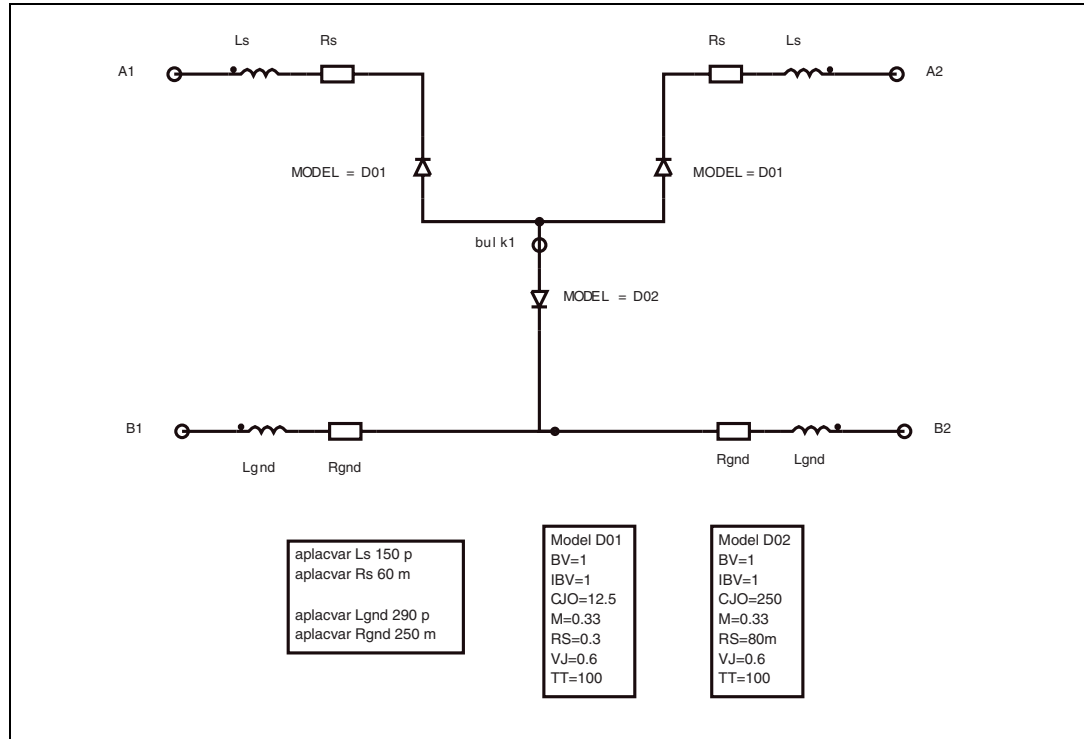

Figure 11. Digital crosstalk measurement



2 Application information

Figure 12. Aplac model



3 Ordering information scheme

Figure 13. Ordering information scheme

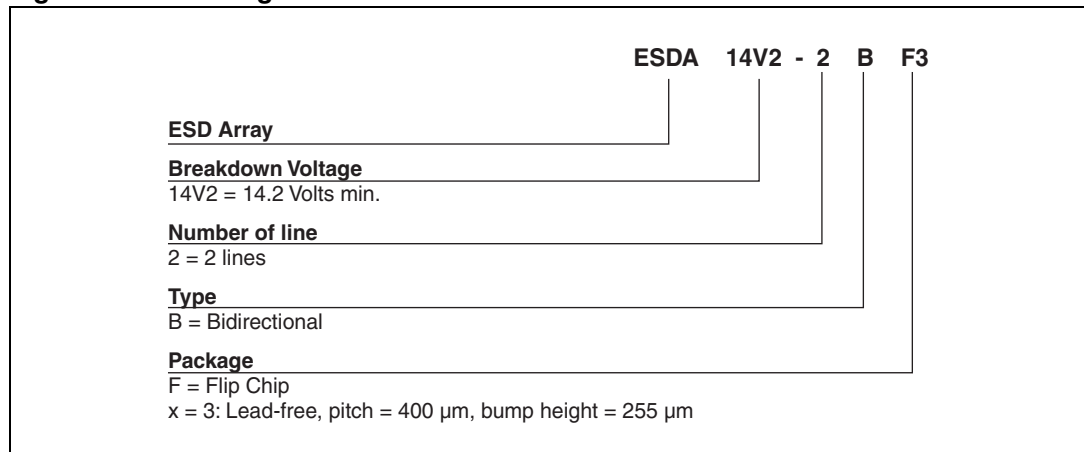

4 Package information

In order to meet environmental requirements, ST offers these devices in ECOPACK® packages. These packages have a lead-free second level interconnect. The category of second level interconnect is marked on the inner box label, in compliance with JEDEC Standard JESD97. The maximum ratings related to soldering conditions are also marked on the inner box label. ECOPACK is an ST trademark. ECOPACK specifications are available at www.st.com.

Figure 14. Package dimensions

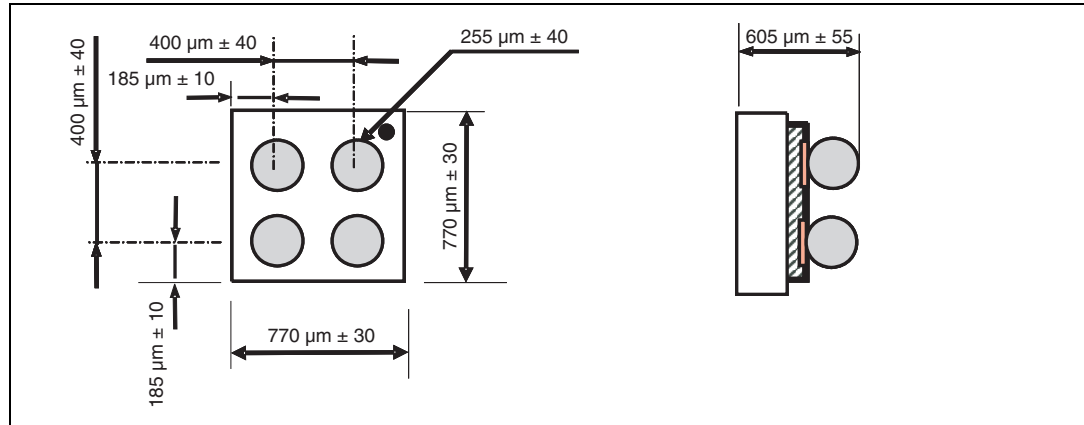

Figure 15. Footprint

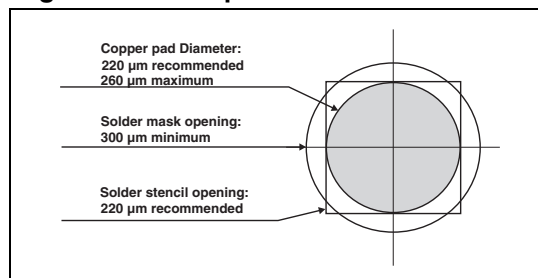

Figure 16. Marking

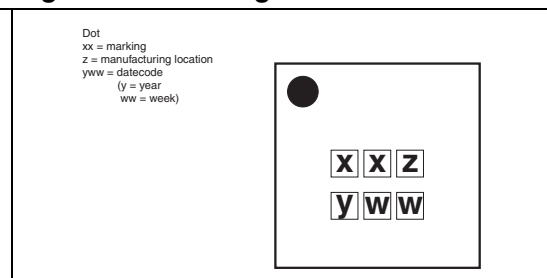
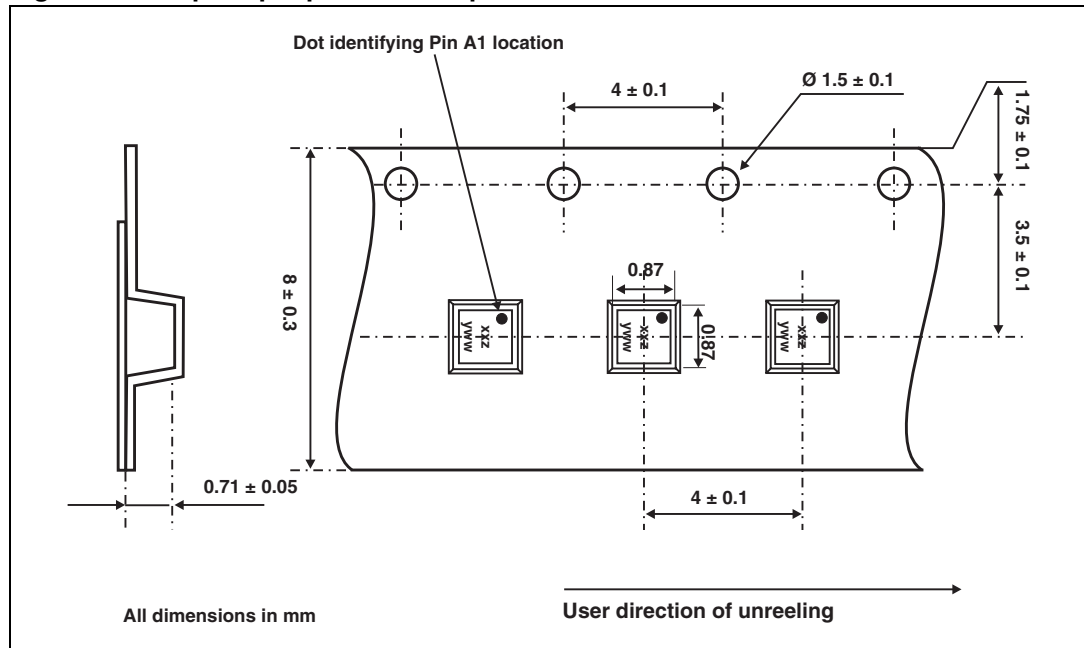

Figure 17. Flip Chip tape and reel specifications



Note: More information is available in the application note:
 AN2348 : "400 µm Flip Chip: Package description and recommendations for use"
 AN1751 : EMI Filters: Recommendations and measurements

5 Ordering information

Table 3. Ordering information

Order code	Marking	Package	Weight	Base qty	Delivery mode
ESDA14V2-2BF3	EG	Flip Chip	0.79 mg	5000	Tape and reel 7"

6 Revision history

Table 4. Document revision history

Date	Revision	Changes
02-Dec-2005	1	Initial release.
15-Dec-2005	2	Ordering information changed.
29-Apr-2008	3	Updated ECOPACK statement. Updated Figure 13 and Figure 17 . Reformatted to current standards.

Please Read Carefully:

Information in this document is provided solely in connection with ST products. STMicroelectronics NV and its subsidiaries ("ST") reserve the right to make changes, corrections, modifications or improvements, to this document, and the products and services described herein at any time, without notice.

All ST products are sold pursuant to ST's terms and conditions of sale.

Purchasers are solely responsible for the choice, selection and use of the ST products and services described herein, and ST assumes no liability whatsoever relating to the choice, selection or use of the ST products and services described herein.

No license, express or implied, by estoppel or otherwise, to any intellectual property rights is granted under this document. If any part of this document refers to any third party products or services it shall not be deemed a license grant by ST for the use of such third party products or services, or any intellectual property contained therein or considered as a warranty covering the use in any manner whatsoever of such third party products or services or any intellectual property contained therein.

UNLESS OTHERWISE SET FORTH IN ST'S TERMS AND CONDITIONS OF SALE ST DISCLAIMS ANY EXPRESS OR IMPLIED WARRANTY WITH RESPECT TO THE USE AND/OR SALE OF ST PRODUCTS INCLUDING WITHOUT LIMITATION IMPLIED WARRANTIES OF MERCHANTABILITY, FITNESS FOR A PARTICULAR PURPOSE (AND THEIR EQUIVALENTS UNDER THE LAWS OF ANY JURISDICTION), OR INFRINGEMENT OF ANY PATENT, COPYRIGHT OR OTHER INTELLECTUAL PROPERTY RIGHT.

UNLESS EXPRESSLY APPROVED IN WRITING BY AN AUTHORIZED ST REPRESENTATIVE, ST PRODUCTS ARE NOT RECOMMENDED, AUTHORIZED OR WARRANTED FOR USE IN MILITARY, AIR CRAFT, SPACE, LIFE SAVING, OR LIFE SUSTAINING APPLICATIONS, NOR IN PRODUCTS OR SYSTEMS WHERE FAILURE OR MALFUNCTION MAY RESULT IN PERSONAL INJURY, DEATH, OR SEVERE PROPERTY OR ENVIRONMENTAL DAMAGE. ST PRODUCTS WHICH ARE NOT SPECIFIED AS "AUTOMOTIVE GRADE" MAY ONLY BE USED IN AUTOMOTIVE APPLICATIONS AT USER'S OWN RISK.

Resale of ST products with provisions different from the statements and/or technical features set forth in this document shall immediately void any warranty granted by ST for the ST product or service described herein and shall not create or extend in any manner whatsoever, any liability of ST.

ST and the ST logo are trademarks or registered trademarks of ST in various countries.

Information in this document supersedes and replaces all information previously supplied.

The ST logo is a registered trademark of STMicroelectronics. All other names are the property of their respective owners.

© 2008 STMicroelectronics - All rights reserved

STMicroelectronics group of companies

Australia - Belgium - Brazil - Canada - China - Czech Republic - Finland - France - Germany - Hong Kong - India - Israel - Italy - Japan - Malaysia - Malta - Morocco - Singapore - Spain - Sweden - Switzerland - United Kingdom - United States of America

www.st.com

X-ON Electronics

Largest Supplier of Electrical and Electronic Components

Click to view similar products for [ESD Suppressors / TVS Diodes](#) category:

Click to view products by [STMicroelectronics](#) manufacturer:

Other Similar products are found below :

[60KS200C](#) [D12V0H1U2WS-7](#) [D18V0L1B2LP-7B](#) [82356050220](#) [D5V0M5U6V-7](#) [NTE4902](#) [P4KE27CA](#) [P6KE11CA](#) [P6KE39CA-TP](#)
[P6KE8.2A](#) [SA110CA](#) [SA60CA](#) [SA64CA](#) [SMBJ12CATR](#) [SMBJ8.0A](#) [SMLJ30CA-TP](#) [ESD101-B1-02ELS E6327](#) [ESD112-B1-02EL E6327](#)
[ESD119B1W01005E6327XTSA1](#) [ESD5V0J4-TP](#) [ESD5V0L1B02VH6327XTSA1](#) [ESD7451N2T5G](#) [19180-510](#) [CPDT-5V0USP-HF](#)
[3.0SMCJ33CA-F](#) [3.0SMCJ36A-F](#) [HSPC16701B02TP](#) [D3V3Q1B2DLP3-7](#) [D55V0M1B2WS-7](#) [DESD5V0U1BL-7B](#) [DRTR5V0U4SL-7](#)
[SCM1293A-04SO](#) [ESD200-B1-CSP0201 E6327](#) [ESD203-B1-02EL E6327](#) [SM12-7](#) [SMF8.0A-TP](#) [SMLJ45CA-TP](#) [CEN955 W/DATA](#)
[82350120560](#) [82356240030](#) [VESD12A1A-HD1-GS08](#) [CPDUR5V0R-HF](#) [CPDUR24V-HF](#) [CPDQC5V0U-HF](#) [CPDQC5V0USP-HF](#)
[CPDQC5V0-HF](#) [D1213A-01LP4-7B](#) [D1213A-02WL-7](#) [ESDLIN1524BJ-HQ](#) [5KP100A](#)