

## High power transient voltage suppressor

Datasheet - production data

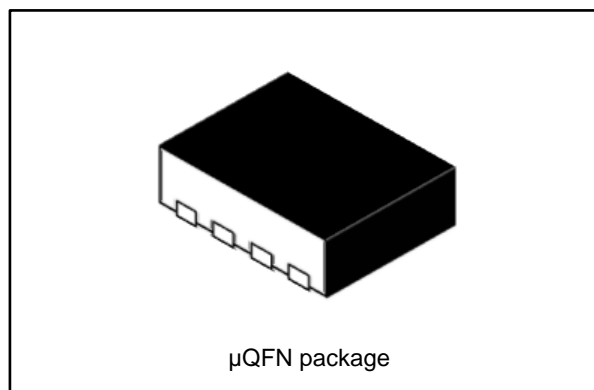

### Features

- Low clamping voltage
- Peak pulse power: 4800 W (8/20 μs)
- Stand-off voltage 15 V
- Unidirectional diode
- Low leakage current: 0.2 μA at 25 °C
- Complies with IEC 61000-4-2 level 4
  - ±30 kV (air discharge)
  - ±30 kV (contact discharge)

### Applications

Where transient overvoltage protection in ESD sensitive equipment is required, such as:

- Smartphones, mobile phones, tablets, portable multimedia
- USB  $V_{BUS}$  protection
- Power supply protection
- Battery protection

### Description

The ESDA17P100-1U2M is a unidirectional single line TVS diode designed to protect the power line against EOS and ESD transients.

The device is ideal for applications where high power TVS and board space saving is required.

**Figure 1: Pin configuration**

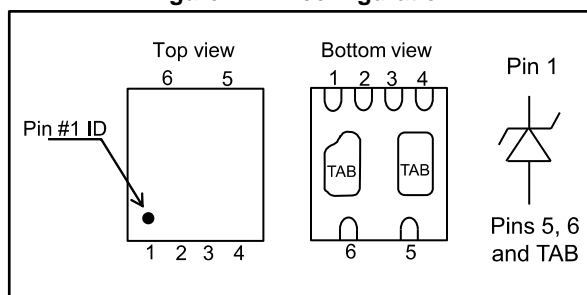

**Table 1: Device summary**

Pin	Name	Description
1	$V_{BUS}$	$V_{BUS}$ pin
2, 3, 4	NC	Non connected pin
5, 6	GND	Ground pin
TAB	GND	Ground pin

# 1 Characteristics

**Table 2: Absolute maximum ratings (T<sub>amb</sub> = 25 °C)**

Symbol	Parameter		Value	Unit
V <sub>PP</sub>	Peak pulse voltage	IEC 61000-4-2: Contact discharge Air discharge	>30 >30	kV
P <sub>PP</sub>	Peak pulse power	8/20µs	4800	W
I <sub>PP</sub>	Peak pulse current	8/20µs	160	A
T <sub>stg</sub>	Storage junction temperature range		-55 to + 150	°C
T <sub>op</sub>	Operating junction temperature range		-55 to + 150	

**Figure 2: Electrical characteristics (definitions)**

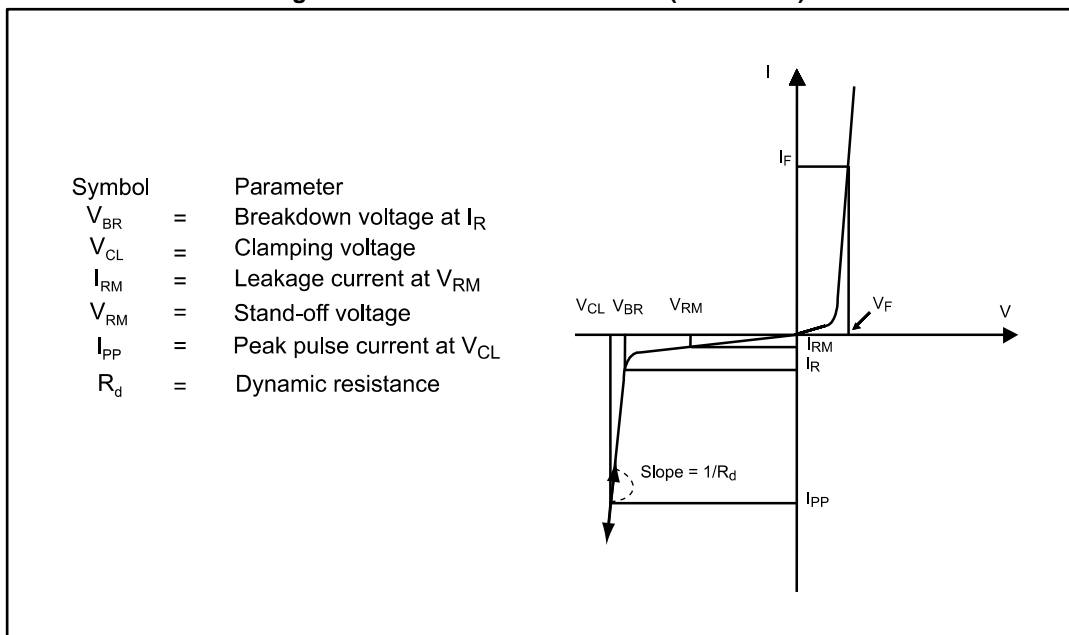

**Table 3: Electrical characteristics (T<sub>amb</sub> = 25 °C)**

Symbol	Test condition	Min.	Typ.	Max.	Unit
V <sub>BR</sub>	I <sub>R</sub> = 1 mA	15.7	16.5	17.7	V
V <sub>RM</sub>				15	V
I <sub>RM</sub>	V <sub>RM</sub> = 12 V			100	nA
I <sub>RM</sub>	V <sub>RM</sub> = 15 V			200	nA
R <sub>d</sub>	8/20 µs		0.07		Ω
V <sub>CL</sub>	I <sub>PP</sub> = 100 A, 8/20 µs		24	26	V
V <sub>CL</sub>	I <sub>PP</sub> = 160 A, 8/20 µs		28	30	V
C <sub>BUS</sub>	V <sub>BUS</sub> = 0 V, f = 1 MHz, V <sub>OSC</sub> = 30 mV		1200		pF

# 1.1 Curves

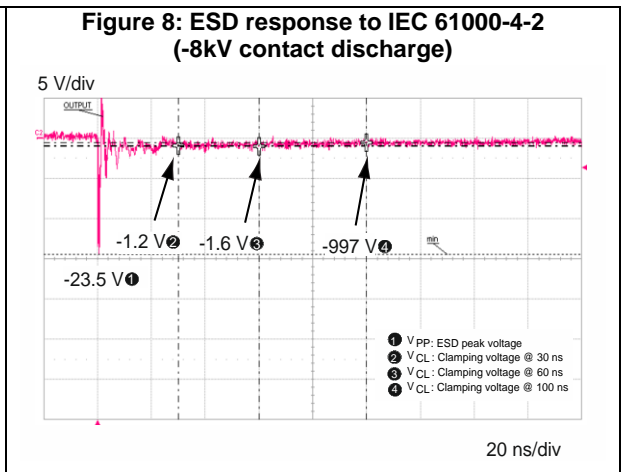
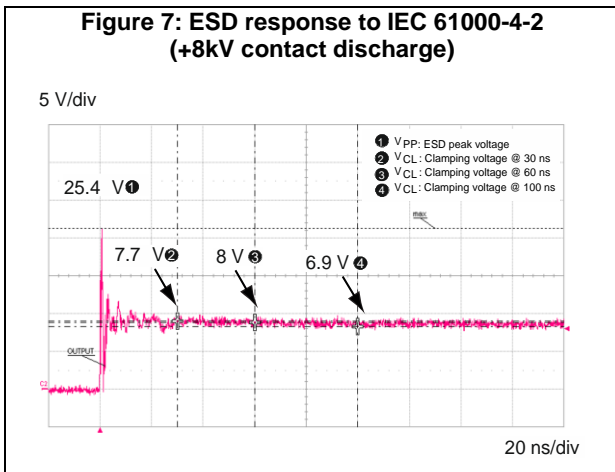
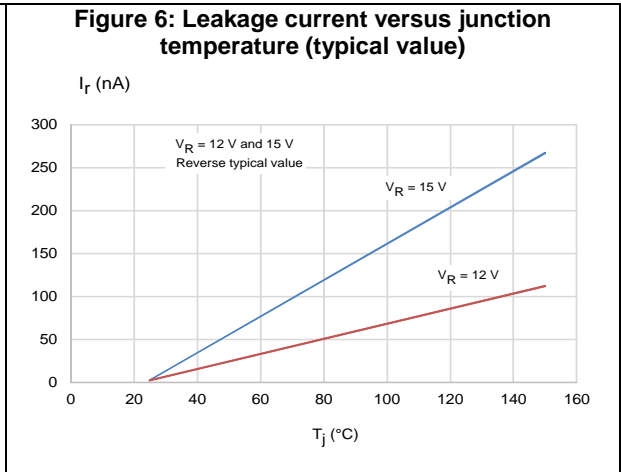
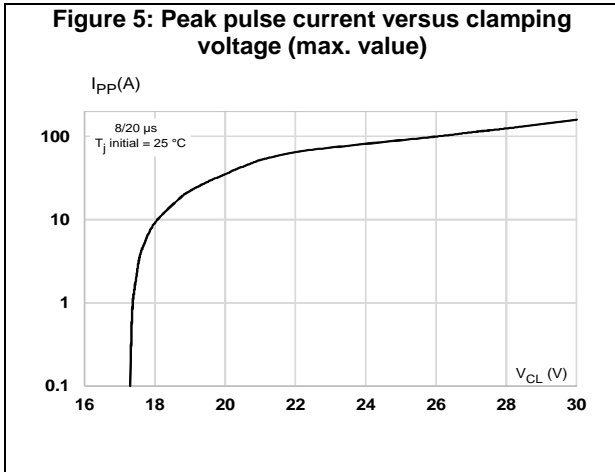
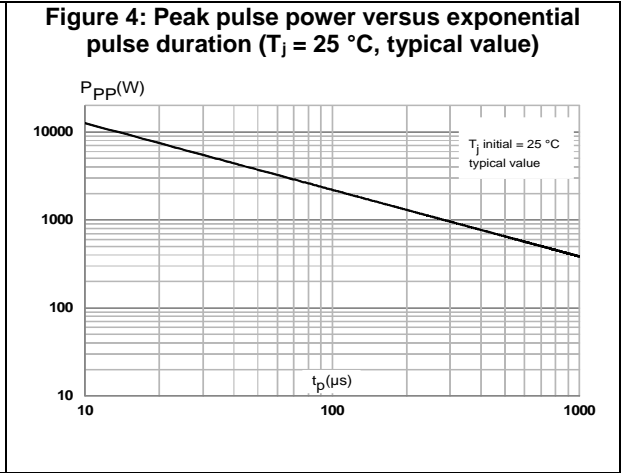
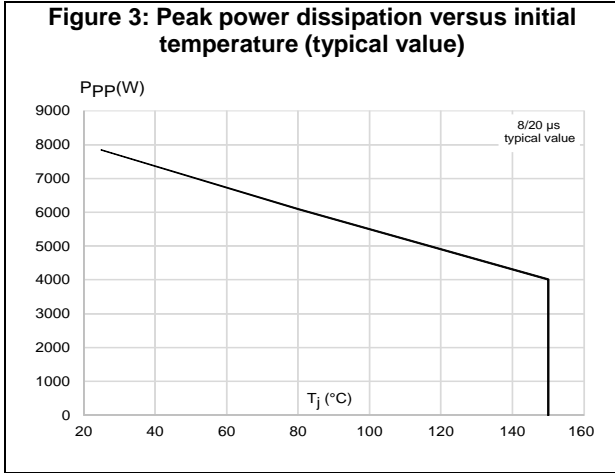

## 2 Package information

In order to meet environmental requirements, ST offers these devices in different grades of ECOPACK® packages, depending on their level of environmental compliance. ECOPACK® specifications, grade definitions and product status are available at: [www.st.com](http://www.st.com). ECOPACK® is an ST trademark.

### 2.1 QFN1610

Figure 9:  $\mu$ QFN package outline

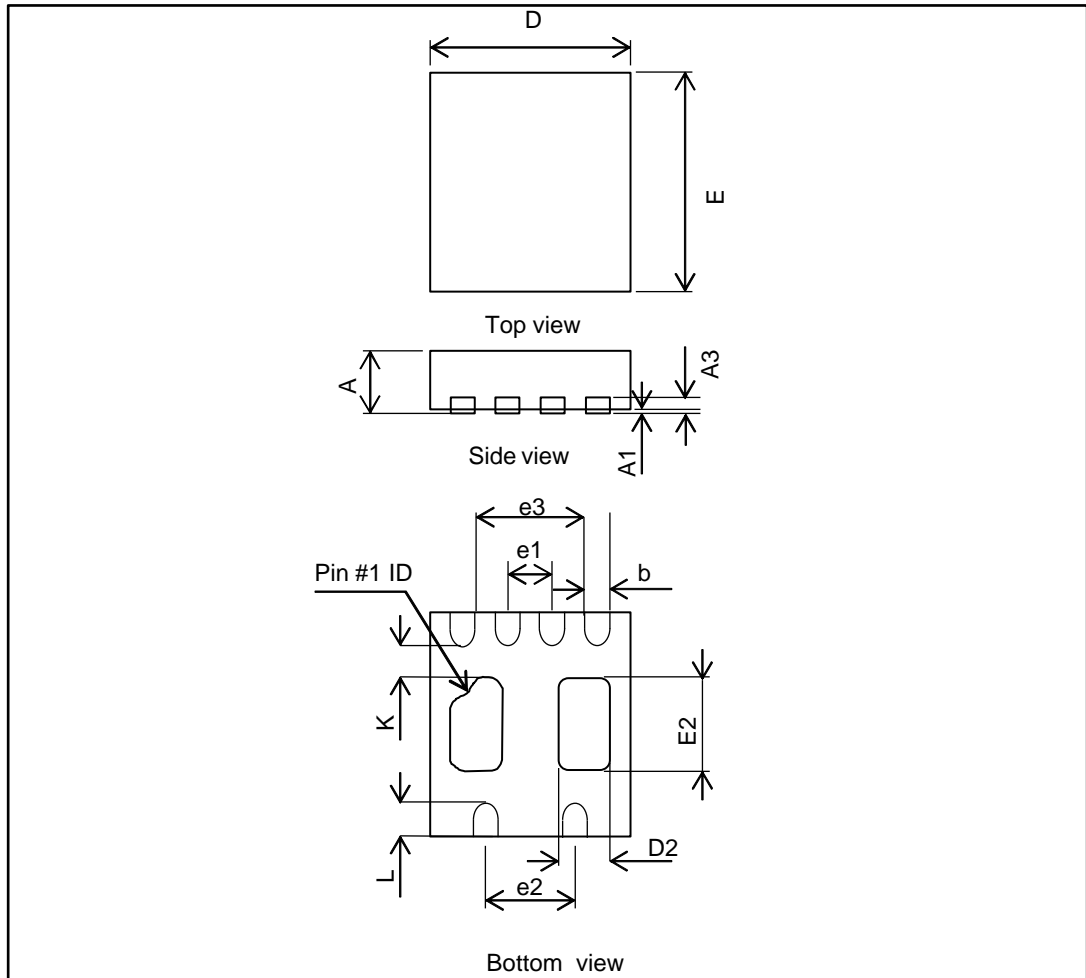
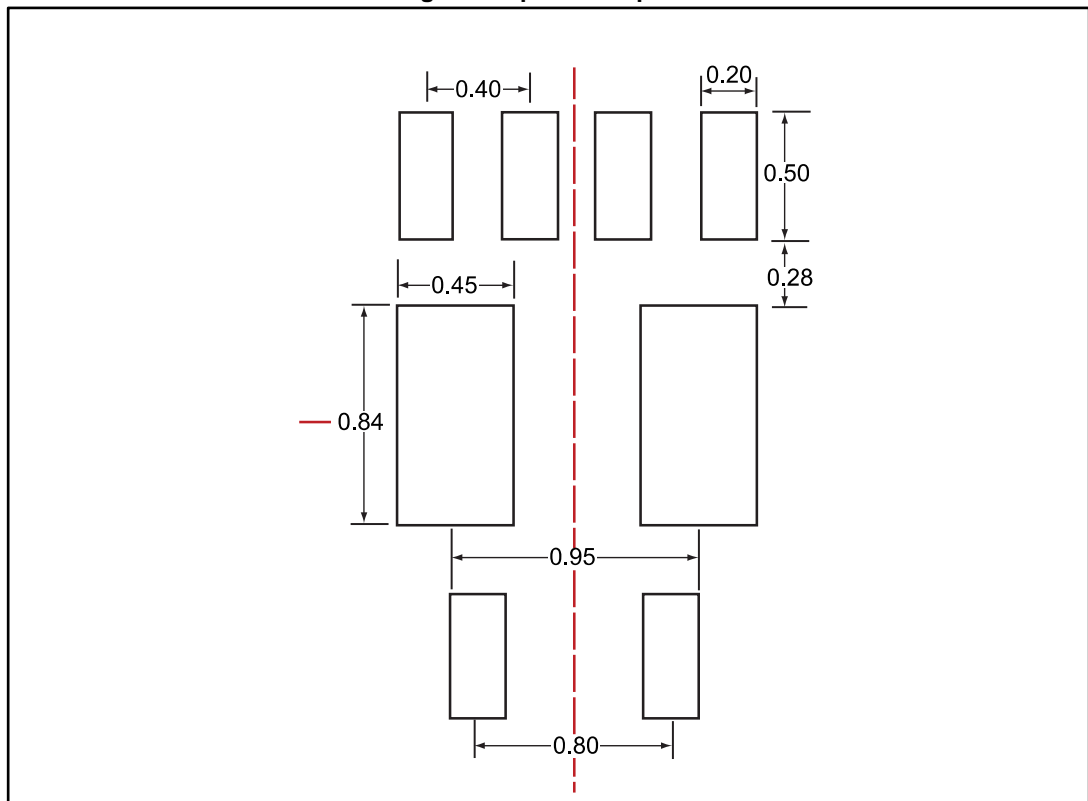
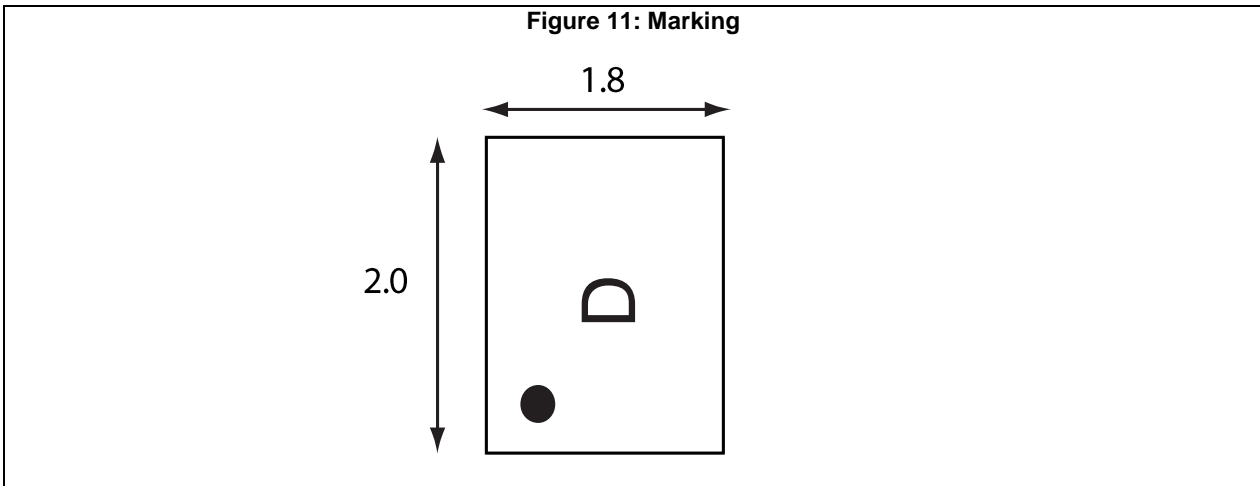

Table 4:  $\mu$ QFN package mechanical data

Ref.	Dimensions					
	Millimeters			Inches		
	Min.	Typ.	Max.	Min.	Typ.	Max.
A	0.51	0.55	0.60	0.0201	0.0217	0.0236
A1	0.00	0.02	0.05	0.0000	0.0008	0.0020
A3		0.15				
b	0.15	0.20	0.25	0.0059	0.0079	0.0098
D	1.70	1.80	1.90	0.0669	0.0709	0.0748
E	1.90	2.0	2.10	0.0748	0.0787	0.0827
e1		0.4			0.0157	
e2		0.80			0.0315	
D2	0.30	0.45	0.55	0.0118	0.0177	0.0217
E2	0.69	0.84	0.94	0.0272	0.0331	0.0370
e3		0.95			0.0374	
k		0.28			0.0110	
L	0.20	0.030	0.40	0.0079	0.0118	0.0157
N		6.00				

Figure 10:  $\mu$ QFN footprint





Product marking may be rotated by multiples of 90° for assembly plant differentiation. In no case should this product marking be used to orient the component for its placement on a PCB. Only pin 1 mark is to be used for this purpose.

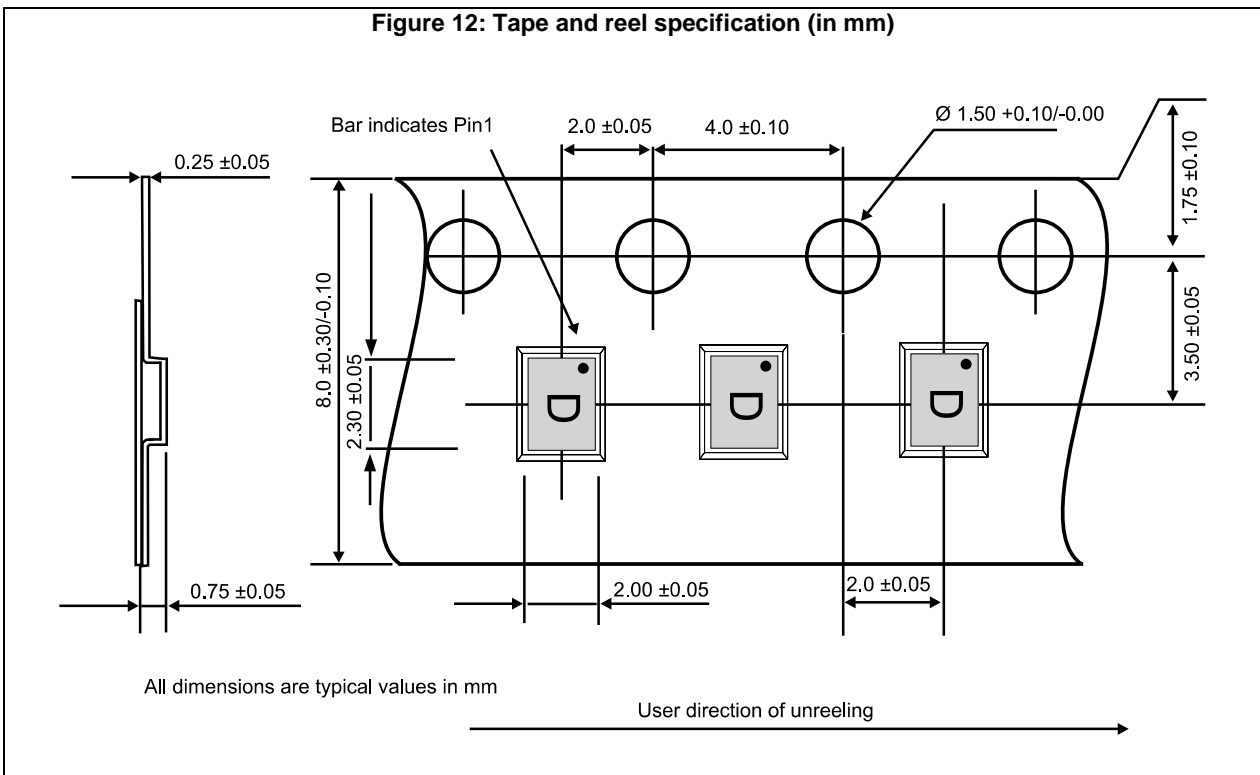

### 3 Recommendation PCB

#### 3.1 Stencil opening

1. General recommendation on stencil opening design
  - a. Stencil opening dimensions: L (Length), W (Width), T (Thickness).
2. General design rule
  - a. Stencil thickness (T) = 75 ~ 125  $\mu\text{m}$
  - b. Aspect ratio =  $\frac{W}{T} \geq 1.5$
  - c. Aspect area =  $\frac{L \times W}{2T(L+W)} \geq 0.66$
3. Reference design
  - a. Stencil opening thickness: 100  $\mu\text{m}$
  - b. Stencil opening for leads: Opening to footprint ratio is 90%.

Figure 13: Stencil opening dimensions

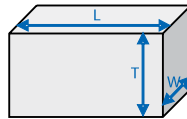
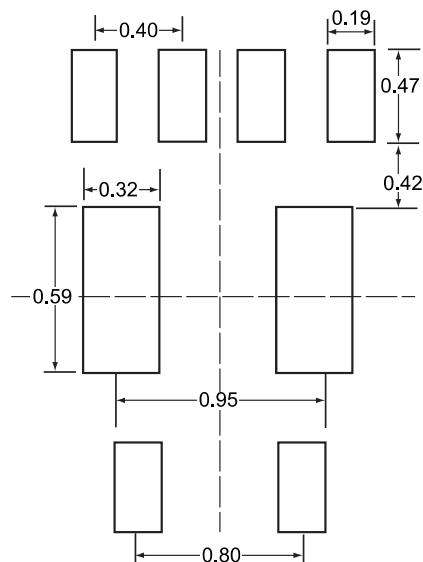

Figure 14: Recommended stencil window position



### 3.2 Solder paste

1. Use halide-free flux, qualification ROL0 according to ANSI/J-STD-004.
2. "No clean" solder paste is recommended.
3. Offers a high tack force to resist component movement during PCB movement.
4. Solder paste with fine particles: powder particle size is 20-45 µm.

### 3.3 Placement

1. Manual positioning is not recommended.
2. It is recommended to use the lead recognition capabilities of the placement system, not the outline centering
3. Standard tolerance of ±0.05 mm is recommended.
4. 3.5 N placement force is recommended. Too much placement force can lead to squeezed out solder paste and cause solder joints to short. Too low placement force can lead to insufficient contact between package and solder paste that could cause open solder joints or badly centered packages.
5. To improve the package placement accuracy, a bottom side optical control should be performed with a high resolution tool.
6. For assembly, a perfect supporting of the PCB (all the more on flexible PCB) is recommended during solder paste printing, pick and place and reflow soldering by using optimized tools.

### 3.4 PCB design preference

1. To control the solder paste amount, the closed via is recommended instead of open vias.
2. The position of tracks and open vias in the solder area should be well balanced. A symmetrical layout is recommended, to avoid any tilt phenomena caused by asymmetrical solder paste due to solder flow away.

### 3.5 Reflow

Figure 15: ST ECOPACK® recommended soldering reflow profile for PCB mounting

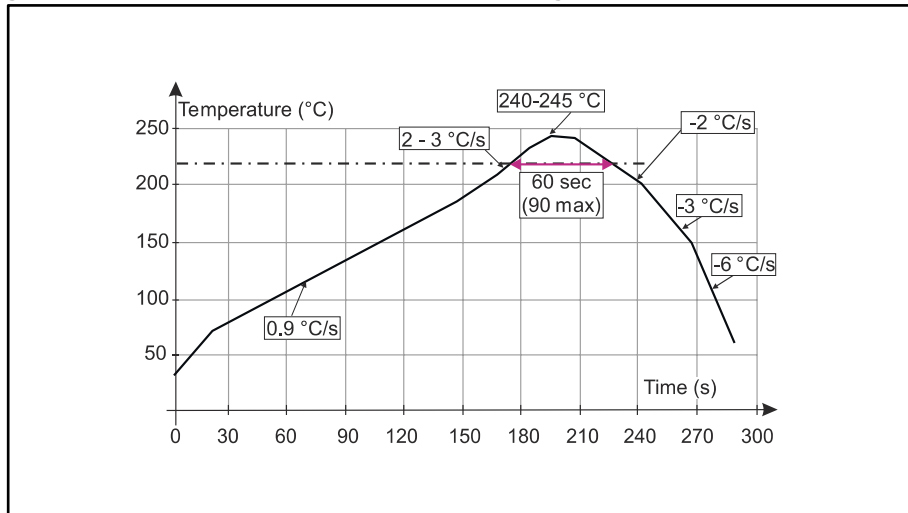

Minimize air convection currents in the reflow oven to avoid component movement.



## 4 Ordering information

Figure 16: Ordering information scheme

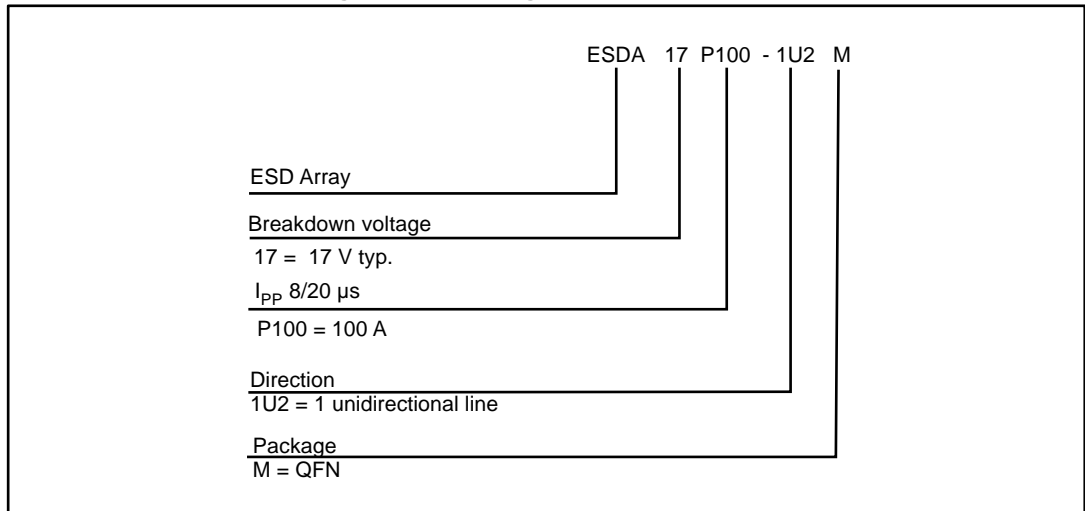

Table 5: Ordering information

Order code	Marking <sup>(1)</sup>	Package	Weight	Base qty.	Delivery mode
ESDA17P100-1U2M	D	$\mu$ QFN	6 mg	5000	Tape and reel

**Notes:**

<sup>(1)</sup>The marking can be rotated by multiples of 90° to differentiate assembly location

## 5 Revision history

Table 6: Document revision history

Date	Revision	Changes
14-Mar-2017	1	Initial release.

**IMPORTANT NOTICE – PLEASE READ CAREFULLY**

STMicroelectronics NV and its subsidiaries ("ST") reserve the right to make changes, corrections, enhancements, modifications, and improvements to ST products and/or to this document at any time without notice. Purchasers should obtain the latest relevant information on ST products before placing orders. ST products are sold pursuant to ST's terms and conditions of sale in place at the time of order acknowledgement.

Purchasers are solely responsible for the choice, selection, and use of ST products and ST assumes no liability for application assistance or the design of Purchasers' products.

No license, express or implied, to any intellectual property right is granted by ST herein.

Resale of ST products with provisions different from the information set forth herein shall void any warranty granted by ST for such product.

ST and the ST logo are trademarks of ST. All other product or service names are the property of their respective owners.

Information in this document supersedes and replaces information previously supplied in any prior versions of this document.

© 2017 STMicroelectronics – All rights reserved

## X-ON Electronics

Largest Supplier of Electrical and Electronic Components

*Click to view similar products for [ESD Suppressors / TVS Diodes](#) category:*

*Click to view products by [STMicroelectronics](#) manufacturer:*

Other Similar products are found below :

[60KS200C](#) [D12V0H1U2WS-7](#) [D18V0L1B2LP-7B](#) [82356050220](#) [D5V0M5U6V-7](#) [NTE4902](#) [P4KE27CA](#) [P6KE11CA](#) [P6KE39CA-TP](#)  
[P6KE8.2A](#) [SA110CA](#) [SA60CA](#) [SA64CA](#) [SMBJ12CATR](#) [SMBJ8.0A](#) [SMLJ30CA-TP](#) [ESD101-B1-02ELS E6327](#) [ESD112-B1-02EL E6327](#)  
[ESD119B1W01005E6327XTSA1](#) [ESD5V0J4-TP](#) [ESD5V0L1B02VH6327XTSA1](#) [ESD7451N2T5G](#) [19180-510](#) [CPDT-5V0USP-HF](#)  
[3.0SMCJ33CA-F](#) [3.0SMCJ36A-F](#) [HSPC16701B02TP](#) [D3V3Q1B2DLP3-7](#) [D55V0M1B2WS-7](#) [DESD5V0U1BL-7B](#) [DRTR5V0U4SL-7](#)  
[SCM1293A-04SO](#) [ESD200-B1-CSP0201 E6327](#) [ESD203-B1-02EL E6327](#) [SM12-7](#) [SMF8.0A-TP](#) [SMLJ45CA-TP](#) [CEN955 W/DATA](#)  
[82350120560](#) [82356240030](#) [VESD12A1A-HD1-GS08](#) [CPDUR5V0R-HF](#) [CPDUR24V-HF](#) [CPDQC5V0U-HF](#) [CPDQC5V0USP-HF](#)  
[CPDQC5V0-HF](#) [D1213A-01LP4-7B](#) [D1213A-02WL-7](#) [ESDLIN1524BJ-HQ](#) [5KP100A](#)