

## Quad Transil™ array for ESD protection

Datasheet - production data

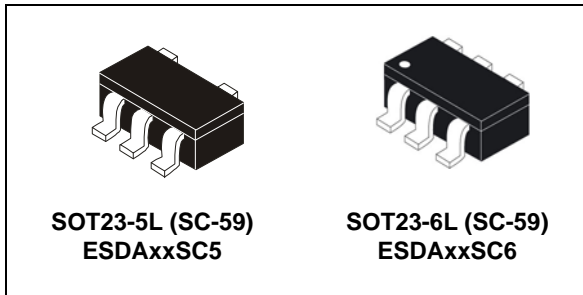

### Description

The ESDAxxSC5 and ESDAxxSC6 are monolithic voltage suppressors designed to protect components which are connected to data and transmission lines against ESD.

They clamp the voltage just above the logic level supply for positive transients, and to a diode drop below ground for negative transient.

### Features

- 4 unidirectional ESD protection
- 400 W peak pulse power (8/20  $\mu$ s)
- Benefits
  - High ESD protection level: up to 30 kV
  - High integration
  - Suitable for high density boards
- Complies with the following standards
  - IEC 61000-4-2 level exceed level 4:
  - 30 kV (air discharge)
  - 30 kV (contact discharge)
- MIL STD 883E- Method 3015-7: class3B
  - human body model

Figure 1. ESDAxxSC5 functional diagram

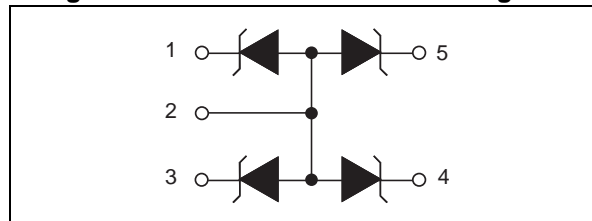
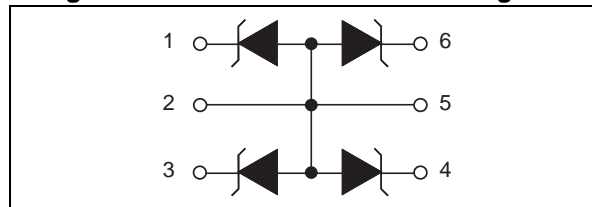

Figure 2. ESDAxxSC6 functional diagram



### Applications

Where transient overvoltage protection in ESD sensitive equipment is required, such as:

- Computers
- Printers
- Communication systems
- Cellular phone handsets and accessories
- Other telephone set
- Set top boxes

Table 1. Device summary

Order code	$V_{BR}$ min.	Package
ESDA5V3SC5	5.3 V	SOT23-5L
ESDA5V3SC6	5.3 V	SOT23-6L
ESDA6V1SC5	6.1 V	SOT23-5L
ESDA6V1SC6	6.1 V	SOT23-6L
ESDA14V2SC5	14.2 V	SOT23-5L
ESDA14V2SC6	14.2 V	SOT23-6L
ESDA19SC6	19 V	SOT23-6L
ESDA25SC6	25 V	SOT23-6L

TM: Transil is a trademark of STMicroelectronics.

# 1 Characteristics

**Table 2. Absolute ratings ( $T_{amb} = 25\text{ }^{\circ}\text{C}$ )**

Symbol	Parameter		Value	Unit
$V_{PP}$	ESD discharge	MIL STD 883E - Method 3015-7 IEC61000-4-2 air discharge IEC61000-4-2 contact discharge	30	kV
$P_{PP}$	Peak pulse power (8/20 $\mu$ s)	ESDA5V3SCx ESDA6V1SCx	300	W
		ESDA14V2SCx ESDA19SC6 ESDA25SC6	400	W
$I_{PP}$	Peak pulse current	ESDA5V3SCx	22	A
		ESDA6V1SCx	18	
		ESDA14V2SCx	14	
		ESDA19SC6	13	
		ESDA25SC6	9	
$T_{stg}$	Storage temperature range		-55 to +150	$^{\circ}\text{C}$
$T_L$	Maximum lead temperature for soldering during 10 s		260	$^{\circ}\text{C}$
$T_{op}$	Operating junction temperature range		-55 to +150	$^{\circ}\text{C}$

**Table 3. Electrical characteristics - definitions ( $T_{amb} = 25\text{ }^{\circ}\text{C}$ )**

Symbol	Parameter
$V_{RM}$	Stand-off voltage
$V_{BR}$	Breakdown voltage
$V_{CL}$	Clamping voltage
$I_{RM}$	Leakage current @ $V_{RM}$
$I_{PP}$	Peak pulse current
$\alpha T$	Voltage temperature coefficient
C	Capacitance
$R_d$	Dynamic resistance
$V_F$	Forward voltage drop

Table 4. Electrical characteristics - values ( $T_{amb} = 25\text{ }^{\circ}\text{C}$ )

Order codes	$V_{BR} @ I_R$			$I_{RM} @ V_{RM}$		$V_{CL} @ I_{PP}$		$\alpha T$	C	$V_F @ I_F$	
	min.	max.		max.		max.		max. <sup>(1)</sup>	typ. 0 V bias	max.	
	V	V	mA	$\mu\text{A}$	V	V	A	$10^{-4}/^{\circ}\text{C}$	pF	V	mA
ESDA5V3SC5 ESDA5V3SC6	5.3	5.9	1	2	3	21	22	5	320	1.25	200
ESDA6V1SC5 ESDA6V1SC6	6.1	7.2	1	2	5.25	19	18	6	190	1.25	200
ESDA14V2SC5 ESDA14V2SC6	14.2	15.8	1	5	12	35	14	10	100	1.25	200
ESDA19SC6	19	21	1	0.1	15	39	13	8.5	80	1.2	10
ESDA25SC6	25	30	1	1	24	51	9	10	60	1.2	10

1.  $V_{BR} @ T_J = V_{BR} @ 25\text{ }^{\circ}\text{C} \times (1 + \alpha T \times (T_J - 25))$

Figure 3. Peak power dissipation versus initial junction temperature

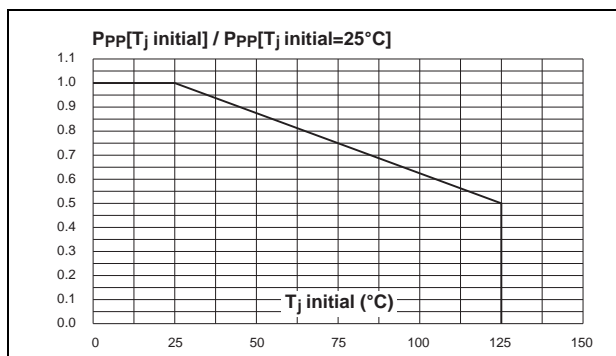

Figure 4. Peak pulse power versus exponential pulse duration ( $T_j \text{ initial} = 25\text{ }^{\circ}\text{C}$ )

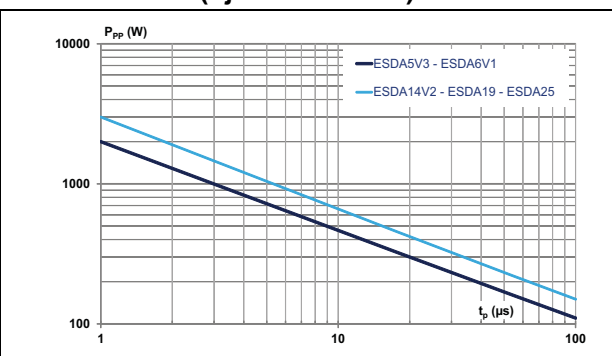

Figure 5. Clamping voltage versus peak pulse current ( $T_j \text{ initial} = 25\text{ }^{\circ}\text{C}$ ). Rectangular waveform  $t_p = 2.5\text{ } \mu\text{s}$

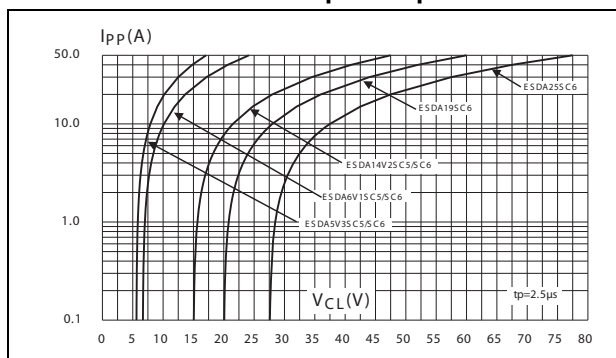

Figure 6. Capacitance versus reverse applied voltage

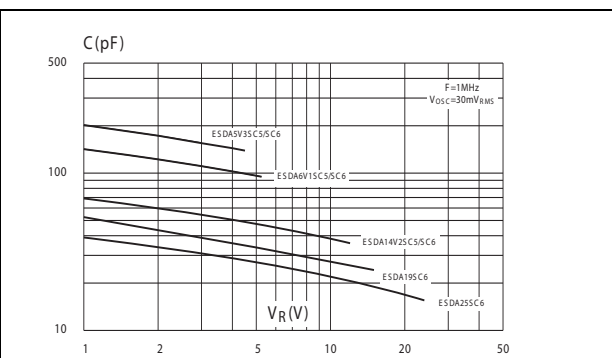

Figure 7. Relative variation of leakage current versus junction temperature

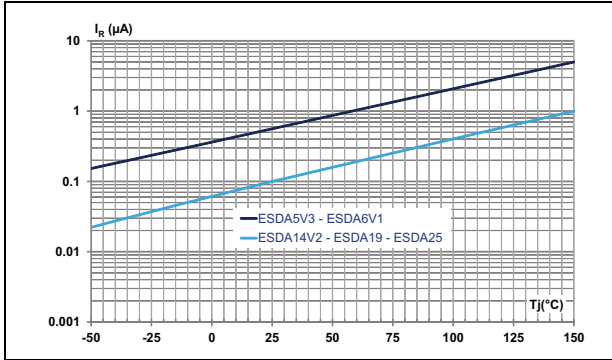
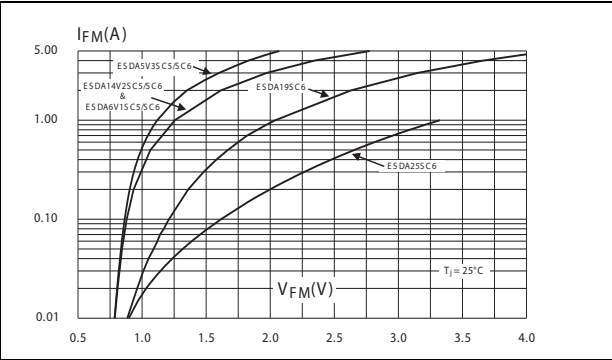
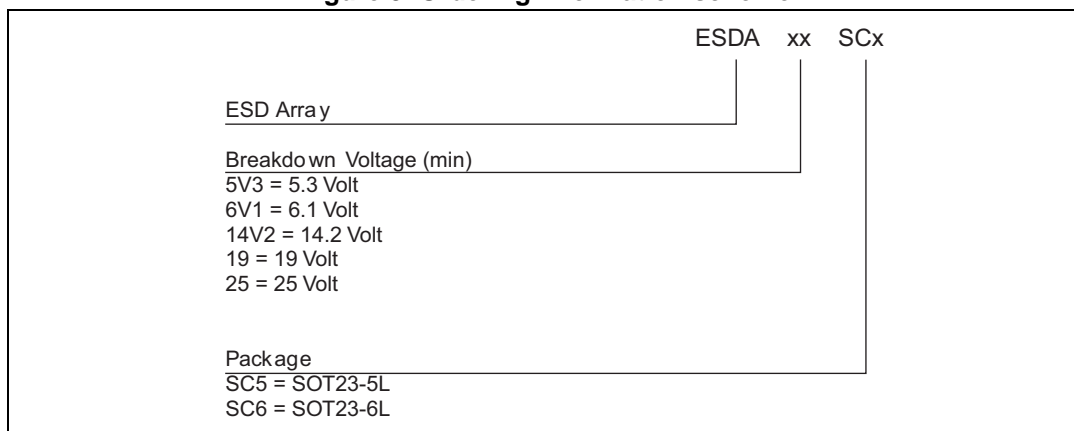

Figure 8. Peak forward voltage drop versus peak forward current



## 2 Ordering information

Figure 9. Ordering information scheme



### 3 Package information

- Epoxy meets UL94, V0 standard

In order to meet environmental requirements, ST (also) offers these devices in ECOPACK® packages. ECOPACK® packages are Lead-free. The category of second level Interconnect is marked on the inner box label, in compliance with JEDEC Standard JESD97. The maximum ratings related to soldering conditions are also marked on the inner box label.

ECOPACK is an ST trademark. ECOPACK specifications are available at: [www.st.com](http://www.st.com).

**Table 5. SOT23-5L dimensions**

Ref.	Dimensions					
	Millimeters			Inches		
	Min.	Typ.	Max.	Min.	Typ.	Max.
A	0.90		1.45	0.035		0.057
A1	0		0.10	0		0.004
A2	0.90		1.30	0.035		0.051
b	0.35		0.50	0.014		0.020
c	0.09		0.20	0.004		0.008
D	2.80		3.05	0.11		0.118
E	1.50		1.75	0.059		0.069
e		0.95			0.037	
H	2.60		3.00	0.102		0.118
L	0.10		0.60	0.004		0.024
M	0°		10°	0°		10°

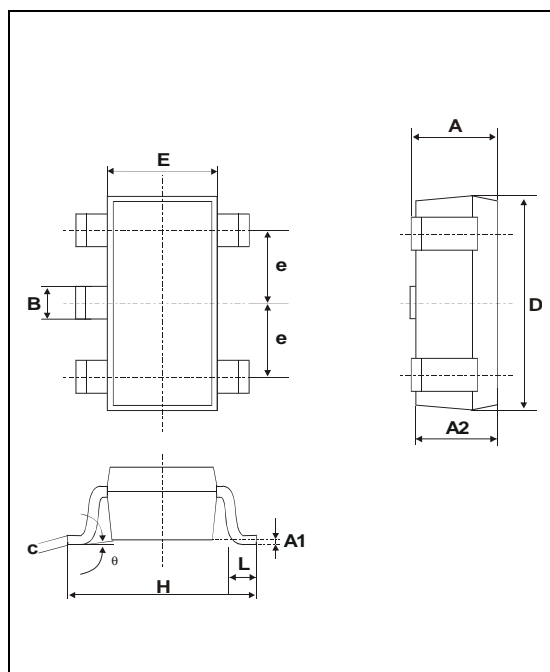

**Figure 10. SOT23-5L footprint (dimensions in mm)**

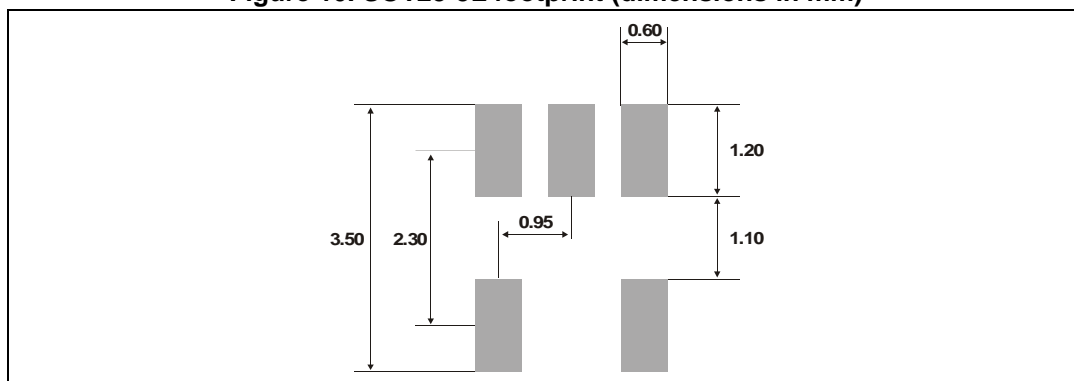
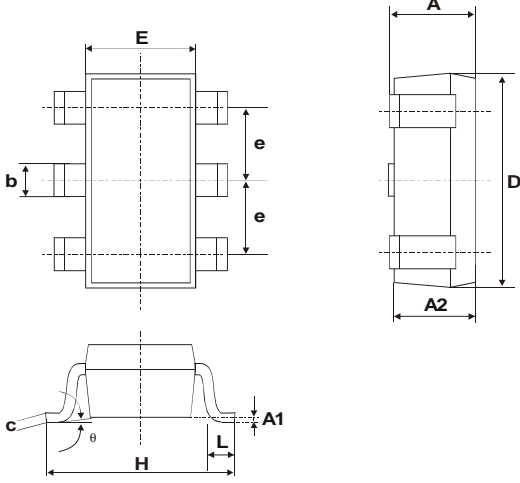
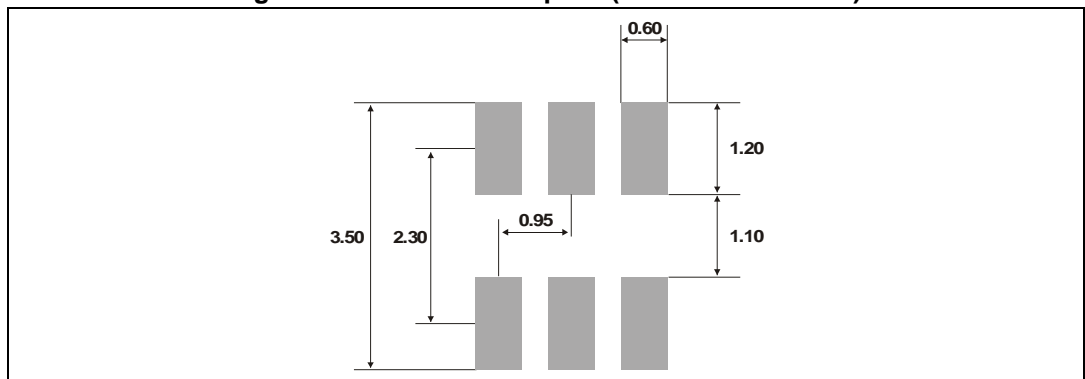

Table 6. SOT23-6L dimensions



Ref.	Dimensions					
	Millimeters			Inches		
	Min.	Typ.	Max.	Min.	Typ.	Max.
A	0.90		1.45	0.035		0.057
A1	0		0.10	0		0.004
A2	0.90		1.30	0.035		0.051
b	0.35		0.50	0.014		0.020
c	0.09		0.20	0.004		0.008
D	2.80		3.05	0.11		0.118
E	1.50		1.75	0.059		0.069
e		0.95			0.037	
H	2.60		3.00	0.102		0.118
L	0.10		0.60	0.004		0.024
$\theta$	0°		10°	0°		10°

Figure 11. SOT23-6L footprint (dimensions in mm)



## 4 Ordering information

Table 7. Ordering information

Order codes	Marking	Package	Weight	Base qty	Delivery mode
ESDA5V3SC5	EC53	SOT23-5L	16.7 mg	3000	Tape and reel
ESDA6V1SC5	EC61				
ESDA14V2SC5	EC15				
ESDA5V3SC6	ES53	SOT23-6L			
ESDA6V1SC6	ES61				
ESDA14V2SC6	ES15				
ESDA19SC6	ES19				
ESDA25SC6	ES25				

## 5 Revision history

Table 8. Document revision history

Date	Revision	Description of changes
Nov-2003	7F	Previous issue.
4-Nov-2004	8	SOT23-6L package dimensions change for reference "D" from 3.0 millimeters (0.118 inches) to 3.05 millimeters (0.120 inches).
22-Nov-2007	9	Reformatted to current standard. Units for $I_{RM}$ MAX in <a href="#">Table 4</a> corrected to $\mu A$ . <a href="#">Ordering information scheme</a> expanded to cover all devices. Package information for SOT23-5L updated.
17-Aug-2015	10	Updated features on cover page. Updated <a href="#">Table 2</a> , <a href="#">Table 4</a> , <a href="#">Figure 4</a> , <a href="#">Figure 5</a> , <a href="#">Figure 6</a> , <a href="#">Figure 7</a> , <a href="#">Figure 8</a> , <a href="#">Figure 9</a> and <a href="#">Table 7</a> . Removed section "Application information" and "Technical information".



**IMPORTANT NOTICE – PLEASE READ CAREFULLY**

STMicroelectronics NV and its subsidiaries ("ST") reserve the right to make changes, corrections, enhancements, modifications, and improvements to ST products and/or to this document at any time without notice. Purchasers should obtain the latest relevant information on ST products before placing orders. ST products are sold pursuant to ST's terms and conditions of sale in place at the time of order acknowledgement.

Purchasers are solely responsible for the choice, selection, and use of ST products and ST assumes no liability for application assistance or the design of Purchasers' products.

No license, express or implied, to any intellectual property right is granted by ST herein.

Resale of ST products with provisions different from the information set forth herein shall void any warranty granted by ST for such product.

ST and the ST logo are trademarks of ST. All other product or service names are the property of their respective owners.

Information in this document supersedes and replaces information previously supplied in any prior versions of this document.

© 2015 STMicroelectronics – All rights reserved

## X-ON Electronics

Largest Supplier of Electrical and Electronic Components

*Click to view similar products for [ESD Suppressors / TVS Diodes](#) category:*

*Click to view products by [STMicroelectronics](#) manufacturer:*

Other Similar products are found below :

[60KS200C](#) [D12V0H1U2WS-7](#) [D18V0L1B2LP-7B](#) [82356050220](#) [D5V0M5U6V-7](#) [NTE4902](#) [P4KE27CA](#) [P6KE11CA](#) [P6KE39CA-TP](#)  
[P6KE8.2A](#) [SA110CA](#) [SA60CA](#) [SA64CA](#) [SMBJ12CATR](#) [SMBJ8.0A](#) [SMLJ30CA-TP](#) [ESD101-B1-02ELS E6327](#) [ESD112-B1-02EL E6327](#)  
[ESD119B1W01005E6327XTSA1](#) [ESD5V0J4-TP](#) [ESD5V0L1B02VH6327XTSA1](#) [ESD7451N2T5G](#) [19180-510](#) [CPDT-5V0USP-HF](#)  
[3.0SMCJ33CA-F](#) [3.0SMCJ36A-F](#) [HSPC16701B02TP](#) [D3V3Q1B2DLP3-7](#) [D55V0M1B2WS-7](#) [DESD5V0U1BL-7B](#) [DRTR5V0U4SL-7](#)  
[SCM1293A-04SO](#) [ESD200-B1-CSP0201 E6327](#) [ESD203-B1-02EL E6327](#) [SM12-7](#) [SMF8.0A-TP](#) [SMLJ45CA-TP](#) [CEN955 W/DATA](#)  
[82350120560](#) [82356240030](#) [VESD12A1A-HD1-GS08](#) [CPDUR5V0R-HF](#) [CPDUR24V-HF](#) [CPDQC5V0U-HF](#) [CPDQC5V0USP-HF](#)  
[CPDQC5V0-HF](#) [D1213A-01LP4-7B](#) [D1213A-02WL-7](#) [ESDLIN1524BJ-HQ](#) [5KP100A](#)