

Automotive single-line Transil™, transient voltage suppressor (TVS) for LIN bus

Datasheet - production data

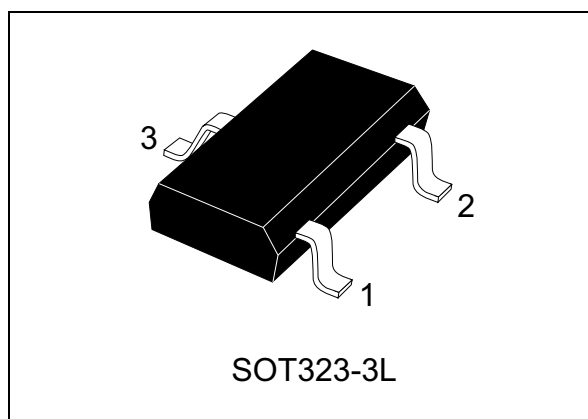

Complies with the following standards

- ISO 10605 - C = 150 pF, R = 330 Ω :
 - ±30 kV (air discharge)
 - ±30 kV (contact discharge)
- ISO 10605 - C = 330 pF, R = 330 Ω :
 - ±30 kV (air discharge)
 - ±30 kV (contact discharge)
- ISO 7637-3:
 - Pulse 3a: $V_s = -150\text{ V}$
 - Pulse 3b: $V_s = +100\text{ V}$

Application

LIN bus lines where electrostatic discharge and other transients must be suppressed. This product is compliant with most of automotive interfaces.

Description

The ESDLIN03-1BWY is a single-line Transil specifically designed for the protection of the automotive LIN bus lines against electrostatic discharge (ESD) and transient voltages.

Figure 1. Functional schematic

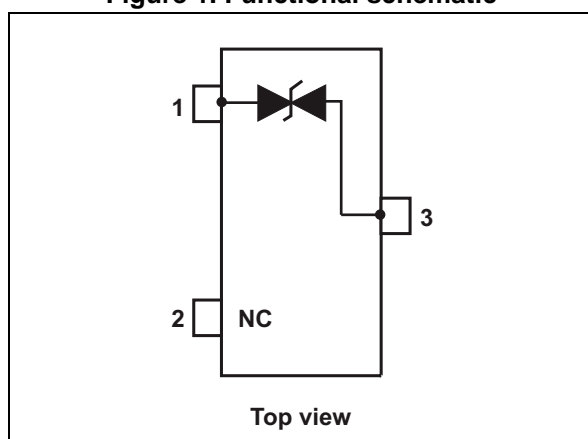

Features

- Single-line ESD and EOS protection
- Stand-off voltage: 26.5 V
- Bidirectional device
- Max pulse power: 250 W (8/20 μs)
- Low clamping factor V_{CL} / V_{BR}
- Low leakage current
- ECOPACK®2 compliant component
- AEC-Q101 qualified

TM: Transil is a trademark of STMicroelectronics

1 Characteristics

Table 1. Absolute maximum ratings ($T_{amb} = 25^{\circ}\text{C}$)

Symbol	Parameter		Value	Unit
V_{PP}	Electrostatic discharge capability	ISO 10605 - C = 150 pF, R = 330 Ω :		kV
		Contact discharge	30	
		Air discharge	30	
		ISO 10605 - C = 330 pF, R = 330 Ω :		
	Contact discharge	30		
	Air discharge	30		
	HBM MIL STD 883	30		
P_{PP}	Peak pulse power dissipation (8/20 μs)	$T_j \text{ initial} = T_{amb}$	250	W
I_{PP}	Peak pulse current (8/20 μs)		3.7	A
T_j	Operating junction temperature range		-55 to +175	$^{\circ}\text{C}$
T_{stg}	Storage temperature range		-55 to +175	$^{\circ}\text{C}$

Figure 2. Electrical characteristics (definitions)

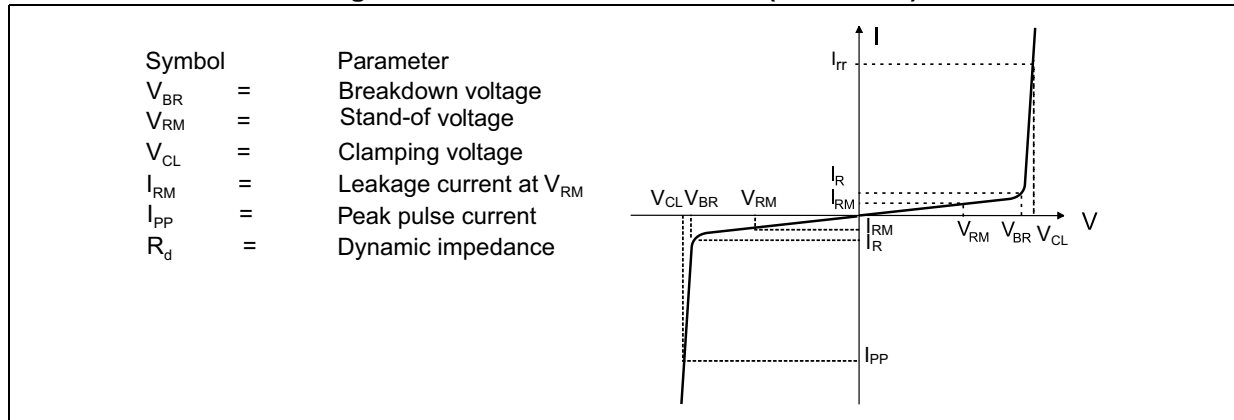

Table 2. Electrical characteristics (values, $T_{amb} = 25\text{ }^{\circ}\text{C}$)

Symbol	Test conditions	Min.	Typ.	Max.	Unit
V_{RM}	ESDLIN03-1BWY			26.5	V
V_{BR}	$I_R = 1\text{ mA}$	28.5			V
I_{RM}	$V_{RM} = 24\text{ V}$			10	nA
	$V_{RM} = 5\text{ V}$			1	
	$V_{RM} = 24\text{ V}$			50	
	$V_{RM} = 5\text{ V}$			10	
V_{CL}	ISO 7637-3 Pulse 3a ($U_s = -150\text{ V}$)	-39			V
	ISO 7637-3 Pulse 3b ($U_s = +100\text{ V}$)			39	
	IEC 61000-4-5 (8/20 μs), $I_{PP} = 1\text{ A}$			37	
	IEC 61000-4-5 (8/20 μs), $I_{PP} = 3\text{ A}$			44	
C	$V_R = 0\text{ V DC}$, $f = 1\text{ MHz}$		3	3.5	pF
$\alpha T^{(1)}$	Voltage temperature coefficient			9	$10^{-4}/^{\circ}\text{C}$

1. V_{BR} at $T_j = V_{BR}$ at $25^{\circ}\text{C} \times (1 + \alpha T \times (T_j - 25))$

Figure 3. Peak pulse current versus initial junction temperature (maximum values)

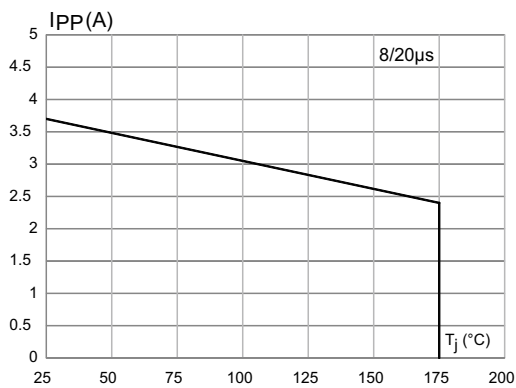

Figure 4. Junction capacitance versus reverse voltage applied

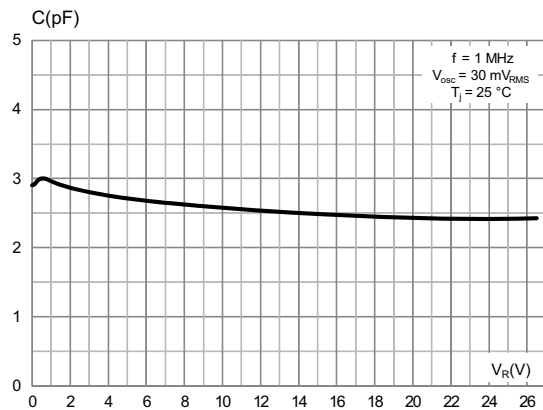

Figure 5. Peak pulse current versus clamping voltage

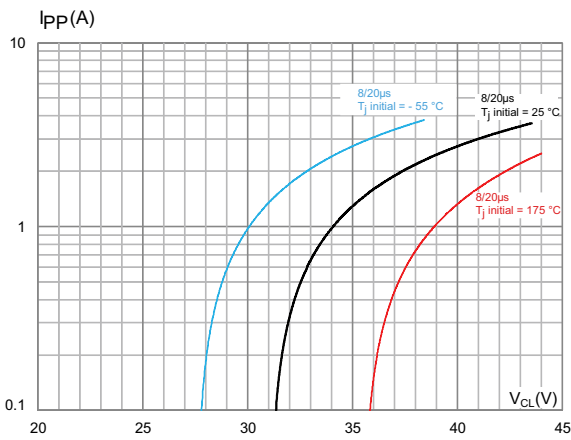

Figure 6. Leakage current versus junction temperature

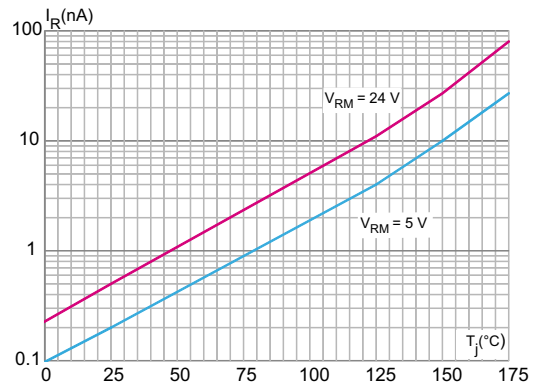

Figure 7. S21 attenuation measurement

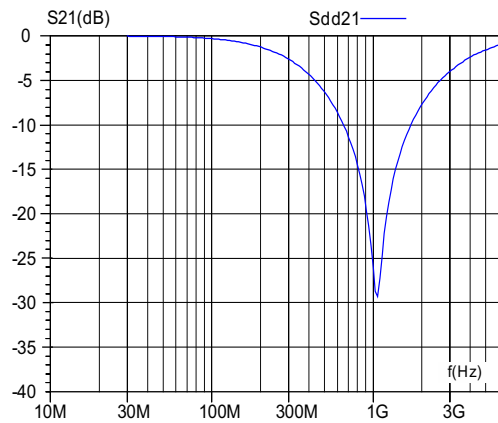

Figure 8. ESD response to ISO 10605 - C = 150 pF, R = 330 Ω (+8 kV contact)

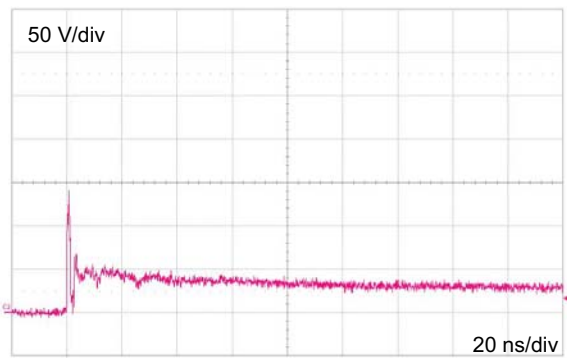

Figure 9. ESD response to ISO 10605 - C = 150 pF, R = 330 Ω (-8 kV contact)

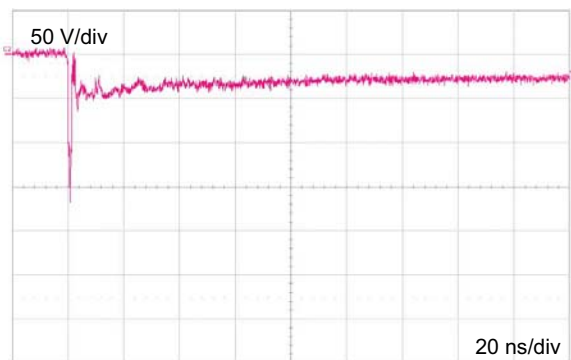

Figure 10. Response to ISO 7637-3 Pulse 3a (U_s = -150 V)

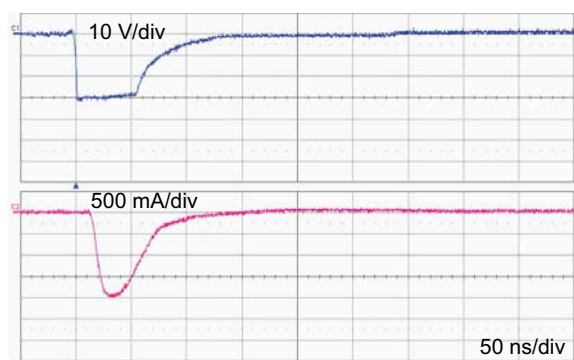

Figure 11. Response to ISO 7637-3 Pulse 3b
($U_s = +100\text{ V}$)

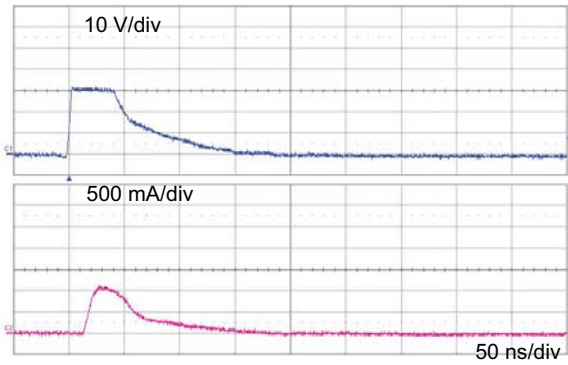
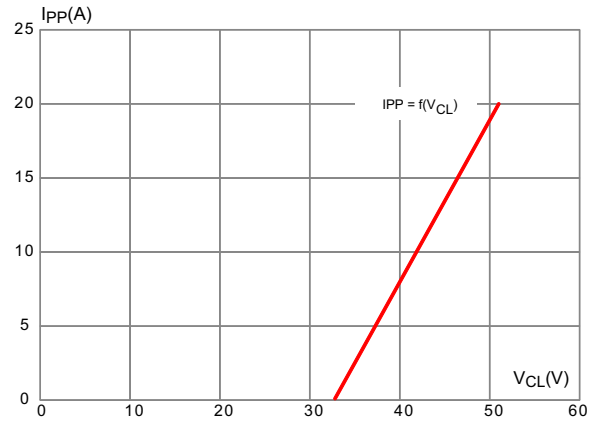

Figure 12. TLP measurements



2 Package information

- Epoxy meets UL94, V0
- Lead-free packages

In order to meet environmental requirements, ST offers these devices in different grades of ECOPACK® packages, depending on their level of environmental compliance. ECOPACK® specifications, grade definitions and product status are available at: www.st.com. ECOPACK® is an ST trademark.

2.1 SOT323-3L package information

Figure 13. SOT323-3L package outline

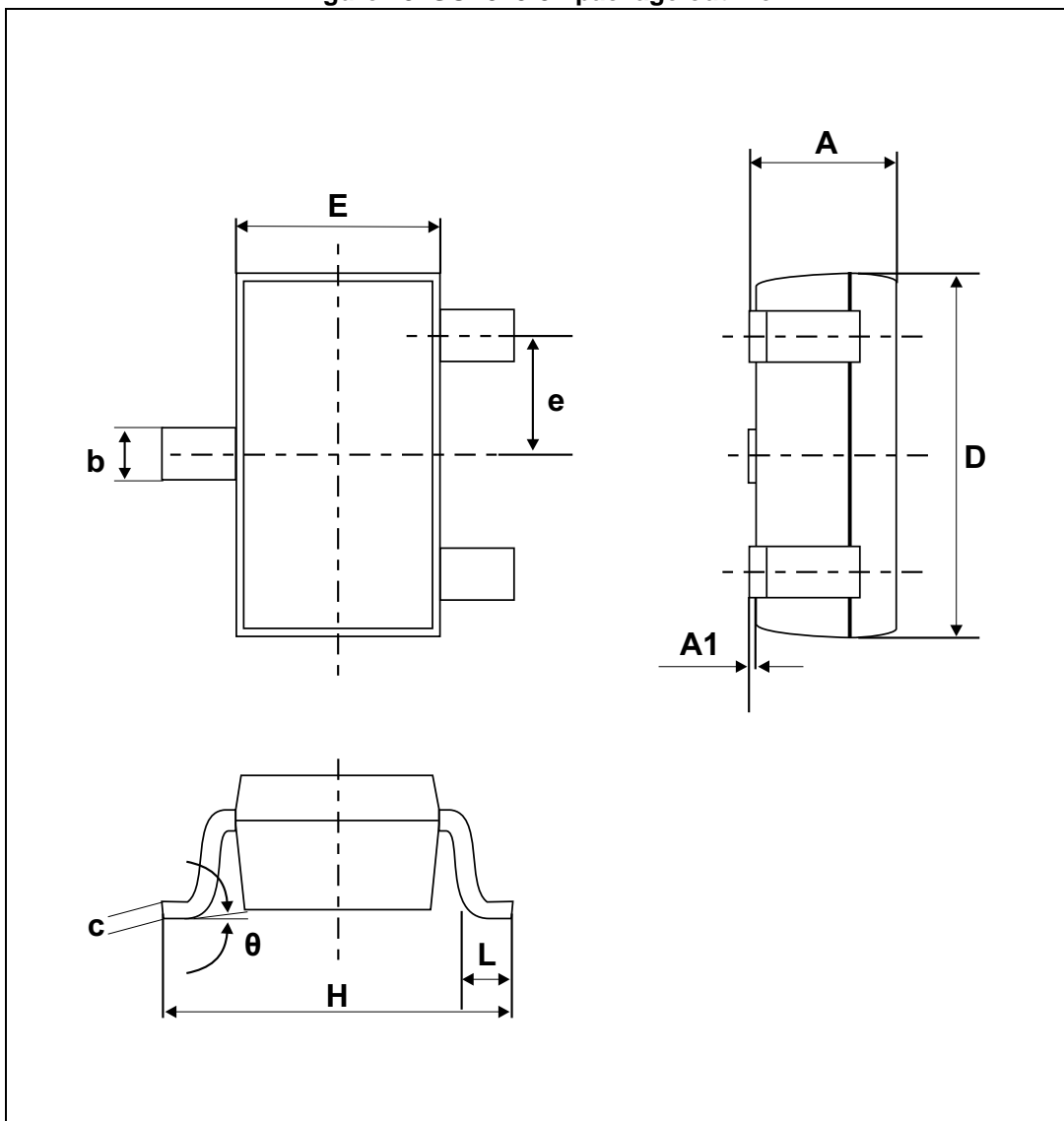
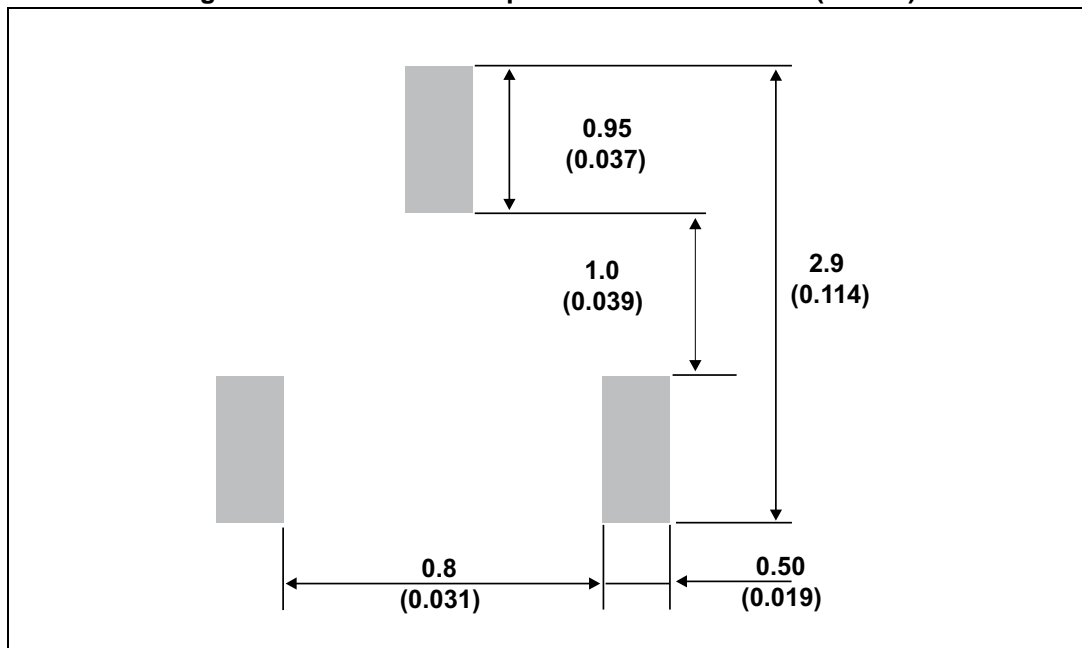

Table 3. SOT323-3L package mechanical data

Ref.	Dimensions					
	Millimeters			Inches ⁽¹⁾		
	Min.	Typ.	Max.	Min.	Typ.	Max.
A	0.8		1.1	0.031		0.043
A1	0.0		0.1	0.0		0.004
b	0.25		0.4	0.01		0.016
c	0.1		0.26	0.004		0.01
D	1.8	2.0	2.2	0.071	0.079	0.086
E	1.15	1.25	1.35	0.045	0.049	0.053
e		0.65			0.026	
H	1.8	2.1	2.4	0.071	0.083	0.094
L	0.1	0.2	0.3	0.004	0.008	0.012
Θ	0		30°	0		30°

1. Values in inches are converted from mm and rounded to 4 decimal digits.

Figure 14. SOT323-3L footprint dimensions in mm (inches)



2.2 PCB design preference

1. To control the solder paste amount, the closed via is recommended instead of open vias.
2. The position of tracks and open vias in the solder area should be well balanced. The symmetrical layout is recommended, in case any tilt phenomena caused by asymmetrical solder paste amount due to the solder flow away.

2.3 Reflow profile

Figure 15. ST ECOPACK® recommended soldering reflow profile for PCB mounting

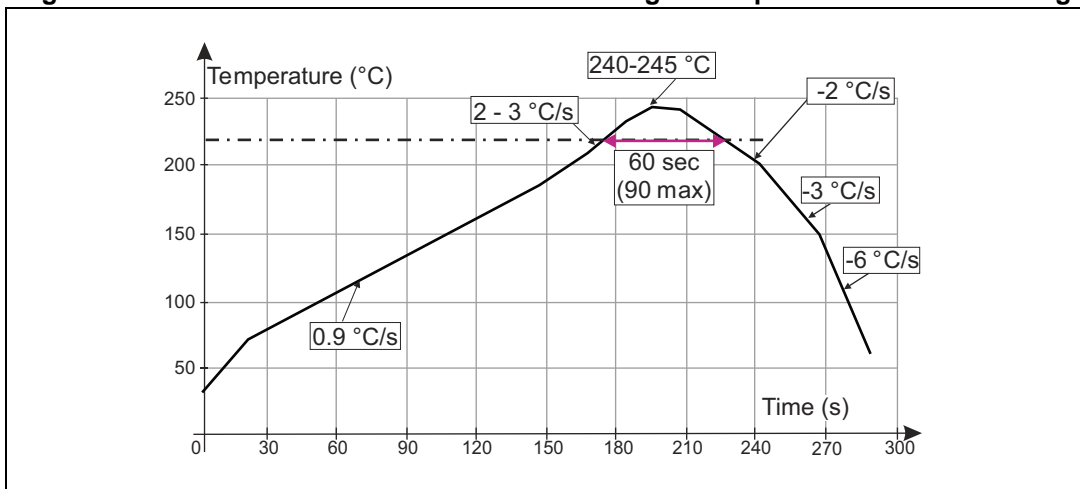

Minimize air convection currents in the reflow oven to avoid component movement.
Maximum soldering profile corresponds to the latest IPC/JEDEC J-STD-020.

3 Ordering information

Figure 16. Ordering information scheme

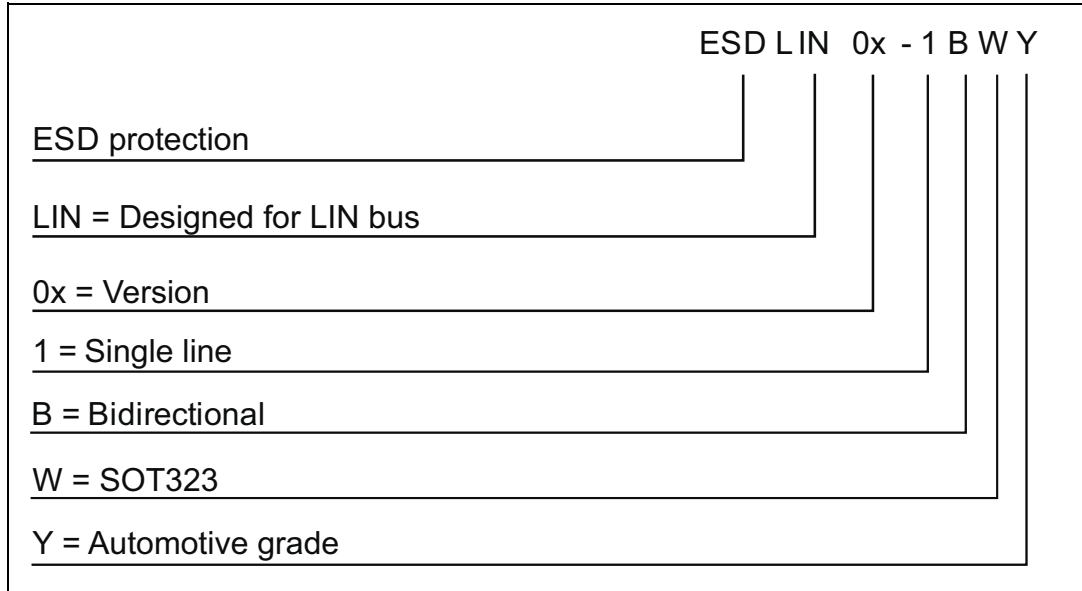

Table 4. Ordering information

Order code	Marking	Package	Weight	Base qty	Delivery mode
ESDLIN03-1BWY	C12	SOT-323-3L	6.58 mg	3000	Tape and reel

4 Revision history

Table 5. Document revision history

Date	Revision	Changes
05-Jan-2016	1	Initial release.

IMPORTANT NOTICE – PLEASE READ CAREFULLY

STMicroelectronics NV and its subsidiaries (“ST”) reserve the right to make changes, corrections, enhancements, modifications, and improvements to ST products and/or to this document at any time without notice. Purchasers should obtain the latest relevant information on ST products before placing orders. ST products are sold pursuant to ST’s terms and conditions of sale in place at the time of order acknowledgement.

Purchasers are solely responsible for the choice, selection, and use of ST products and ST assumes no liability for application assistance or the design of Purchasers’ products.

No license, express or implied, to any intellectual property right is granted by ST herein.

Resale of ST products with provisions different from the information set forth herein shall void any warranty granted by ST for such product.

ST and the ST logo are trademarks of ST. All other product or service names are the property of their respective owners.

Information in this document supersedes and replaces information previously supplied in any prior versions of this document.

© 2016 STMicroelectronics – All rights reserved

X-ON Electronics

Largest Supplier of Electrical and Electronic Components

Click to view similar products for [ESD Suppressors / TVS Diodes](#) category:

Click to view products by [STMicroelectronics](#) manufacturer:

Other Similar products are found below :

[60KS200C](#) [D12V0H1U2WS-7](#) [D18V0L1B2LP-7B](#) [82356050220](#) [D5V0M5U6V-7](#) [NTE4902](#) [P4KE27CA](#) [P6KE11CA](#) [P6KE39CA-TP](#)
[P6KE8.2A](#) [SA110CA](#) [SA60CA](#) [SA64CA](#) [SMBJ12CATR](#) [SMBJ8.0A](#) [SMLJ30CA-TP](#) [ESD101-B1-02ELS E6327](#) [ESD112-B1-02EL E6327](#)
[ESD119B1W01005E6327XTSA1](#) [ESD5V0J4-TP](#) [ESD5V0L1B02VH6327XTSA1](#) [ESD7451N2T5G](#) [19180-510](#) [CPDT-5V0USP-HF](#)
[3.0SMCJ33CA-F](#) [3.0SMCJ36A-F](#) [HSPC16701B02TP](#) [D3V3Q1B2DLP3-7](#) [D55V0M1B2WS-7](#) [DESD5V0U1BL-7B](#) [DRTR5V0U4SL-7](#)
[SCM1293A-04SO](#) [ESD200-B1-CSP0201 E6327](#) [ESD203-B1-02EL E6327](#) [SM12-7](#) [SMF8.0A-TP](#) [SMLJ45CA-TP](#) [CEN955 W/DATA](#)
[82350120560](#) [82356240030](#) [VESD12A1A-HD1-GS08](#) [CPDUR5V0R-HF](#) [CPDUR24V-HF](#) [CPDQC5V0U-HF](#) [CPDQC5V0USP-HF](#)
[CPDQC5V0-HF](#) [D1213A-01LP4-7B](#) [D1213A-02WL-7](#) [ESDLIN1524BJ-HQ](#) [5KP100A](#)