

Ultra low clamping single line bidirectional ESD protection

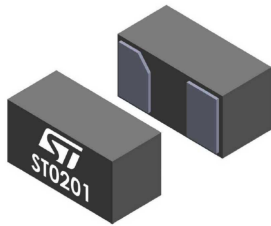

0201 package

Figure 1. Functional diagram

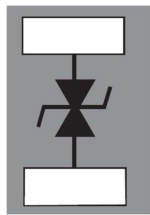

Features

- Ultra low clamping voltage: 7 V (IEC 61000-4-2 contact discharge 8 kV at 30 ns / 16 A TLP)
- Bidirectional device
- Low leakage current
- 0201 package
- ECOPACK2 compliant component
- Exceeds the following standard:
 - IEC 61000-4-2 level 4 = ± 30 kV (air discharge) and ± 18 kV (contact discharge)

Application

Where transient over voltage protection in ESD sensitive equipment is required, such as:

- Smartphones, mobile phones and accessories
- Tablets and notebooks
- Portable multimedia devices and accessories
- Wearable, home automation, healthcare
- Highly integrated systems

Description

The ESDZV5-1BF4 is a bidirectional single line TVS diode designed to protect the data line or other I/O ports against ESD transients.

The device is ideal for applications where both reduced line capacitance and board space saving are required.

Product status

ESDZV5-1BF4

1 Characteristics

Table 1. Absolute ratings ($T_{amb} = 25\text{ }^{\circ}\text{C}$)

Symbol	Parameter	Value	Unit
V_{PP}	Peak pulse voltage	Contact discharge	18
		Air discharge	30
P_{PP}	Peak pulse power dissipation (8/20 μs)	70	W
I_{PP}	Peak pulse current (8/20 μs)	7	A
T_j	Operating junction temperature range	-55 to +150	$^{\circ}\text{C}$
T_{stg}	Storage temperature range	-65 to +150	$^{\circ}\text{C}$
T_L	Maximum lead temperature for soldering during 10 s	260	$^{\circ}\text{C}$

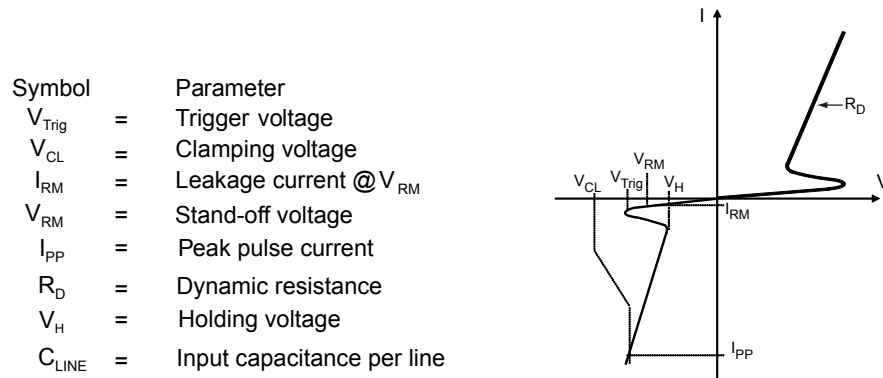
Figure 2. Electrical characteristics (definitions)

Table 2. Electrical characteristics ($T_{amb} = 25\text{ }^{\circ}\text{C}$)

Symbol	Test condition	Min.	Typ.	Max.	Unit
V_{Trig}	Higher voltage than V_{Trig} guarantees the protection turn-on	5.8		10	V
V_H	Lower voltage than V_H guarantees the protection turn-off	4	4.6		
I_{RM}	$V_{RM} = 5.5\text{ V}^{(1)}$			100	nA
V_{CL}	8 kV contact discharge after 30 ns, IEC 61000-4-2		7		V
V_{CL}	8/20 μs waveform, $I_{PP} = 7\text{ A}$			10	V
C_{LINE}	$F = 1\text{ MHz}$, $V_{LINE} = 0\text{ V}$, $V_{OSC} = 30\text{ mV}$		6	7.5	pF
R_D	Pulse duration 100 ns		0.18		Ω

1. Application note: when used to protect a line connected to a DC source, the DC voltage must be lower than the minimum V_H to enable the diode to return to its non-conducting state after the transient.

1.1 Characteristics (curves)

Figure 3. Leakage current versus junction temperature (typical values)

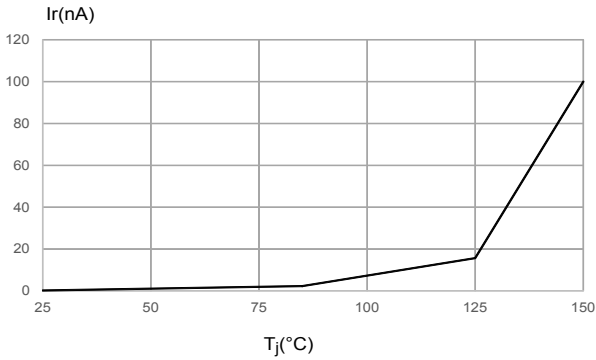

Figure 4. Junction capacitance versus reverse voltage applied (typical values)

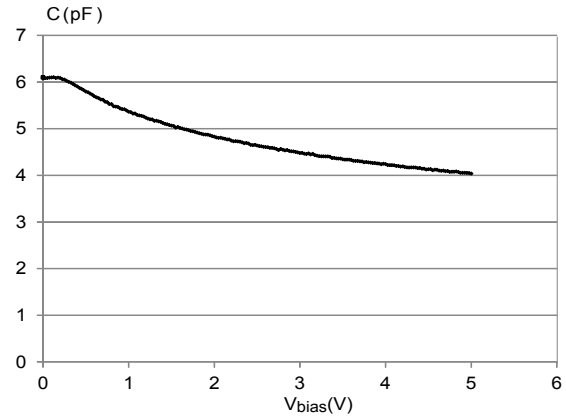

Figure 5. ESD response to IEC 61000-4-2 (+8 kV contact discharge)

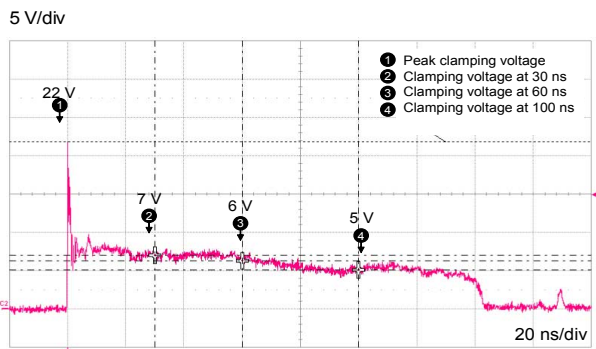

Figure 6. ESD response to IEC 61000-4-2 (-8 kV contact discharge)

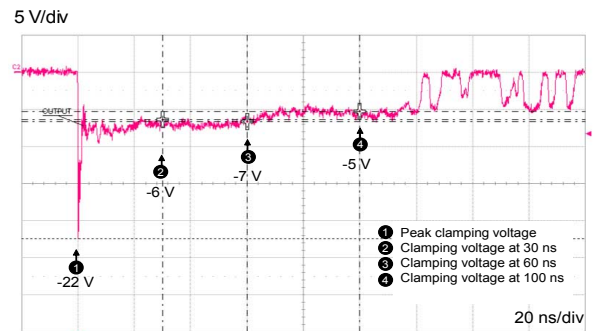

Figure 7. TLP characteristic

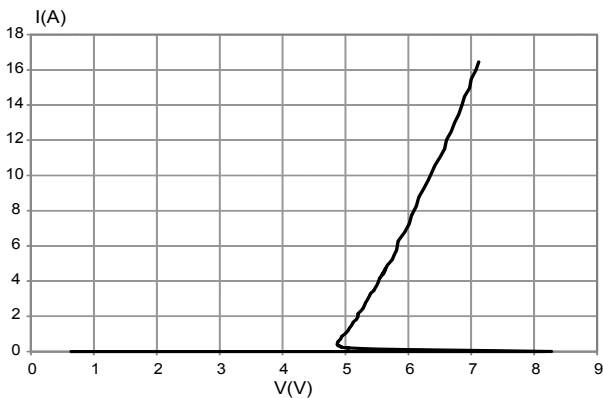
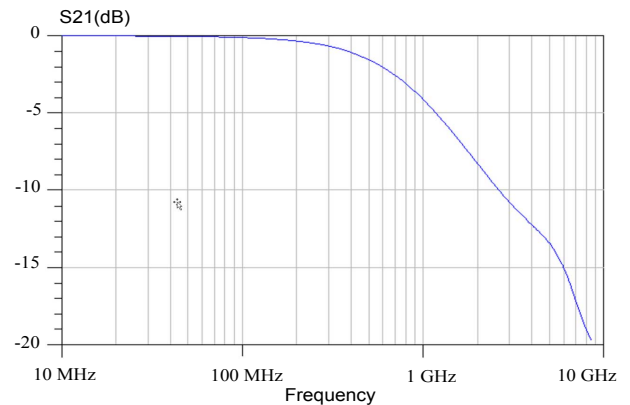

Figure 8. S21 attenuation measurement result



2 Package information

In order to meet environmental requirements, ST offers these devices in different grades of **ECOPACK** packages, depending on their level of environmental compliance. ECOPACK specifications, grade definitions and product status are available at: www.st.com. ECOPACK is an ST trademark.

2.1 0201 package information

Figure 9. 0201 package outline

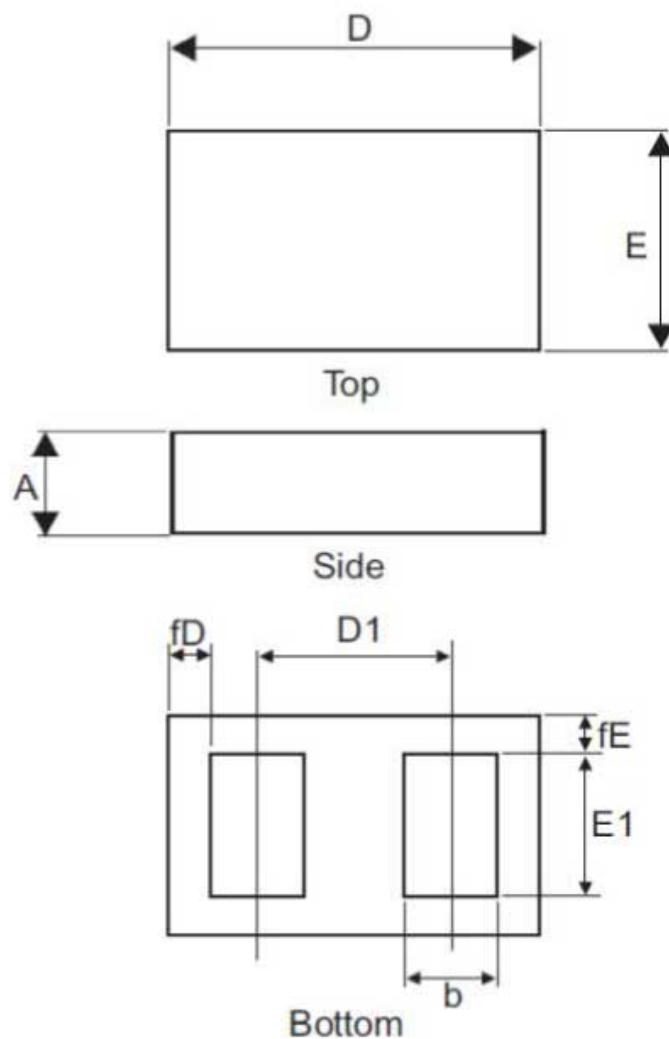

Note: *The marking codes can be rotated by 90 ° or 180° to differentiate assembly location. In no case should this product marking be used to orient the component for its placement on a PCB. Only pin 1 mark is to be used for this purpose.*

Table 3. 0201 package mechanical data

Ref.	Dimensions		
	Millimeters		
	Min.	Typ.	Max.
A	0.270	0.300	0.330
b	0.1675	0.1875	0.2075
D	0.560	0.580	0.600
D1		0.3375	
E	0.260	0.280	0.300
E1	0.205	0.225	0.245
fD	0.0175	0.0275	0.0375
fE	0.0175	0.0275	0.0375

Figure 10. Marking



Note: The marking can be rotated by multiples of 90° to differentiate assembly location.

Figure 11. Tape and reel specification (in mm)

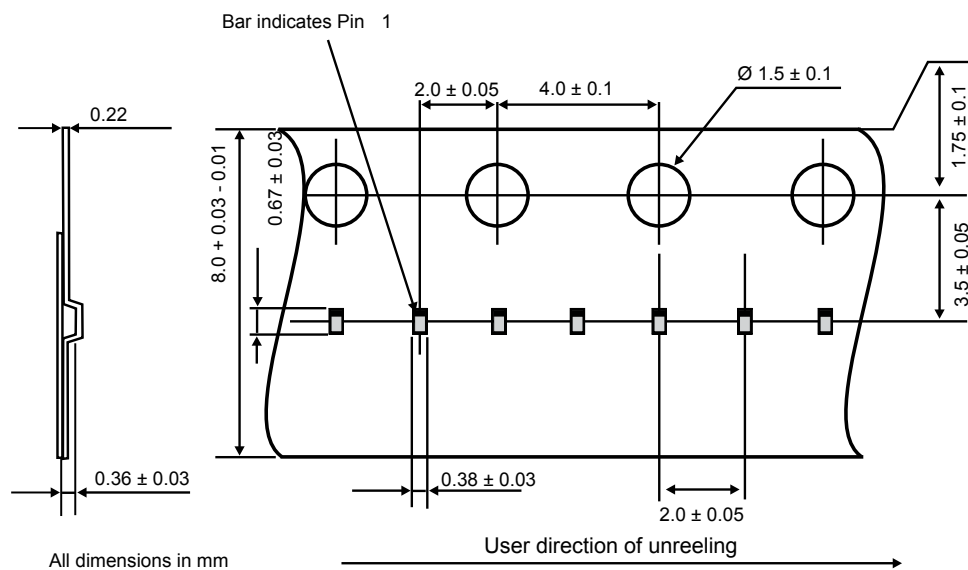

3 Recommendation on PCB assembly

3.1 Footprint

Figure 12. Recommended footprint in mm

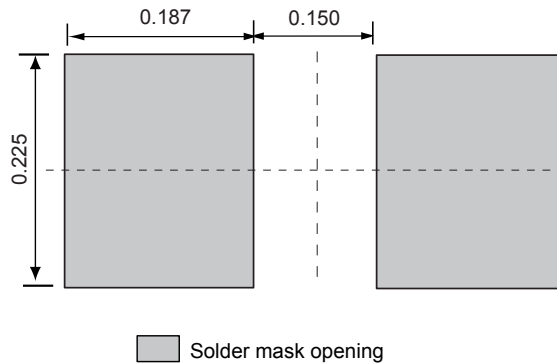

3.2 Stencil opening design

1. Reference design
 - a. Stencil opening thickness: 75 μm / 3 mils

Figure 13. Recommended stencil window position in mm

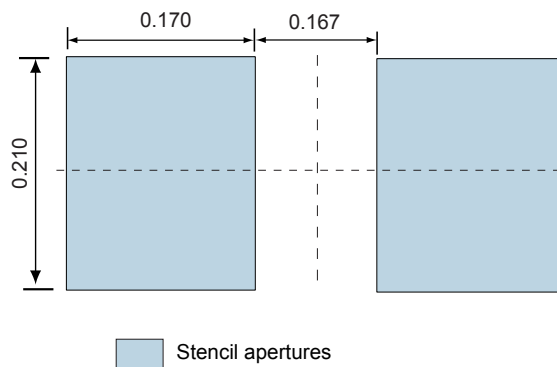

3.3 Solder paste

1. Halide-free flux qualification ROL0 according to ANSI/J-STD-004.
2. “No clean” solder paste is recommended.
3. Offers a high tack force to resist component movement during high speed.
4. Use solder paste with fine particles: powder particle size 20-38 μm .

3.4 Placement

1. Manual positioning is not recommended.
2. It is recommended to use the lead recognition capabilities of the placement system, not the outline centering
3. Standard tolerance of ± 0.05 mm is recommended.
4. 1.0 N placement force is recommended. Too much placement force can lead to squeezed out solder paste and cause solder joints to short. Too low placement force can lead to insufficient contact between package and solder paste that could cause open solder joints or badly centered packages.
5. To improve the package placement accuracy, a bottom side optical control should be performed with a high resolution tool.
6. For assembly, a perfect supporting of the PCB (all the more on flexible PCB) is recommended during solder paste printing, pick and place and reflow soldering by using optimized tools.

3.5 PCB design preference

1. To control the solder paste amount, the closed via is recommended instead of open vias.
2. The position of tracks and open vias in the solder area should be well balanced. A symmetrical layout is recommended, to avoid any tilt phenomena caused by asymmetrical solder paste due to solder flow away.

3.6 Reflow profile

Figure 14. ST ECOPACK recommended soldering reflow profile for PCB mounting

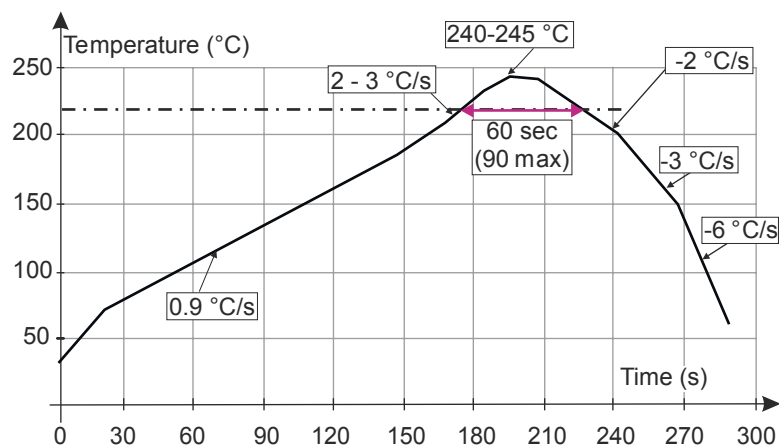

Note: Minimize air convection currents in the reflow oven to avoid component movement. Maximum soldering profile corresponds to the latest IPC/JEDEC J-STD-020.

4 Ordering information

Figure 15. Ordering information scheme

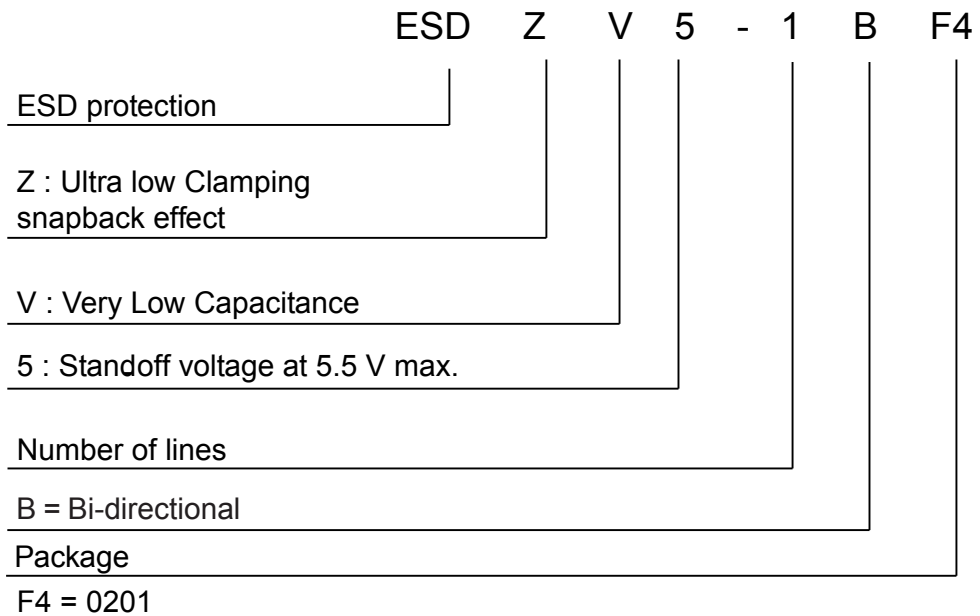

Table 4. Ordering information

Order code	Marking	Package	Weight	Base qty.	Delivery mode
ESDZV5-1BF4	A ⁽¹⁾	0201	0.116 mg	15000	Tape and reel

1. The marking can be rotated by multiples of 90° to differentiate assembly location

Revision history

Table 5. Document revision history

Date	Revision	Changes
06-Apr-2017	1	First issue.
28-Jul-2017	2	Updated footprint title.
19-Jan-2022	3	Updated Figure 12 . Minor text changes.

IMPORTANT NOTICE – PLEASE READ CAREFULLY

STMicroelectronics NV and its subsidiaries (“ST”) reserve the right to make changes, corrections, enhancements, modifications, and improvements to ST products and/or to this document at any time without notice. Purchasers should obtain the latest relevant information on ST products before placing orders. ST products are sold pursuant to ST’s terms and conditions of sale in place at the time of order acknowledgement.

Purchasers are solely responsible for the choice, selection, and use of ST products and ST assumes no liability for application assistance or the design of Purchasers’ products.

No license, express or implied, to any intellectual property right is granted by ST herein.

Resale of ST products with provisions different from the information set forth herein shall void any warranty granted by ST for such product.

ST and the ST logo are trademarks of ST. For additional information about ST trademarks, please refer to www.st.com/trademarks. All other product or service names are the property of their respective owners.

Information in this document supersedes and replaces information previously supplied in any prior versions of this document.

© 2022 STMicroelectronics – All rights reserved

X-ON Electronics

Largest Supplier of Electrical and Electronic Components

Click to view similar products for [ESD Suppressors / TVS Diodes](#) category:

Click to view products by [STMicroelectronics](#) manufacturer:

Other Similar products are found below :

[60KS200C](#) [D12V0H1U2WS-7](#) [D18V0L1B2LP-7B](#) [82356050220](#) [D5V0M5U6V-7](#) [NTE4902](#) [P4KE27CA](#) [P6KE11CA](#) [P6KE39CA-TP](#)
[P6KE8.2A](#) [SA110CA](#) [SA60CA](#) [SA64CA](#) [SMBJ12CATR](#) [SMBJ8.0A](#) [SMLJ30CA-TP](#) [ESD101-B1-02ELS E6327](#) [ESD112-B1-02EL E6327](#)
[ESD119B1W01005E6327XTSA1](#) [ESD5V0J4-TP](#) [ESD5V0L1B02VH6327XTSA1](#) [ESD7451N2T5G](#) [19180-510](#) [CPDT-5V0USP-HF](#)
[3.0SMCJ33CA-F](#) [3.0SMCJ36A-F](#) [HSPC16701B02TP](#) [D3V3Q1B2DLP3-7](#) [D55V0M1B2WS-7](#) [DESD5V0U1BL-7B](#) [DRTR5V0U4SL-7](#)
[SCM1293A-04SO](#) [ESD200-B1-CSP0201 E6327](#) [ESD203-B1-02EL E6327](#) [SM12-7](#) [SMF8.0A-TP](#) [SMLJ45CA-TP](#) [CEN955 W/DATA](#)
[82350120560](#) [82356240030](#) [VESD12A1A-HD1-GS08](#) [CPDUR5V0R-HF](#) [CPDUR24V-HF](#) [CPDQC5V0U-HF](#) [CPDQC5V0USP-HF](#)
[CPDQC5V0-HF](#) [D1213A-01LP4-7B](#) [D1213A-02WL-7](#) [ESDLIN1524BJ-HQ](#) [5KP100A](#)