



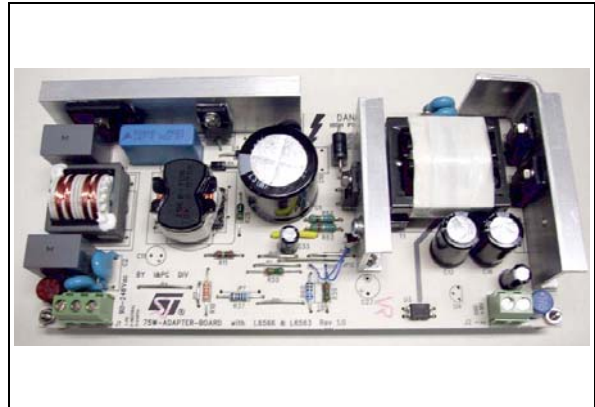
## EVL6566A-75WADP

19 V - 75 W laptop adapter with tracking boost  
PFC pre-regulator, using the L6563 and the L6566A

Data Brief

### Features

- Universal input mains range: 90÷264Vac - Frequency 45 ÷ 65 Hz
- Output voltage: 19 V@4 A continuous operation
- Mains harmonics: Acc. to EN61000-3-2 Class-D
- ST-by mains consumption: Less than 0.25 W @265Vac
- Overall efficiency: Better than 86%
- EMI: According to EN55022-Class-B
- Safety: According to EN60950
- Low profile design: 25 mm maximum height
- PCB single layer: single side, 70 µm, CEM-1, 78x174 mm, Mixed PTH/SMT



### Description

In this data brief of the EVL6566A-75WADP demo board, the main characteristics and features of a 75 W adapter wide-range input mains, power-factor-corrected AC-DC adapter using the new L6566A controller and the L6563 dedicated to the PFC stage are described.

High efficiency and the very low standby input consumption are highlighted in the following figures and tables. The board is programmed for working at fixed frequency (65 kHz) under nominal condition (19 V at 4 A).

On the secondary side the TSM1014 with a precise voltage reference and the optocoupler SFH617A-4 to transfer the error amplifiers information to the primary side have been used.

# 1 Efficiency

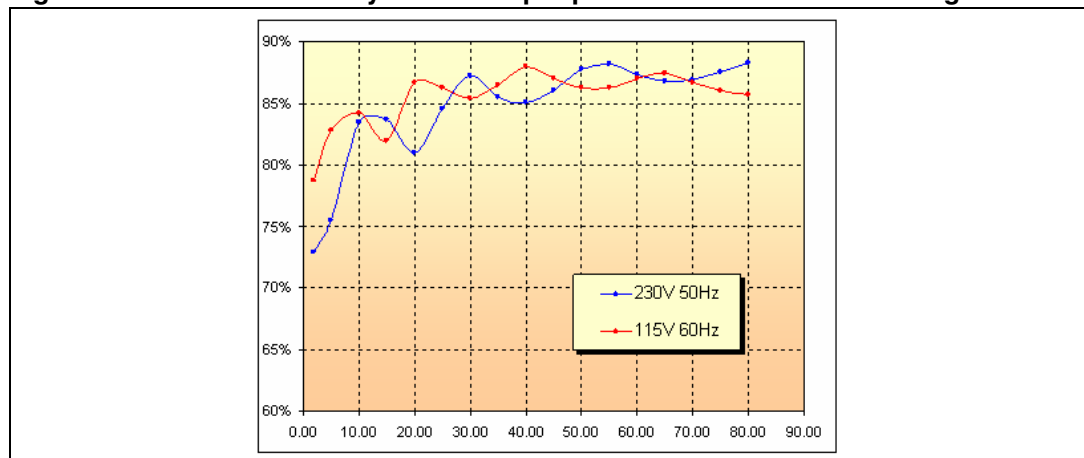
*Table 1* below shows the efficiency with two different input voltages. The table begins with the nominal load at 80 W on the output and it displays the efficiency at every power decrease of 5 W.

**Table 1. Efficiency measurements**

230 V-50 Hz			115 V-60 Hz		
Pin	Pout	Eff.	Pin	Pout	Eff.
85.73	75.05	87.5%	87.24	75.06	86.0%
80.56	70.00	86.9%	80.73	70.00	86.7%
74.91	65.01	86.8%	74.34	65.01	87.4%
68.68	59.97	87.3%	68.95	60.00	87.0%
62.40	55.01	88.2%	63.80	55.02	86.2%
56.96	50.00	87.8%	58.03	50.04	86.2%
52.31	45.02	86.1%	51.80	45.05	87.0%
47.03	40.00	85.1%	45.45	40.00	88.0%
41.01	35.05	85.5%	40.53	35.05	86.5%
34.40	30.00	87.2%	35.15	30.00	85.3%
29.60	25.02	84.5%	29.00	25.02	86.3%
24.70	20.00	81.0%	23.07	20.00	86.7%
17.86	14.94	83.7%	18.36	15.05	82.0%
11.98	10.00	83.5%	11.88	10.00	84.2%
6.64	5.01	75.5%	6.10	5.05	82.8%
2.73	1.99	72.9%	2.53	1.99	78.7%

Above the 20 W power output, the efficiency is constant over 85%.

**Figure 1. Overall efficiency versus output power at nominal mains voltages**



## 2 Full load

Figure 2 and Figure 3 below show the drain and gate fly-back waveforms and the relevant switching frequency at full load.

Figure 2. L6566A fly-back stage waveforms at 115 V-60 Hz full load

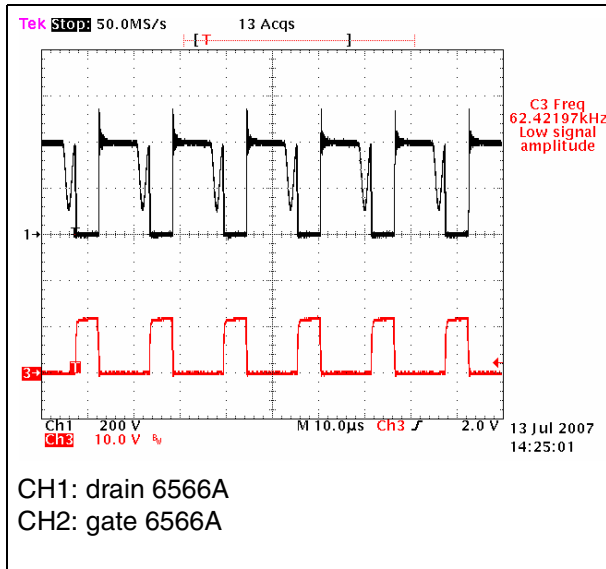
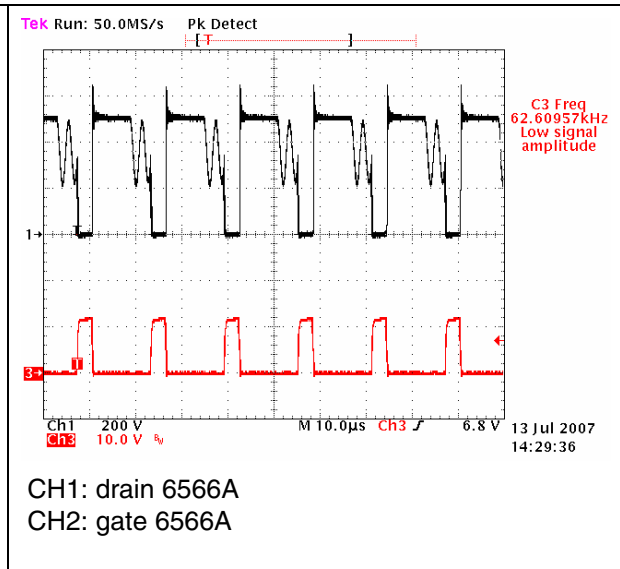


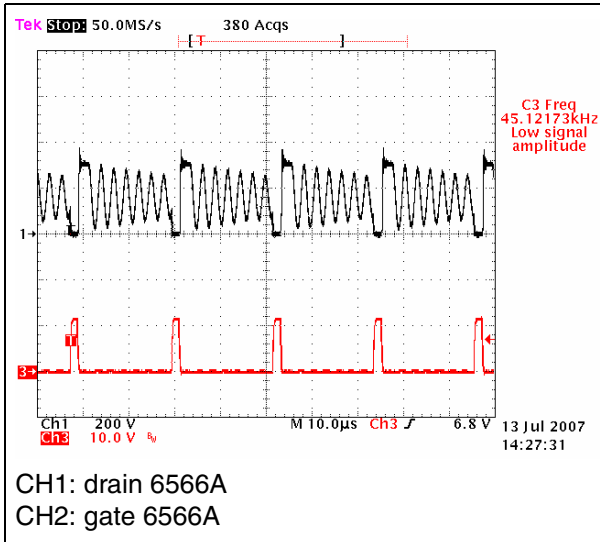
Figure 3. L6566A fly-back stage waveforms at 230 V-50 Hz full load



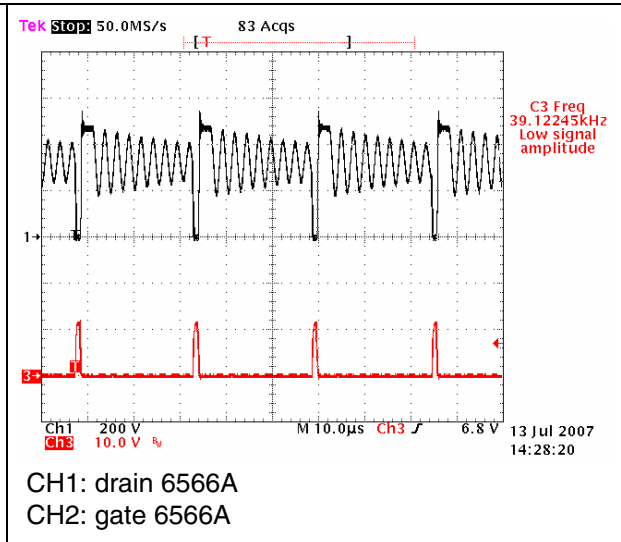
### 3 Light load condition (fold back frequency)

To improve the efficiency at light load, a frequency shifting has been implemented on the board. Thus, at decreasing load, the frequency also decreases. [Figure 4](#) and [Figure 5](#) below show the drain and gate fly-back waveforms and the relevant switching frequency with a load of 0.2 A.

**Figure 4. L6566A fly-back stage waveforms at 115 V-60 Hz 0.2 A**



**Figure 5. L6566A fly-back stage waveforms at 230 V-50 Hz full load**



[Table 2](#) below shows the efficiency when we set the power input with 2.4 or 1.7 W in two different voltage inputs with the fold back network plugged in.

**Table 2. Standby consumption**

Light load condition				
	Vin = 230 V		Vin = 115 V	
Pin	2.40	1.69	2.41	1.71
Pout	1.51	1.06	1.70	1.14
Efficiency	62.9%	62.7%	70.5%	66.7%

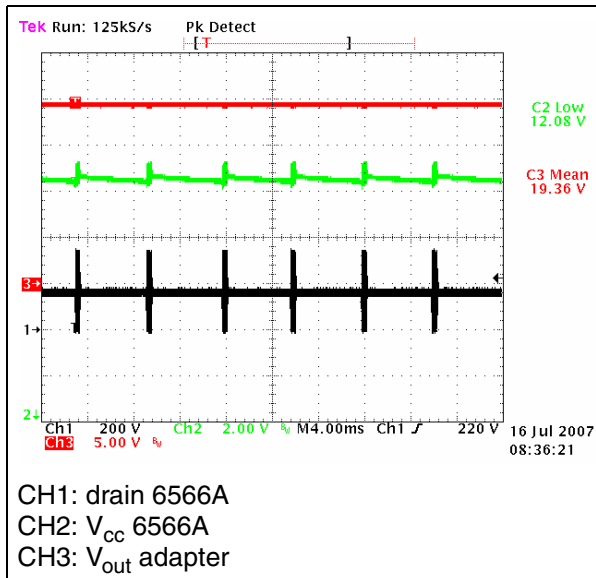
# 4 No-load

Table 3 gives the power consumption of the circuit during no-load operation. Figure 6 and Figure 7 show the main waveforms under this condition.

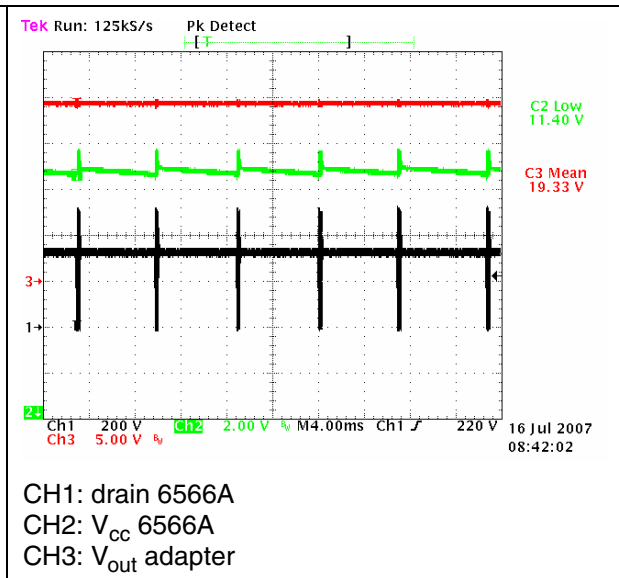
**Table 3. No-load consumption**

Vin [Vrms]	Input power [W]
90	0.94
115	0.107
230	0.202
265	0.260

**Figure 6. L6566A fly-back stage waveforms at 115 V-60 Hz no-load**

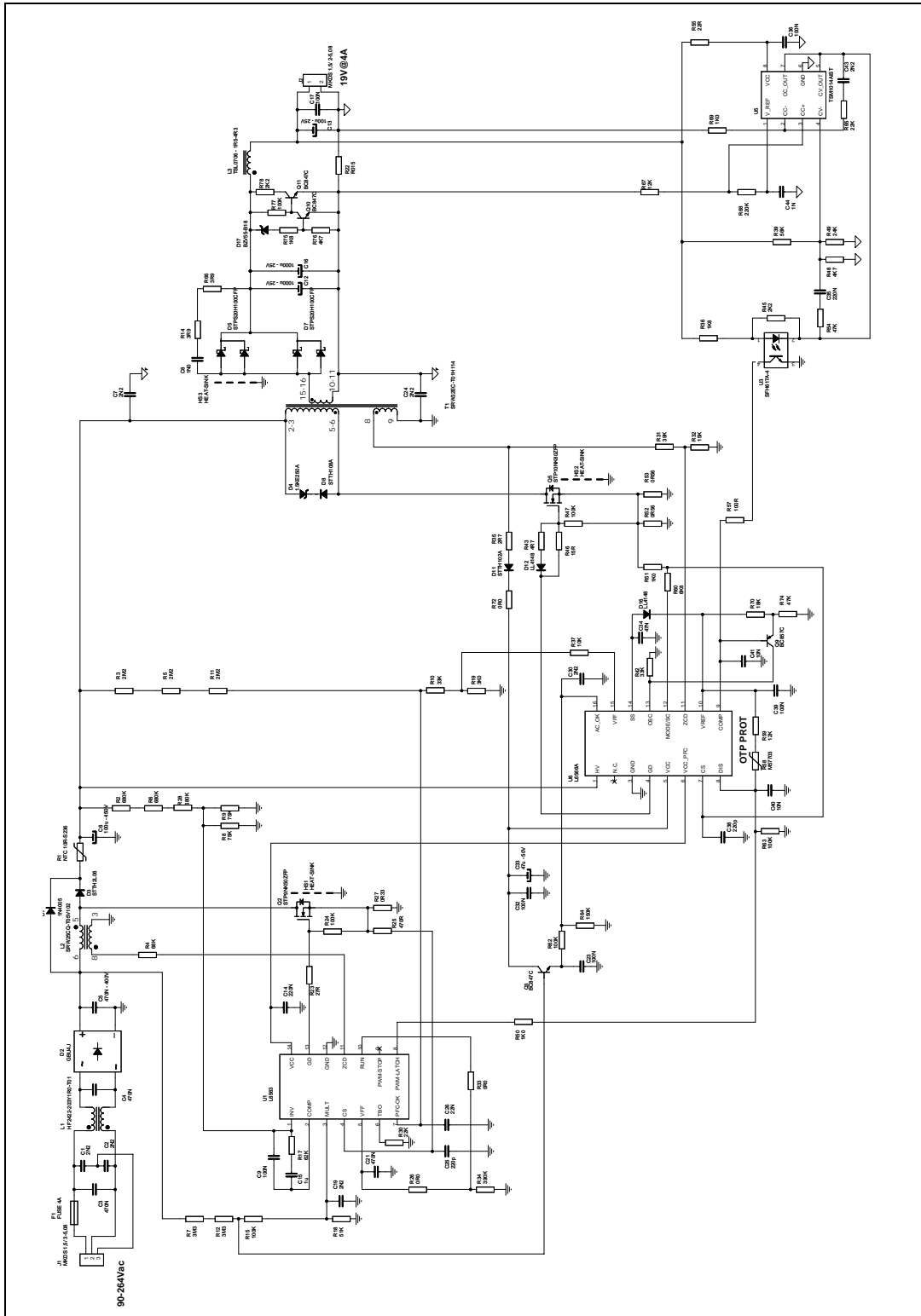


**Figure 7. L6566A fly-back stage waveforms at 230 V-50 Hz no-load**



# 5 Schematic

Figure 8. EVL6562A-TM-80W schematic



## 6 Revision history

**Table 4. Document revision history**

Date	Revision	Changes
28-Sep-2007	1	Initial release

**Please Read Carefully:**

Information in this document is provided solely in connection with ST products. STMicroelectronics NV and its subsidiaries ("ST") reserve the right to make changes, corrections, modifications or improvements, to this document, and the products and services described herein at any time, without notice.

All ST products are sold pursuant to ST's terms and conditions of sale.

Purchasers are solely responsible for the choice, selection and use of the ST products and services described herein, and ST assumes no liability whatsoever relating to the choice, selection or use of the ST products and services described herein.

No license, express or implied, by estoppel or otherwise, to any intellectual property rights is granted under this document. If any part of this document refers to any third party products or services it shall not be deemed a license grant by ST for the use of such third party products or services, or any intellectual property contained therein or considered as a warranty covering the use in any manner whatsoever of such third party products or services or any intellectual property contained therein.

**UNLESS OTHERWISE SET FORTH IN ST'S TERMS AND CONDITIONS OF SALE ST DISCLAIMS ANY EXPRESS OR IMPLIED WARRANTY WITH RESPECT TO THE USE AND/OR SALE OF ST PRODUCTS INCLUDING WITHOUT LIMITATION IMPLIED WARRANTIES OF MERCHANTABILITY, FITNESS FOR A PARTICULAR PURPOSE (AND THEIR EQUIVALENTS UNDER THE LAWS OF ANY JURISDICTION), OR INFRINGEMENT OF ANY PATENT, COPYRIGHT OR OTHER INTELLECTUAL PROPERTY RIGHT.**

**UNLESS EXPRESSLY APPROVED IN WRITING BY AN AUTHORIZED ST REPRESENTATIVE, ST PRODUCTS ARE NOT RECOMMENDED, AUTHORIZED OR WARRANTED FOR USE IN MILITARY, AIR CRAFT, SPACE, LIFE SAVING, OR LIFE SUSTAINING APPLICATIONS, NOR IN PRODUCTS OR SYSTEMS WHERE FAILURE OR MALFUNCTION MAY RESULT IN PERSONAL INJURY, DEATH, OR SEVERE PROPERTY OR ENVIRONMENTAL DAMAGE. ST PRODUCTS WHICH ARE NOT SPECIFIED AS "AUTOMOTIVE GRADE" MAY ONLY BE USED IN AUTOMOTIVE APPLICATIONS AT USER'S OWN RISK.**

Resale of ST products with provisions different from the statements and/or technical features set forth in this document shall immediately void any warranty granted by ST for the ST product or service described herein and shall not create or extend in any manner whatsoever, any liability of ST.

ST and the ST logo are trademarks or registered trademarks of ST in various countries.

Information in this document supersedes and replaces all information previously supplied.

The ST logo is a registered trademark of STMicroelectronics. All other names are the property of their respective owners.

© 2007 STMicroelectronics - All rights reserved

STMicroelectronics group of companies

Australia - Belgium - Brazil - Canada - China - Czech Republic - Finland - France - Germany - Hong Kong - India - Israel - Italy - Japan - Malaysia - Malta - Morocco - Singapore - Spain - Sweden - Switzerland - United Kingdom - United States of America

[www.st.com](http://www.st.com)



## X-ON Electronics

Largest Supplier of Electrical and Electronic Components

*Click to view similar products for [Power Management IC Development Tools](#) category:*

*Click to view products by [STMicroelectronics](#) manufacturer:*

Other Similar products are found below :

[EVAL-ADM1168LQEBZ](#) [EVB-EP5348UI](#) [MIC23451-AAAYFL EV](#) [MIC5281YMME EV](#) [DA9063-EVAL](#) [ADP122-3.3-EVALZ](#) [ADP130-0.8-EVALZ](#) [ADP130-1.2-EVALZ](#) [ADP130-1.5-EVALZ](#) [ADP130-1.8-EVALZ](#) [ADP1714-3.3-EVALZ](#) [ADP1715-3.3-EVALZ](#) [ADP1716-2.5-EVALZ](#) [ADP1740-1.5-EVALZ](#) [ADP1752-1.5-EVALZ](#) [ADP1828LC-EVALZ](#) [ADP1870-0.3-EVALZ](#) [ADP1871-0.6-EVALZ](#) [ADP1873-0.6-EVALZ](#) [ADP1874-0.3-EVALZ](#) [ADP1882-1.0-EVALZ](#) [ADP199CB-EVALZ](#) [ADP2102-1.25-EVALZ](#) [ADP2102-1.875EVALZ](#) [ADP2102-1.8-EVALZ](#) [ADP2102-2-EVALZ](#) [ADP2102-3-EVALZ](#) [ADP2102-4-EVALZ](#) [ADP2106-1.8-EVALZ](#) [ADP2147CB-110EVALZ](#) [AS3606-DB](#) [BQ24010EVM](#) [BQ24075TEVM](#) [BQ24155EVM](#) [BQ24157EVM-697](#) [BQ24160EVM-742](#) [BQ24296MEVM-655](#) [BQ25010EVM](#) [BQ3055EVM](#) [NCV891330PD50GEVB](#) [ISLUSBI2CKIT1Z](#) [LM2744EVAL](#) [LM2854EVAL](#) [LM3658SD-AEV/NOPB](#) [LM3658SDEV/NOPB](#) [LM3691TL-1.8EV/NOPB](#) [LM4510SDEV/NOPB](#) [LM5033SD-EVAL](#) [LP38512TS-1.8EV](#) [EVAL-ADM1186-1MBZ](#)